

Assembly Instructions

Caution : You must read this before you proceed

HANGING CHAIR BASE

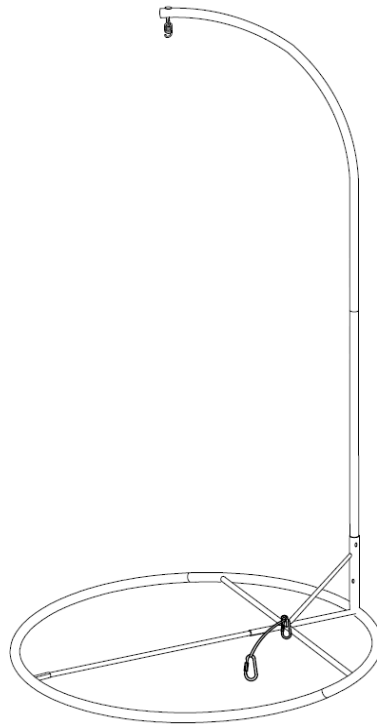





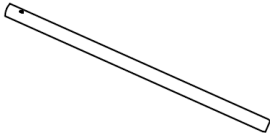
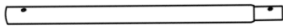
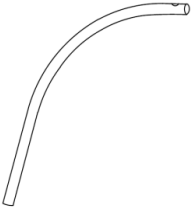



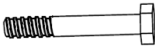

Parts List

Label	Picture	Description	QTY
A	A line drawing of the base part, showing a circular base with a central pivot point and a vertical tube attached to the center.	Base	1
B	A line drawing of the right tube part, showing a curved tube with a hook at one end.	Right Tube	1

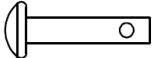
C		Left Tube	1
D		Middle Tube	1
E		Lower Pole	1
F		Upper Pole	1

Hardware

Label	Picture	Description	QTY
①		Hex Bolt (M8x65mm)	3
②		Hex Bolt (M8x55mm)	2
③		Hex Bolt (M8x15mm)	6
④		Washer (M8)	12
⑤		Nut (M8)	4
⑥		Cap (M8)	12
⑦		Hanging Part	1
⑧		Spring	1
⑨		Safety Line (with Carabiner)	1

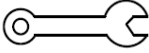
⑩		Rubber Ring	1
⑪		Spanner (M8)	2

Assembly Preparation

Before Beginning Assembly:

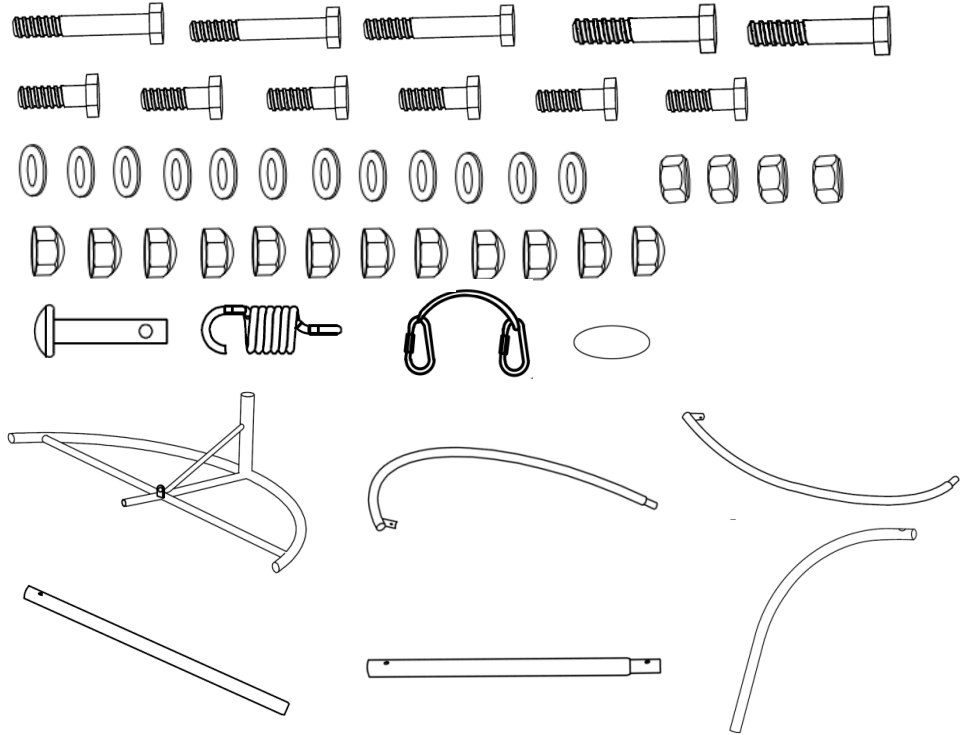

- Read instructions, cover to cover-



- Have 2 adults on hand for assembly-



- Do not assemble on flooring or carpet-



- Assemble on a clean non-marring surface (packing foam)-



- Save all packaging until finished-

Assembly Steps

Overview

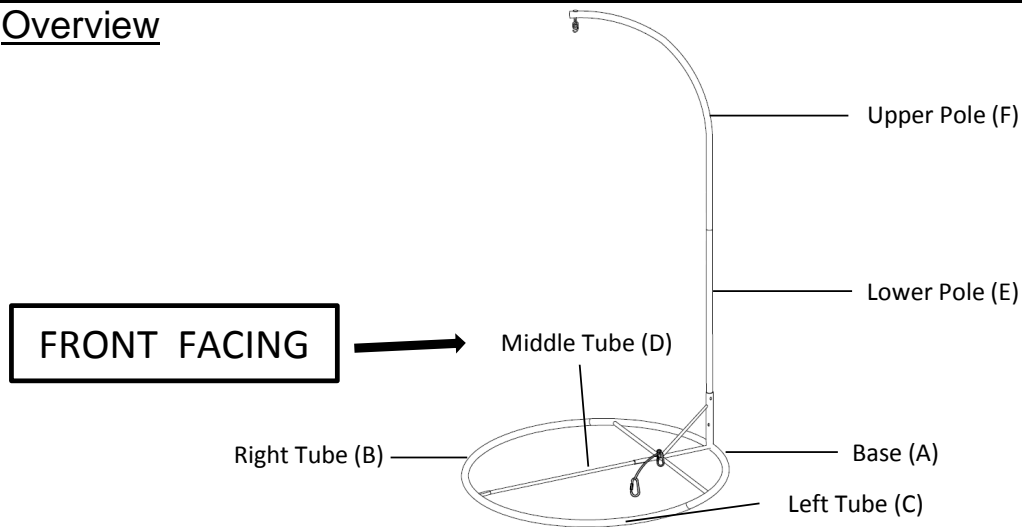

This Hanging Chair Base has multiple parts and may require up to 30 minutes to assemble. To give you an overview of the Hanging Chair Base parts, the above picture is to help you put the various parts into perspective. Please read through the instructions below to familiarise yourself with the parts and steps before assembly.

Step 1

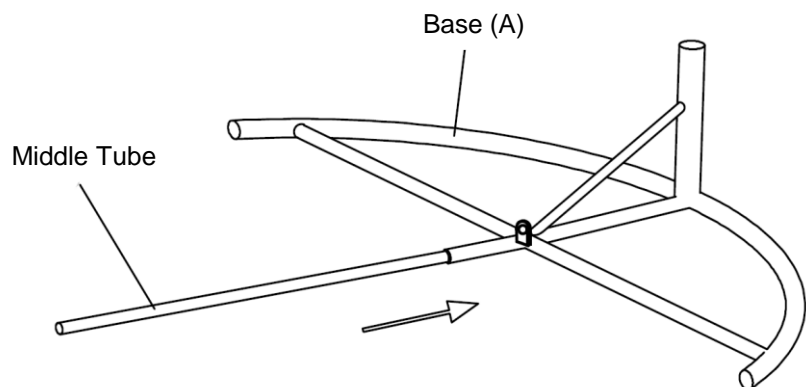

Place the Base(A) and Middle Tube(D) on a clean, non-marring surface. Insert Middle Tube(D) into the Base(A) as pictured.

Step 2

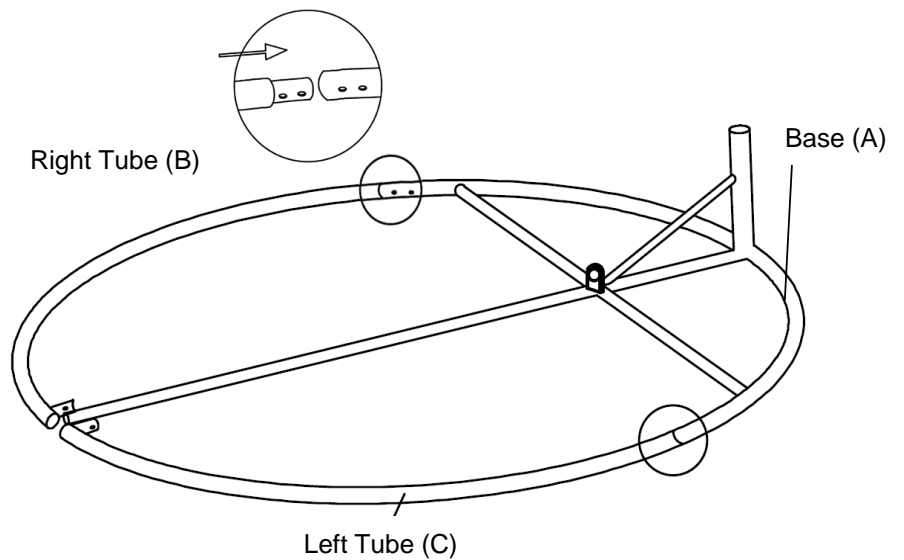

Place the Base(A), Right Tube(B) and Left Tube(C) on a clean, non-marring surface. One by one insert Right Tube(B) and Left Tube(C) into the Base(A).

Step 3

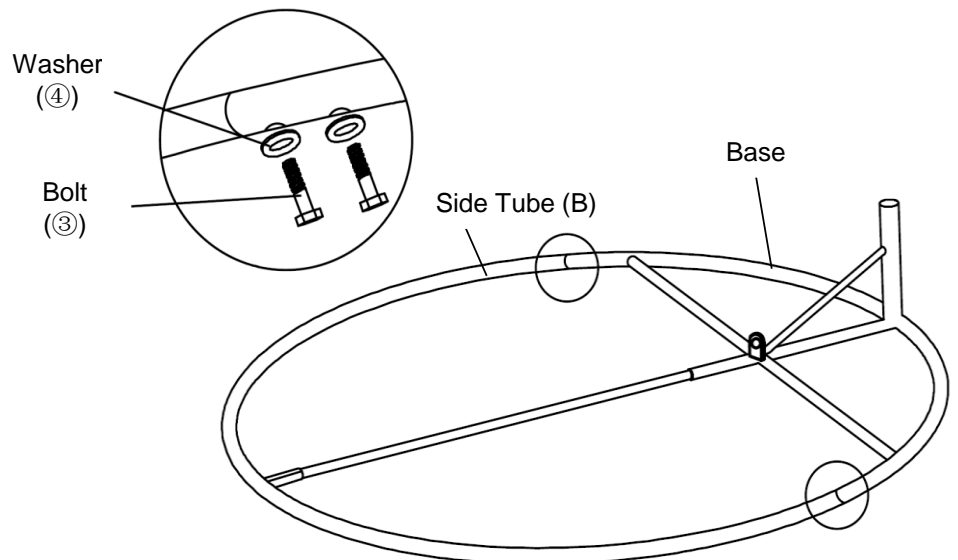

Attach Right Tube(B) and Left Tube(C) to Base(A) using Bolts(3) and Washers(4), with Spanner(11).

Do not fully tighten the Bolts.

Step 4

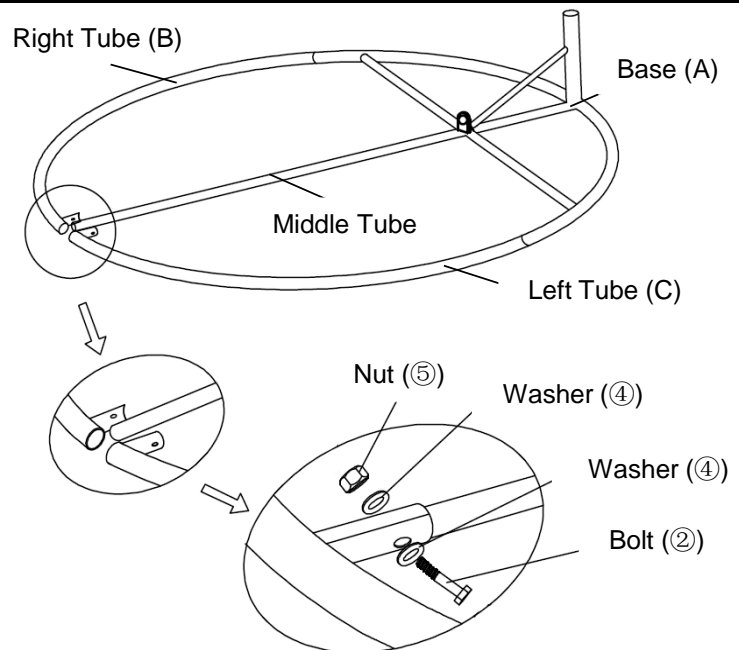

Attach Right Tube(B) and Left Tube(C) to Middle Tube(D) using Bolt(②) and Washer(④) on one side, and using Washer(④) and Nut(⑤) on the other side; tighten with Spanners(⑪).

Do not fully tighten the Bolts.

Step 5

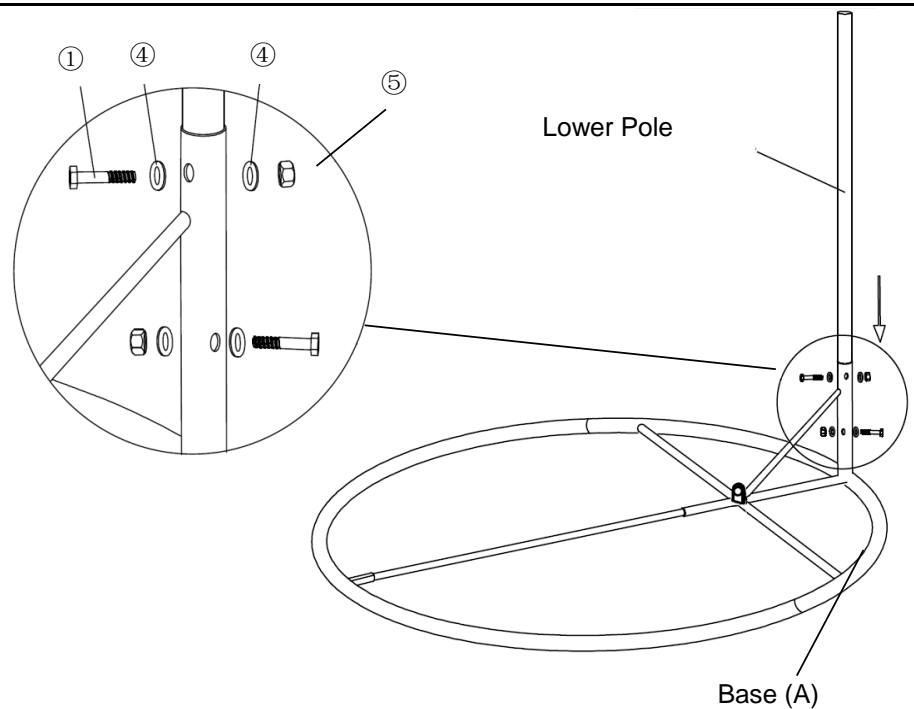

Insert Lower Pole(E) into Base(A), turn the Lower Pole(E) and align mounting positions. Attach Lower Pole(E) to Base(A) using Bolts(①) and Washers(④) on one side, and using Washers(④) and Nuts(⑤) on the other side; tighten with Spanners(⑪).

Do not fully tighten the Bolts.

Step 6

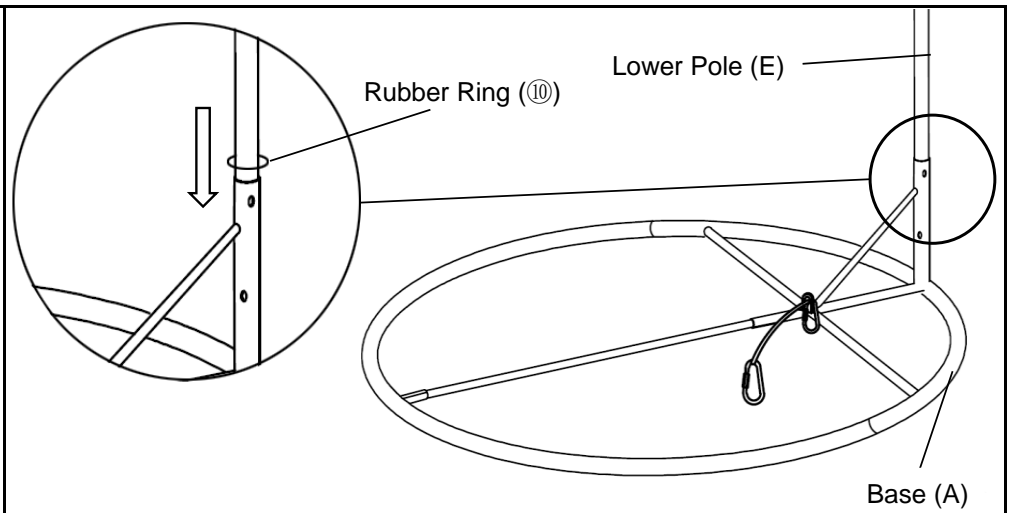

Move the Rubber Ring(⑩) down the Lower Pole(E) until it is flush with the top of the Base(A).

Step 7

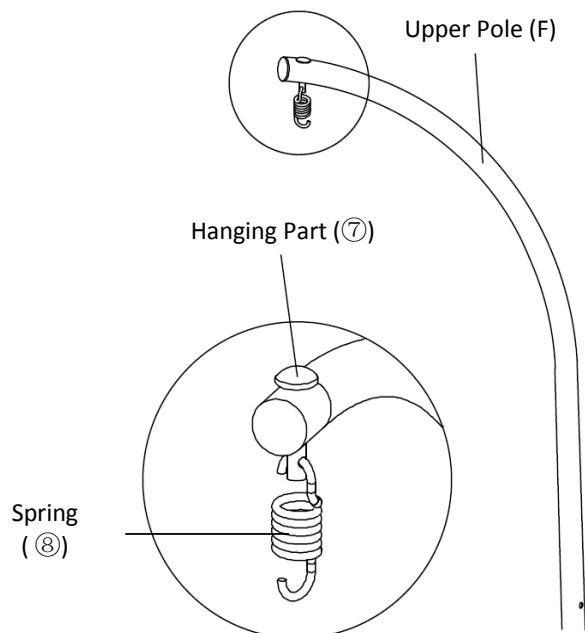

Insert Hanging Part(⑦) into the top of Upper Pole(F).
Then insert the Spring(⑧) into the Hanging Part (⑦).

Step 8

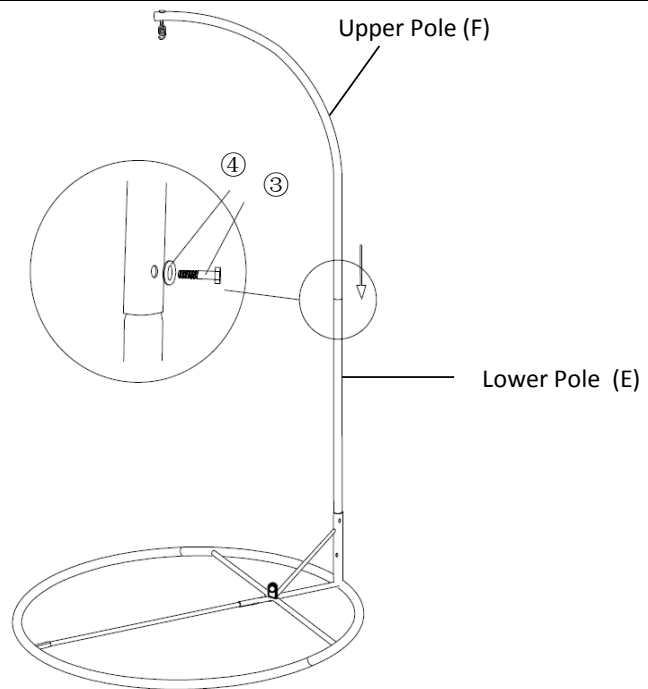

Insert the Upper Pole(F) into Lower Pole(E) and align mounting positions.
Attach Upper Pole(F) to Lower Pole(E) using Bolt(3) and Washer(4) with Spanner(11).
Now, tighten all Bolts and Nuts at all joints sequential manner.
Place Caps(6) on Bolts and Nuts(5).

Step 9

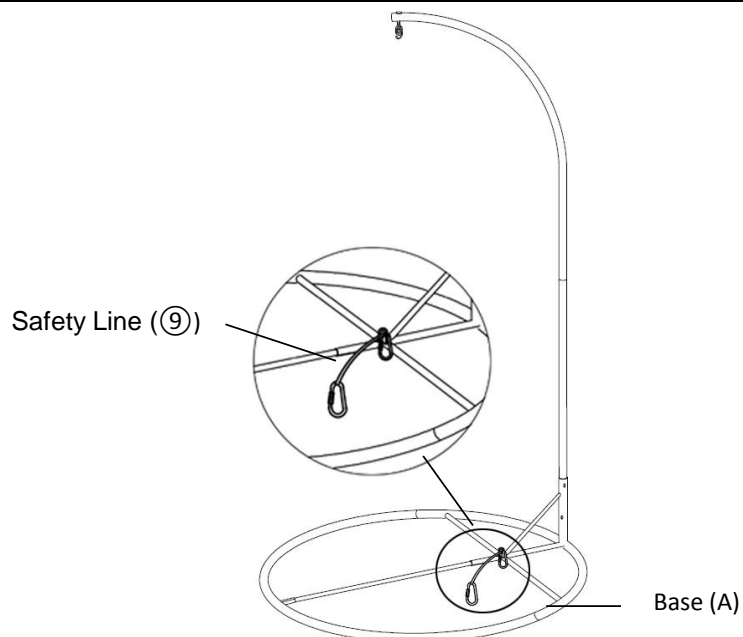

Insert the Carabiner on the Safety Line(9) into the Base(A), and screw up the Carabiner.
Your Hanging Chair Base is ready for use.
This Hanging Chair Base can only be used on a flat, level surface.

Step 10

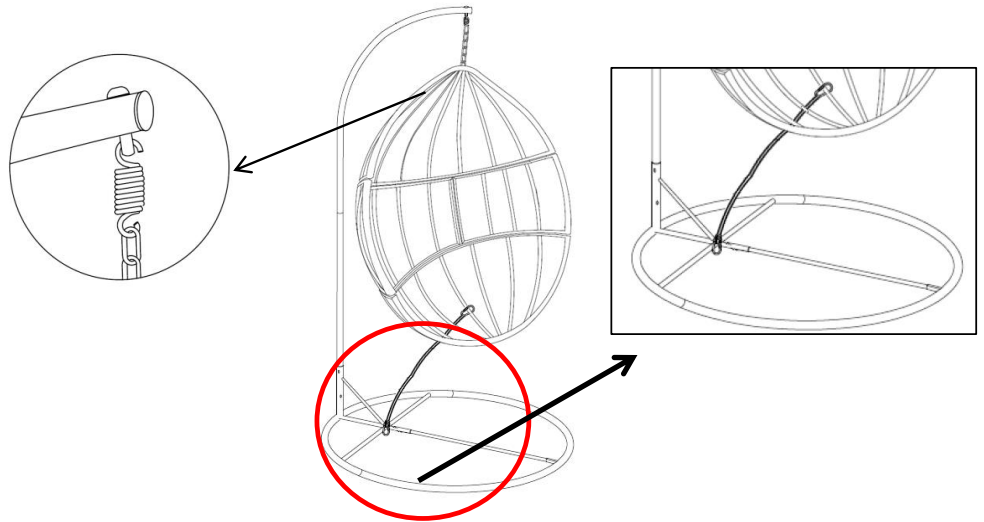





















Lift the Basket and hang the Iron Chain on the Spring of the Hanging Chair Base.
Use the Safety Rope to lock up the middle rattan warp at the bottom of the Basket as shown above.

Screw up the Carabiner to secure the Basket

Note: This Step should be completed with 2 adults.

Care & Maintenance

-   • Do not put hot items directly on furniture surface
 -   • Do not clean furniture with harsh cleansers or polish.
 -   • To obtain the longest lifespan of your outdoor products, minimizing exposure to direct sunlight is recommended.
 -   • Children should not climb or jump on the furniture.
 -   • Do not write on furniture without a padded barrier to protect the surface.
 -   • To obtain the longest lifespan of your outdoor products, avoid extended and lengthy exposure to rain, snow, and direct sunshine. Whenever possible cover the product and /or place under patio or awnings.
 -   • Not for commercial use. For residential use only .
 -   • Stains may be removed with mild soap solution and damp cloth.
 -   • Keep away from sources of ignition.
-
-   • Dust and pick-up spills using a clean, non-colored, lint-free cloth .

What is Proposition 65?

Proposition 65 is a California law that requires warning labels on products that may contain one of more than 800-plus chemicals or ingredients that the California Office of Environmental Health Hazard Assessment (OEHHA) has deemed to cause cancer or other reproductive toxicity. Chemicals and elements on this list include wood dust, brass, and other everyday substances, which can be found in very common household items, such as: lamps, tableware, jewelry, crystal glasses, electric cords, beauty products, automobiles, and furniture.

Why Did I Find a Proposition 65 Warning on My Home Goods Product?

We include Proposition 65 warnings on all of our products because there is always a chance that one of the 800-plus common chemicals and ingredients listed under this law could potentially be on our furniture or packing materials. We risk large fines under this law, if we don't include this warning.

Should I worry?

We realize you may be worried finding this warning on our products, but we want to reassure you that the hazardous exposure limits for any of these chemicals have never been found on furniture products that we've shipped to our customers. Additionally, this warning label is very common and can be found on almost every piece of furniture sold in the state of California.

Just How Common Are Proposition 65 Warnings?

Proposition 65 warnings have become so common in California that it is hard to take a trip to a local bank, grocery store, or restaurant without finding at least one warning. In fact, even the Disney Land Resort has a Proposition 65 warning:

