

Owner Manual

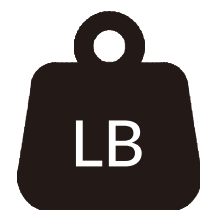
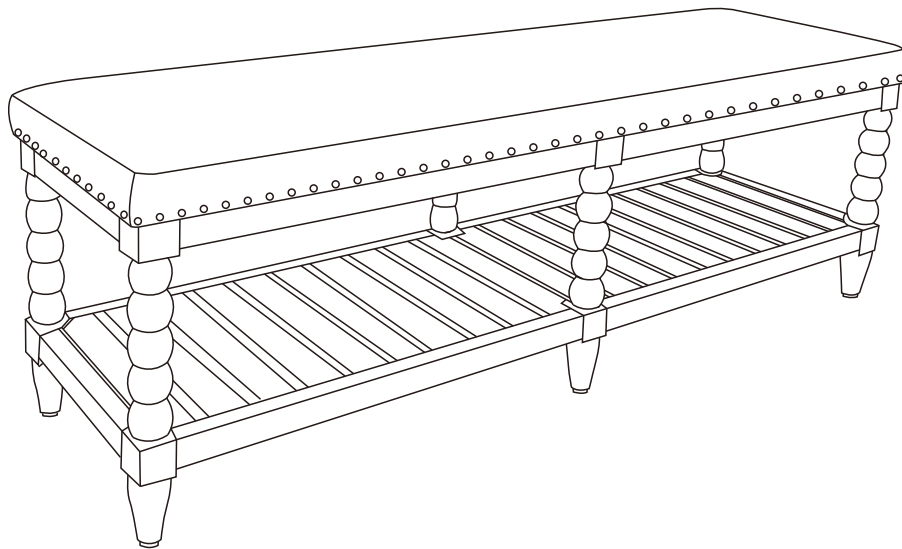

Per Seat Weight Limitation

500 LBS

Thank You For Choosing Our Furniture

**If you have any questions or concerns,
don't hesitate to reach out to us.**

NOTE:

**This brochure contains
IMPORTANT safety
info.**







**Please read and keep it
for future reference.**

MAINTAINANCE AND WARNINGS



Before You Start

Please follow the steps below:



-  **Un box the package and check if all parts and accessories are complete.**
-  **Place the parts of the chair on a flat surface.**
-  **Ensure the chair is placed on a stable, flat surface to prevent it from tilting.**
-  **Avoid placing sharp or heavy objects directly on the chair to prevent tears or deformation.**
-  **Clean the installation area in advance and ensure the ground is level and there is enough space to avoid damaging the furniture or making installation difficult.**
-  **Lay a protective mat on the ground to prevent scratching the floor during installation.**

After-Sales Service

- **If you encounter any issues or need technical support during use, please contact our after-sales team. We offer long-term maintenance and warranty services.**





Precautions

-  **This chair is for indoor use only. Do not expose it to outdoor elements or high-humidity environments.**
-  **Keep the product away from high heat or open flames to prevent fire hazards.**
-  **Do not allow children or pets to play on the chair unsupervised to avoid accidents.**



Safety Warnings

-  **If you notice any loose or damaged parts, stop using the sofa immediately and contact customer service.**
-  **Do not attempt to disassemble or replace any components yourself, as this may affect the stability and safety of the product.**

Daily Maintenance

- **Regularly clean the surface of the sofa with a chair cloth to prevent dust accumulation.**
- **For fabric chairs, it is recommended to vacuum weekly and clean the fabric as needed.**
For leather chairs, use a leather cleaner regularly to clean and maintain the material.
- **Avoid direct sunlight to prevent leather aging.**
- **In case of spills, immediately blot the area with a clean, dry cloth**

Parts List

A

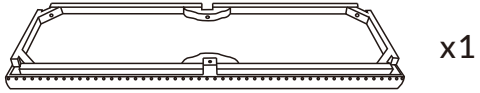

Seat palte

B

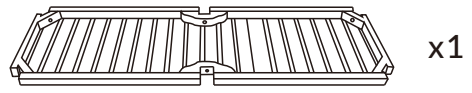

Pallets

C



Sides leg

D



Middle leg





Installation:
15minutes.



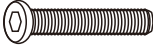

Two Person

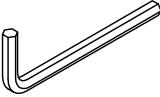
Hardware List

<p>1</p>  x12+1 M8x45mm	<p>2</p>  x12+1 M9x14mm	<p>3</p>  x12+1 M9x11mm
<p>4</p>  x1 M6		

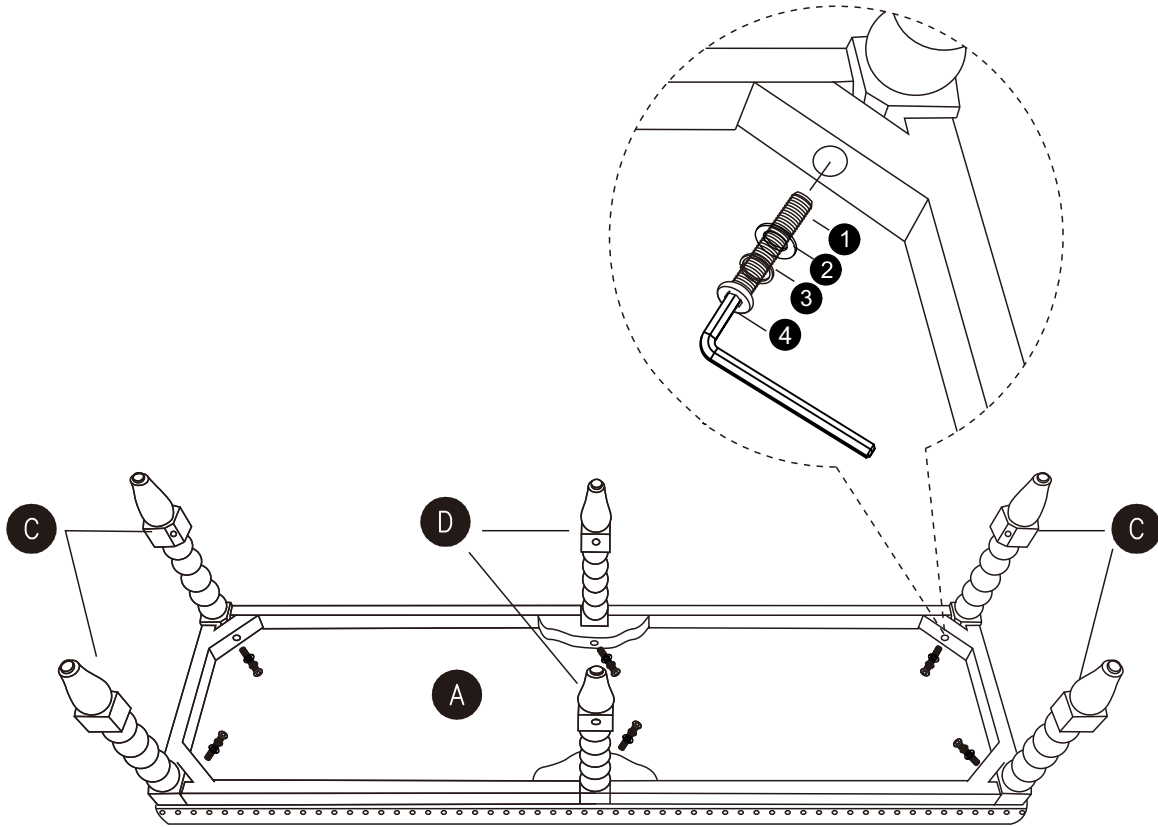
Step 1





C	x4
	
Sides leg	

D	x2
	
Middle leg	

1	x6
	
M6x45mm	





2	x6
	
M9x11mm	

3	x6
	
M9x14mm	

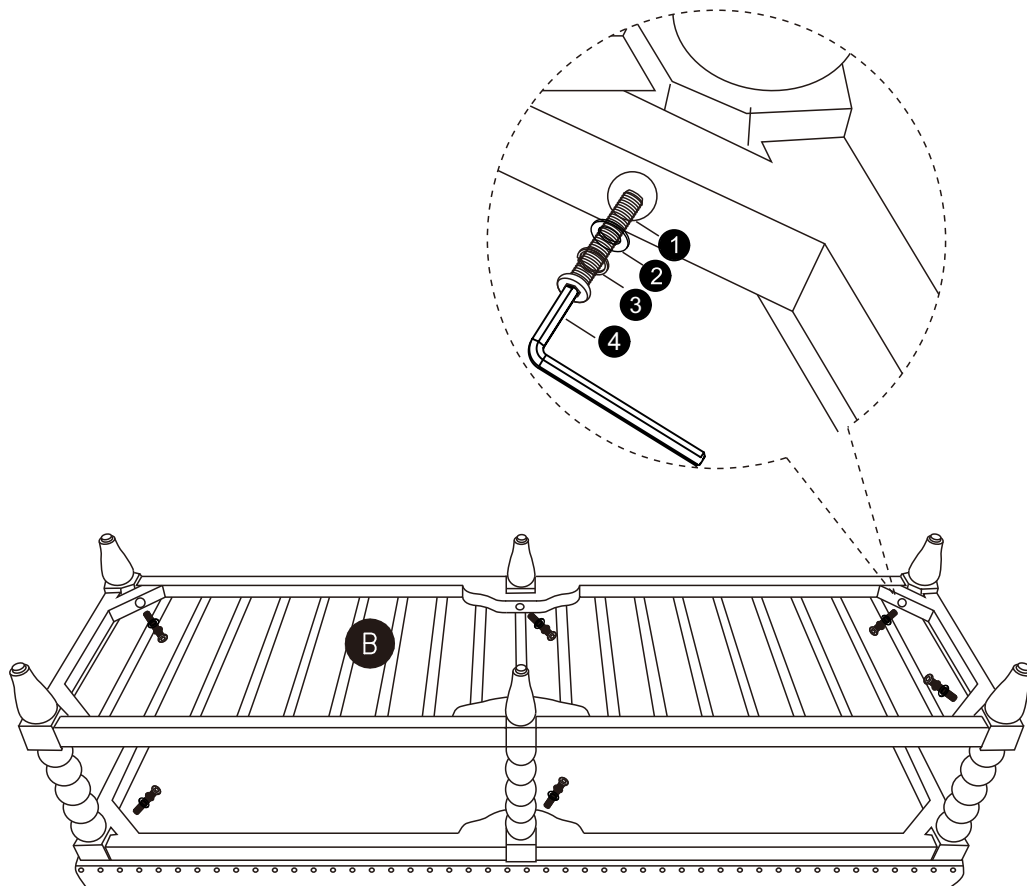
4	x1
	
M6	

Step 2



1	x6	2	x6	3	x6	4	x1
							
M6x45mm		M9x11mm		M9x14mm		M6	

Step 3

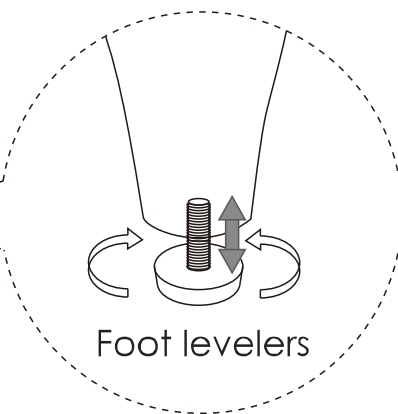
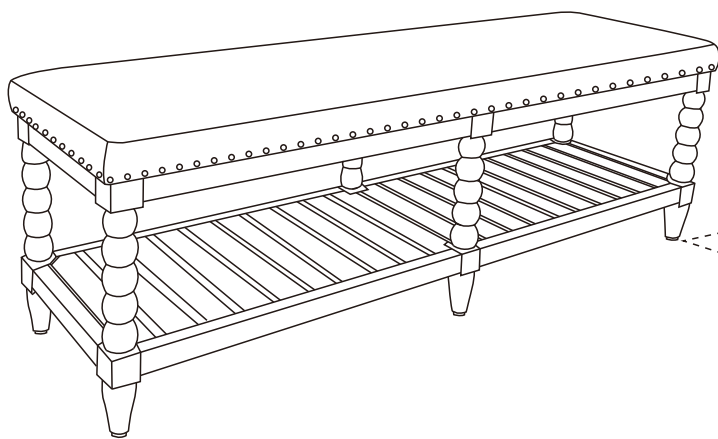

WARRANTY

- **We strive to offer quality products, and we also try our best to satisfy every customer who orders from us with products or services as needed.**

- **We provide 30 days warranty starting from the time you receive the item. Each customer must provide a record of their orders such as the order number, or item receipt for any items that are out of the warranty period you may also still receive.**

- **Replacement parts by purchasing them from our company if they are available.**

- **For return, please check the return policy with the retailer or market place you bought from**