

# ASSEMBLY INSTRUCTIONS

## Raleigh Retro Dining Table Item# 64517WHT

ASSEMBLY  
REQUIREMENTS

2-Person  
Assembly

30 Minutes  
Assembly Time  
(Approximate)

### Thank you for purchasing our product!

Please refer and use this assembly instruction to assemble the product. Contact our customer service department in case there are any missing or damage parts or hardware. Replacement parts are normally shipped within 2 or 3 days.

Email: [replacementparts@buylateral.com](mailto:replacementparts@buylateral.com)  
Within 30 days from delivery date

Products purchased through our authorized vendors only are eligible for replacement parts .

**THIS PRODUCT IS FOR INDOOR AND  
HOUSEHOLD USE ONLY- NOT FOR  
COMMERCIAL USE.**



### ASSEMBLY PREPARATION

1. Remove all packaging materials, staples and packing straps from the carton.
2. Refer to Parts List and Hardware List, and ensure parts and hardware are correct before assembly.  
Contact customer service for missing parts.
3. Place all wooden parts on a clean, flat and soft surface (e.g. carpet or rug) to prevent parts from getting scratched.

### SAFETY PRECAUTION

1. KEEP ALL HARDWARE PARTS OUT OF REACH OF CHILDREN.
2. DISPOSE PLASTIC PACKAGING MATERIAL IMMEDIATELY TO AVOID ANY RISK OF SUFFOCATION TO CHILDREN AND ANIMALS.

### TIPS FOR ASSEMBLY

1. Allow ample room for assembly and in close proximity to where product will be placed.
2. Assemble the product on a surface that does not scratch or damage the exterior gloss and finish of the furniture.
3. Identify all of the parts, hardware and quantities required for each step.
4. During assembly, do not over-tighten any fittings as this may cause damage.
5. DO NOT USE POWER TOOLS TO ASSEMBLE THIS PRODUCT.
6. Always place the product on a flat, level surface.
7. Do not sit or stand on the partially assembled product; only use the product for which it is intended.







### CARE AND MAINTENANCE







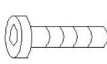

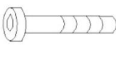
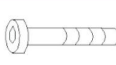
- Wipe clean with a soft, dry cloth; avoid the use of harsh chemicals or household cleaners as they may damage the exterior finish of the furniture.
- Hardware may loosen over time. Periodically, check that all connections are tight; re-tighten as necessary.
- Solid wood is impacted by heat and humidity fluctuations which may cause small joint separations or hairline cracks; place the furniture away from direct sunlight and air conditioning vents, heating vents or units to protect the furniture.

# ASSEMBLY INSTRUCTIONS

## Raleigh Retro Dining Table Item# 64517WHT

### Parts and Hardware

ITEM	DISCRIPTION	PART	QTY
1	Table Top		1 pc
2	Metal Plate		1 pc
3	Table Leg		1 pc
4	Table Base		1 pc
A	Screw 10x40mm		3 pcs
B	Screw 6x12mm		4 pcs
C	Screw 10x90mm		1 pc
D	Screw 6x85mm		1 pc

ITEM	DISCRIPTION	PART	QTY
E	Spring Washer M6		1 pc
F	Spring Washer M10		1 pc
G	Flat Washer M6		1 pc
H	Flat Washer M10		4 pcs
I	Screw Plate		1 pc
J	Spacer		1 pc
K	Allen Key M4		1 pc
L	Allen Key M8		1 pc

#### STEP 1

a) Position Table Leg (3) with the 4 screw holes on one end facing up as shown.

b) Place Metal Plate (2) to align the 3 screw holes at the center to the 3 screw holes on (3).

c) Use Screw (A) fitted with Flat Washer (H) to fasten (2) to (3). Use Allen Key (L) to drive (A). Do not tighten (A) completely until all 3 screws are in place.

#### STEP 2

a) Lay Table Top (1) bottom-side up as shown.

b) Align the 4 screw holes on Metal Plate (2) to the 4 screw holes on (1).

c) Use Screw (B) to fasten (2) to (1). Use Allen Key (K) to drive (B). Do not tighten (B) completely until all 4 screws are in place.

# ASSEMBLY INSTRUCTIONS

## Raleigh Retro Dining Table Item# 64517WHT

### STEP 3

- a) Attach Spacer (J) to Table Leg (3).
- b) Fit Screw Plate (I) to Table Base (4) and place (4) over (J).
- c) Check that all of the screw holes on each part are aligned.
- d) Use Screw(C/D) fitted with Spring Washer(F/E) and Flat Washer(H/G) to fasten (4) to (3).
- e) Use Allen Key (L/K) to drive and tighten Screw (C/D) completely.

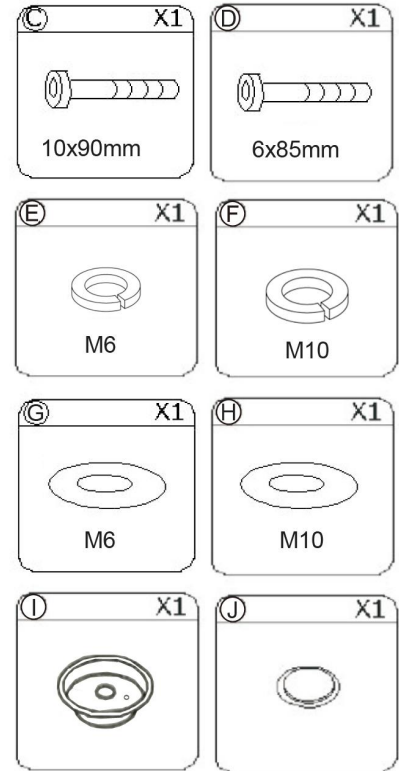
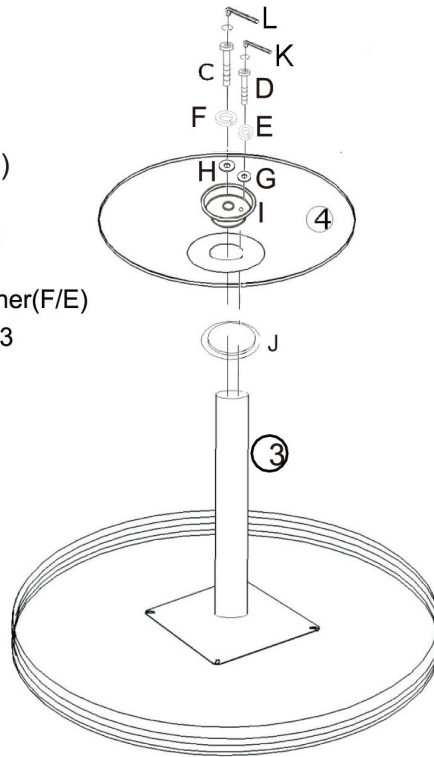

### STEP 4

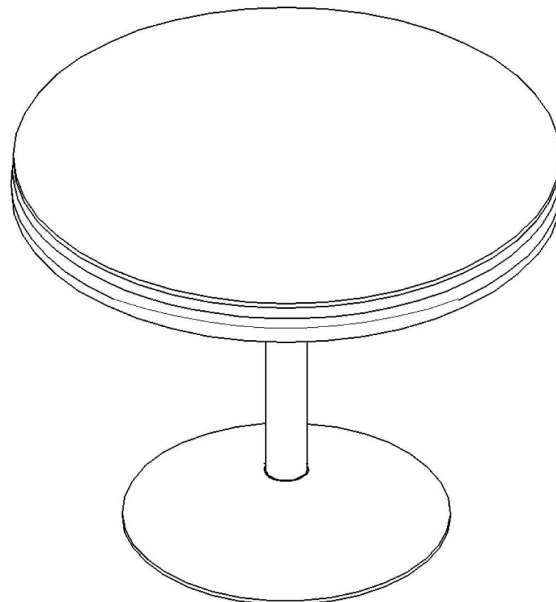

With assistance, set the table right-side up.

The assembly of the table is complete.