

# INSTRUCTION MANUAL

## OPT06 Smart Toilet

**Thank you for choosing our product!**

To ensure proper installation and safe use of your smart toilet, please read this manual carefully.  
If you encounter any missing or damaged parts, please contact our customer service team.  
Be sure to include your Order ID for faster service.

### **Customer Service Contact**

 **Email: [customerservice@hkfoam.com](mailto:customerservice@hkfoam.com)**

 **Response Time: Within 24 hours**

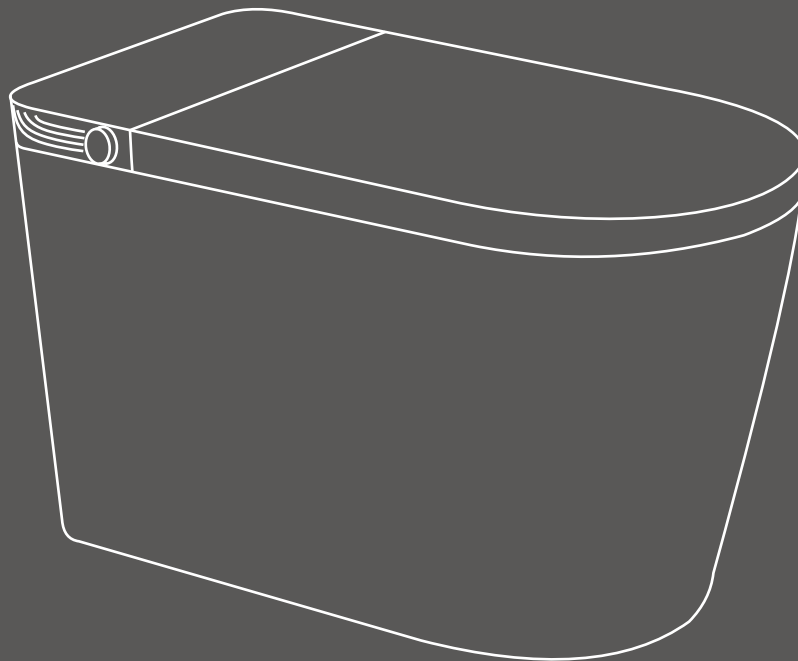

# Catalogue

For any questions or support, please email: [customerservice@hkfoam.com]  
We're here for you: [customerservice@hkfoam.com]





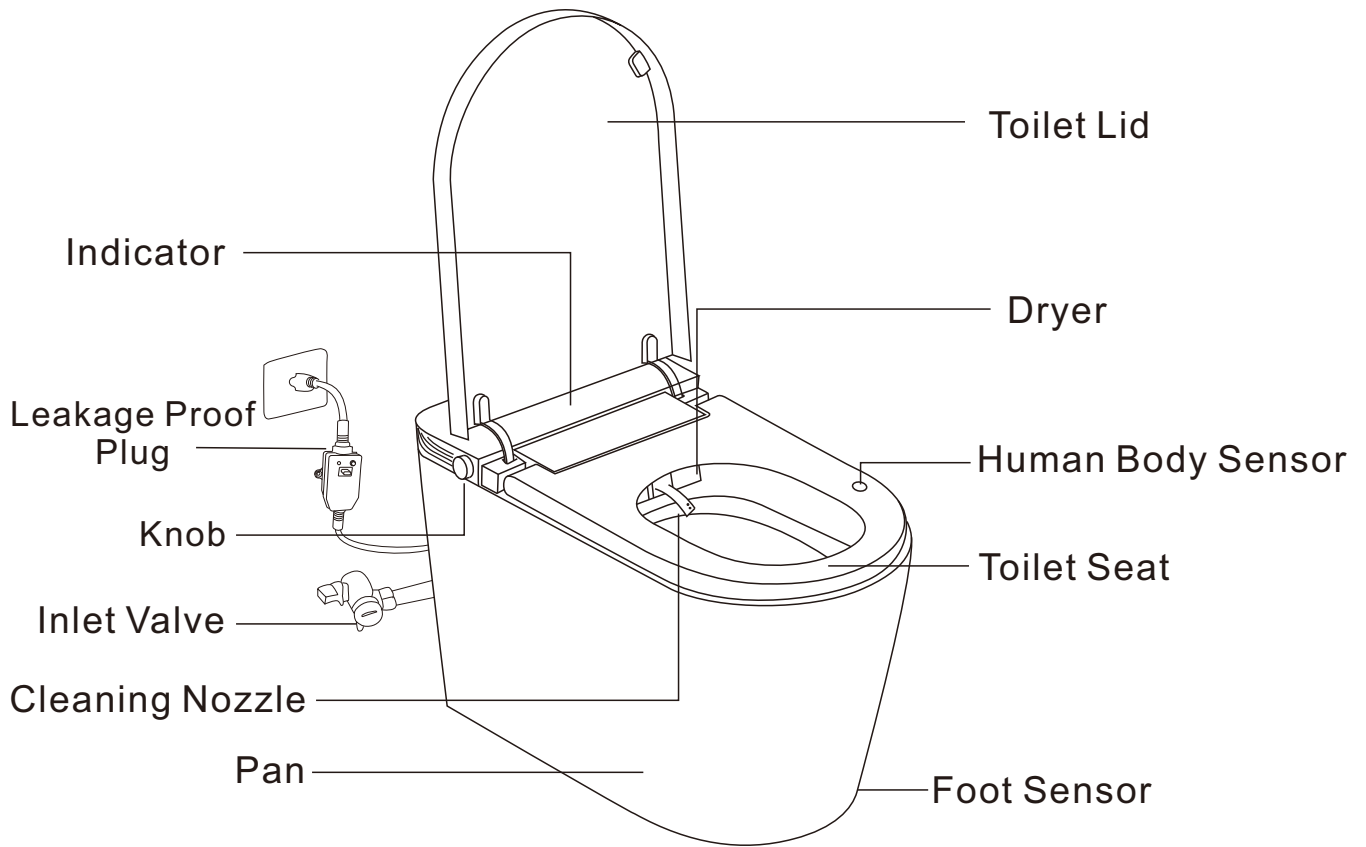

<b>Component name</b>	<b>02</b>
<b>Hardware list</b>	<b>02</b>
<b>Safety directory</b>	<b>03</b>
<b>Smart toilet initial use inspection items</b>	<b>03</b>
<b>Safety caution</b>	<b>04</b>
<b>Please be sure to observe the following</b>	<b>04</b>
<b>Safety and prohibited matters</b>	<b>05</b>
<b>Daily cleaning and maintenance</b>	<b>06</b>
<b>Foot sensor user guide</b>	<b>06</b>
<b>Side knob instructions</b>	<b>07</b>
<b>Remote control operation steps and function guide</b>	<b>08</b>
<b>Common fault diagnosis</b>	<b>10</b>
<b>Installation steps for smart toilet</b>	<b>11</b>
<b>Battery replacement and installation</b>	<b>12</b>
<b>Product standard</b>	<b>13</b>

**Component name**



**Hardware List**

Please check if all accessories listed below have been received.

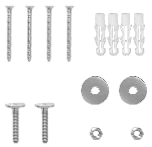
1pcs	1pcs	1pcs	1pcs	1pcs	1pc	1set
						
flange ring	instruction	angle valve	remote control battery	power outage flushing battery	fixed disk	fixed disk screws
<b>A</b>	<b>B</b>	<b>C</b>	<b>D</b>	<b>E</b>	<b>F</b>	<b>G</b>

**Warning-To avoid electric shock** 

1. Do not place the product where it may get wet.
2. Do not drop the remote control into the water.
3. Do not spray water into the product or plug.

**Warning: To prevent the possibility of burns, electric shocks, fires and injuries.** 

1. Young children, temperature insensitive users, when using this product, should be accompanied by others. And turn off or lower the seat temperature.
2. The product is limited to the function on the manual, do not use other equipments.
3. Do not continue to use when the product is out of order, damaged or flooded. Please send the product to the designated repair center for repair.
4. Please make sure that the wires are not damaged by burning.
5. Do not use this product when you are out of your mind.
6. Do not plug the product or pipe.
7. Do not used outdoors.

**Smart toilet initial use inspection items**

Note: To ensure the normal use of the product, please follow the instructions to text.

1. Insert the power plug into the AC 110V socket
2. Please confirm whether the indicator of the digital display panel is lit
3. Confirm whether the inlet valve is take on
4. Whether the hose between the wall Angle valve and the toilet inlet valve is installed in place

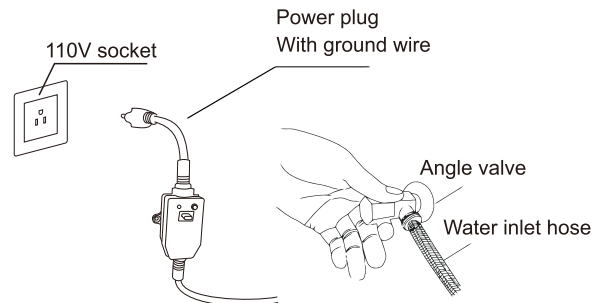

**Caution-Confirmed matters before using**

1. Check whether the sprinkler head and water pipe leak, dry all parts of the water pipe and check with blotting paper.
2. Press the seat around the seat sensor, whether there is a sound.
3. Check whether the cleaning, drying, and automatic flushing are normal
4. Whether the Damped structure is normal.

Check the functions of cleaning, drying, make sure the sensor is on. When cleaning, cover and block the spray nozzle, so as not to splash.

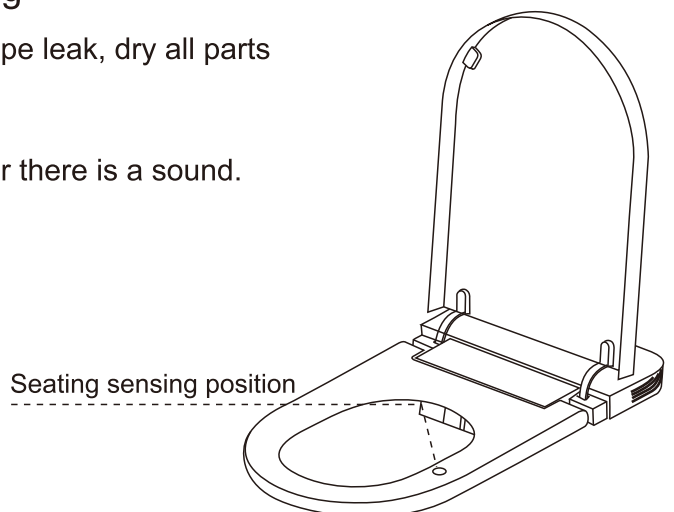

## Safety caution

Note: please cautiously read before using

Please read carefully before using. The cautions listed here are related to safety and please follow. 

This product is an electrical product. Please do not install it in a place where it is easy to be splashed by water or high humidity. When using in the bathroom, please install a vent to keep good air flow in the bathroom.

The socket for power distribution should be set as follows

- The gearing position of electric outlet please to give examples 0.3 min the ground above, and leave bathtub as far as possible a little bit farer.
- The back track of electric outlet please use a high feeling and rapid type electric leakage switch (the sum certainly responds the electric current 15 mA following) or use to insulate the transformer 1.5 KVA above, the 3 KVA is following)carry on a protection.

Warning - Be sure to firmly connect ground wires 

The power plug of this product is a three-phase plug (with ground wire). There is a danger of electric shock when there is a fault or leakage of electricity. If there is no ground plug in the socket, consult with the electrical installation company. Do not use power supply other than AC 110V, please wiring according to relevant regulations.

 The product connects a ground of line to carry on to connect a ground of processing, if has never carried on to connect a ground of processing, may arouses to get an electric shock.

Note: the grounding treatment mentioned here means that the grounding resistance is below 100Ω, and the grounding wires of the switchboard shall be copper wires with a diameter of more than 1.6mm.

While using in the bathroom please confirm the power plug have already used silica gel to carry on a waterproof processing.

\*Using the wrong power supply can easily cause fire\*

Please be sure to observe the following 

Please don't sprinkle urine at the essence and spray.  
Pull out the plug when it thunders.  
Strictly forbid to directly flush with water.  
Please do not wipe seat and cover with dry cloth or toilet paper.

Please do not open the seat ring or cover violently.  
- May cause cracking or malfunction.



Please take antifreeze measures to prevent damage caused by freezing.



Please do not put heaters near this product.  
- Discoloration or malfunction will occur

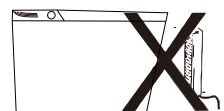

Please read carefully before using.  
The cautions listed here are related to safety and please follow.



Must obey

**Notice heat burn**

- Please turn the seat temperature down or off when sitting on the toilet for a long time.
- Please set the temperature to room temperature when the following persons use the seat to dry gently.

- Children, the elderly, the sick, the disabled, etc.
- People who take sleeping pills, get drunk and get overtired.

**Do not use any power source other than AC 110V**

- It may start a fire

**Keep cigarettes and other fire kindling away from the product**

- It may start a fire

**Please don't sprinkle water or rinse on product essence or the power plug.**

- May arouse a fire or get an electric shock
- May cause toilet break, damage or indoor seepage.

**When long time didn't use, please pull out the power plug.**

- For safety, please pull out the power plug
- For re-use, please drain water for one minute before use.

**Please do not flush other items except for urine and feces**

- May cause then block, sewage outside overflows.

**Do not unplug the power plug with wet hands**

- It may cause electric shock

**Do not distort or damage the water inlet**

- It may cause a leak

**Do not use loose and unstable power sockets**

- It may cause fire or electric shock



Prohibit

**Do not continue to use the product when it breaks down**

When the following occurs, please unplug the power plug, close the inlet Angle valve, stop the inlet.

- Ceramic WC is leaking
- Cracks appear
- Abnormal sound and smell
- Fume-off
- Abnormal heating
- The toilet is clogged

- If continued under the condition of failure, it may cause fire, electric shock or indoor seepage problems

**Do not damage the power cord or toilet seat cable**

- Don't pull
- Don't process
- Don't heat
- Don't forcibly bent
- Do not place heavy objects on the power cord and toilet seat connection line.

- May cause fire, electric shock or short circuit. If the power supply is damaged, please contact a professional for repair.

**Do not disassemble, repair or transform the product without permission**

- It may cause a fire or electric shock

**Do not use extension wires. otherwise, it may cause a fire or electric shock**

- Do not connect wires or use extension cords, which may cause fire and electric shock.

**Do not install this product in damp places such as bathrooms**

- It may cause a fire or electric shock

**Do not use unhealthy water**

- May cause skin irritation and other problems

## Daily cleaning and maintenance

Note: During cleaning and maintenance, please be sure to unplug the power switch and power off

### Smart toilet cleaning and maintenance methods

Please wipe it with a soft cloth dampened with water

- If the dirt is not removed in time, it will become difficult to clean, please wipe with water sometimes.
- Static electricity will absorb dust, resulting in the product black, dirty, water wipe can prevent the generation of static electricity.
- The ceramic body can be removed from the toilet seat to facilitate cleaning between the toilet seat and the ceramic body.

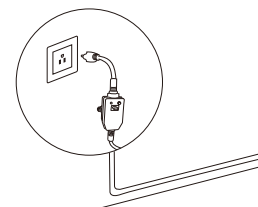

Unplug the power supply before maintenance

### Cleaning and maintenance of spray head

If there is dirt in the nozzle. Please clean it with a small brush such as a toothbrush.

- Do not stretch and bend the spray head.

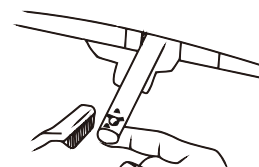

Must obey

#### Clean the dust on the power plug regularly

When cleaning, remove the power plug and wipe with a dry cleaning cloth.

- Poor insulation may cause a fire.



#### Must obey

Hip washing, women's washing, and drying require seating before use

## Foot sensor user guide

Note: Please read the following carefully before use

**Tip: The toilet foot sensor is not sensitive to darker colors or fails to sense. It is recommended to wear light-colored socks and shoes.**

### Open cover and seat by foot sensor

Close to the foot sensor, automatically open/close cover and seat (automatic flip cover)



### Radar automatic flip cover version

The cover opens automatically when people get close to it. The flushing automatically starts after the person leaving the seat, and cover closes automatically after the person leaves the seat for a while.



### Men's urinating operation

1. Put your feet in front of the (Foot Sensor) and the toilet lid will automatically flip up.
2. Put your feet in front of the (Foot Sensor) again and the toilet seat will automatically flip up.
3. The first situation: When you finish using, the toilet seat and toilet lid will automatically close and flush 90 seconds after you leave.

The second situation: when you put your foot in front of the (Foot Sensor) sensor, the toilet seat will automatically flip up. It takes more than 15 seconds during use. Then put your foot in front of the (Foot Sensor) sensor, the toilet seat and toilet lid closes automatically and flushes.

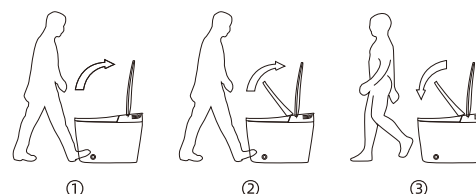

## Side knob instructions

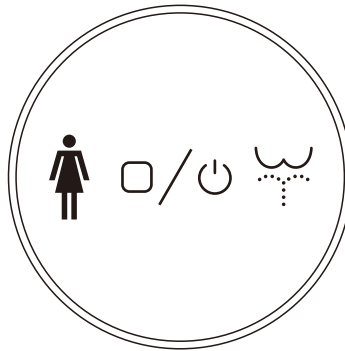

**Hip Cleaning:** This function requires you to sit on the toilet seat, rotate it clockwise once (Knob), the (Cleaning Nozzle) will move out and start hip cleaning, and then rotate it clockwise again (Knob), and the (Cleaning Nozzle) will start moving and cleaning. After 150 seconds, hip cleaning will automatically stop, or press it (Knob).



**Female Cleaning:** This function requires you to sit on the toilet seat, rotate it counterclockwise once (Knob), the (Cleaning Nozzle) will move out and start female cleaning, and rotate it counterclockwise again (Knob), and the (Cleaning Nozzle) will start moving and cleaning. After 150 seconds, female cleaning will automatically stop, or press (Knob).

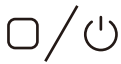

1. When you are using functions such as buttock cleaning or female cleaning or drying. Press this button to stop these functions in use.
2. When you are not sitting down and are not using other functions, press this button to start flushing the toilet.
3. Press and hold this button for more than 5 seconds and the toilet will enter the shutdown state.
4. Power outage flushing: If you install a backup battery when there is no electricity, press this button to flush the toilet.



**Warm air drying:** This function requires you to sit on the toilet seat and press this button for 3 seconds, the toilet will automatically flush once, and then start the warm air drying function. After 240 seconds, the warm air drying will automatically stop, or you can press again (Knob).

## Description of commonly used special functions

### 1. Automatically open the toilet lid - on/off setting instructions:

When the human body walks to the front of the toilet, the toilet lid will automatically open. If this function is not required, please follow the following steps: Press and hold the (REAR) button on the remote control and hear one sound (DI) → off, and hear two sounds (DI, DI) → on. (If this function is turned off, you can open the toilet lid via the foot sensor or the remote control.

### 2. Automatically close the toilet cover and toilet seat - on/off setting instructions:

After using the toilet, the toilet cover and toilet seat will automatically close. If this function is not required, please follow the following steps: Press the (STOP) button on the remote control, and the toilet will enter the shutdown state, press the (NIGHT LAMP) button on the remote control, hear a long sound (DI) → turn on, and hear a short sound (DI) → turn off. Then press the (STOP) button on the remote control to turn on the power.

### 3. Pre-rinse function(Wet wall) - on/off setting instructions:

The wall-moistening function refers to the fact that when someone sits on the toilet seat, the toilet will automatically flush a small amount of water once to pre-moisten the inner wall of the toilet and prevent feces from sticking to it On the toilet. This function is turned off by default at the factory. If you want to use this function, you can do it like this Press and hold the (WATER TEMP) button on the remote control and hear one sound (DI)→off, and hear two sounds (DI, DI)→on.

### 4. Automatically flush after leaving the toilet seat - on/off setting instructions:

When you sit on the toilet seat, after using it, you will automatically flush after leaving the toilet seat. If this function is not required, please follow the following steps: Press the (FLUSH) button on the remote control for 3 seconds, hear one sound (DI) → turn off, and hear two sounds (DI, DI) → turn on.

## Remote control operation steps and function guide

Note: Please read the following carefully before use

### Remote control code matching:

First, press the switch on the plug to turn off the power, then press the switch on the plug to turn on the power, and after the toilet is fully turned on, rotate counterclockwise (knob) within 30 seconds. After hearing a long sound (DI), press any button on the remote control. After hearing a long sound (DI) again, it means that the remote control code is successfully matched.

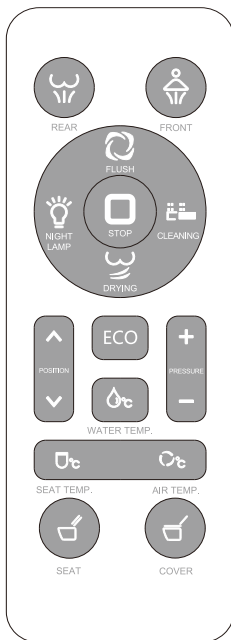

### REAR

This function requires you to sit on the toilet seat, press the (REAR) button, the (Cleaning Nozzle) will move out to clean the buttocks. Press the (REAR) button again, and the (Cleaning Nozzle) will start moving and cleaning, After 150 seconds, hip cleaning will automatically stop, or press the (STOP) button.

### FRONT

This function requires you to sit on the toilet seat, press the (FRONT) button, the (Cleaning Nozzle) will move out and start female cleaning. Press the (FRONT) button again, and the (Cleaning Nozzle) will start moving and cleaning, After 150 seconds, female cleaning will automatically stop, or press the (STOP) button.

### FLUSH

Press the (FLUSH) button to flush the toilet.

### NIGHT LAMP

Press the (NIGHT) button to turn on or off the night light.

### STOP

Press the (STOP) button to stop running functions such as buttock washing, female washing, and drying.

### CLEANING

Press the (CLEANING) button, (Cleaning Nozzle) will move out and water will come out for cleaning, and then you can use a brush or rag to clean (Cleaning Nozzle)

## DRYING

Warm air drying: This function requires you to sit on the toilet seat and press the (DRYING) button, the toilet will automatically flush once, and then start the warm air drying function. After 240 seconds, the warm air drying will automatically stop, or press the (STOP) button.

## POSITION

During the buttocks or female cleaning process, press this button to adjust the position of the (Cleaning Nozzle) forward. (repeatedly press the button to move the nozzle forward)

## POSITION

During the buttocks or female cleaning process, press this button to adjust the position of the (Cleaning Nozzle) backward. (repeatedly press the button to move the nozzle backward)

## ECO

When people are not seated, press the (ECO) button to turn off the ambient light and toilet seat temperature is constant at 82°F for energy saving.

The brightness of the ambient light can be adjusted to four levels (the lowest level turns off the ambient light). The operation is as follows: Press and hold the (STOP) button on the remote control to power off. Then press the (-) button on the remote control to adjust the brightness—each press changes the level. Then press the (STOP) button on the remote control again to power on.

## WATER TEMP

During the cleaning process of buttocks and female, press the (WATER TEMP) button to adjust the water temperature of (Cleaning Nozzle). There are 4 levels of water temperature adjustment, the first level is normal temperature, the second level is 93°F, the third level is 96°F, and the fourth level is 99°F.

## PRESSURE

During the cleaning process of buttocks or female, press the (+) button to increase the water pressure of (Cleaning Nozzle), and it can be adjusted to weak, medium, strong, and strongest.

## PRESSURE

During the cleaning process of buttocks or female, press the (-) button to reduce the water pressure of (Cleaning Nozzle), and it can be adjusted to and strongest, strong, medium, weak.

## SEAT TEMP

Press the (SEAT TEMP) button to adjust the toilet seat temperature, which can be adjusted in 4 levels. The first level is normal temperature, the second level is 93°F, the third level is 96°F, and the fourth level is 99°F.

## AIR TEMP

During the warm air drying process, press the (AIR TEMP) button to adjust the temperature of the (Dryer), which can be adjusted in 4 levels. The first level is normal temperature, the second level is F1, the third level is F2, and the fourth level is F3.

## SEAT

Press the (SEAT) button and the toilet seat will automatically open. Press the (SEAT) button again and the toilet seat will automatically close.

## COVER

Press the (COVER) button and the toilet lid will automatically open. Press the (COVER) button again and the toilet lid will automatically close.

## Common fault diagnosis

Note: If similar fault is found, please read the following solution or contact after sales

Fault phenomenon	Fault analysis	Fault handling
Product unavailable	Check to see if the power/socket is loose	Please check the circuit
	Whether there is leakage (the display light of leakage protection plug is not on)	Remove the power plug from the socket and replug it later. Press the reset switch of the leakage protection plug. If the toilet still cannot be operated, please unplug the power plug and entrust the repair.
No water with spray	Check if water is cut off	Pending resumption of water supply
	Check that the angle valve is closed	Open the angle valve
	Check if the inlet filter is blocked	Clean or replace the filter
	Check the inlet pipe for bends	Exclude the intake bend
Cleaning insufficient rigidity	Check whether the cleaning pressure is at the lowest level	Refer to the instruction manual for regulating the water pressure
	Check if the inlet filter is blocked	Clean or replace the filter
Spray water disorderly	Abnormal operation	Unplug the plug for one minute and then switch it back on
water temperature is not enough	Check that the water temperature is set low	Adjust the water temperature according to the instructions
	Whether the hot and cold massage function is on	Turn off the hot and cold massage function according to the instructions
The washer often drips water	Solenoid valve failure	Please get professional maintenance technicians
Misoperation of remote control	Check the battery level of the remote control is it too low	Please replace the battery
Drying/seat temperature too low/no heating	Check whether the temperature is set at low or normal temperature	Adjust the temperature according to the instruction
	Whether to turn on the power saving function	Refer to the manual to choose to turn off the power saving function
Seat/ cover falling too fast	Failure of damping drop function	Please get professional maintenance technicians
The cleaning function cannot be used normally	Is there any other hard material holding it under the seat	Remove the hard objects
	Whether the body's sensing area is covered	Adjust the body sensing area of the seat cover
	Whether the power supply is restored during the power failure	Unplug the plug for one minute and then switch it back on
	The skin completely cover the human body induction area of the seat	Sensor failure, please get professional maintenance technicians
Seat/cover cannot be opened or closed * Only for automatic flip machines	Failure of automatic damping function	1. Disconnect the plug for one minute and switch it back on 2. The above treatment is invalid, please ask professional personnel for maintenance
Low water pressure does not flush clean	Filter mist blocking	Clean the filter according to the instruction
	Pipe bending	Observe whether the connection line bends and keep the water supply line smooth
No siphon flushing is not clean when water pressure is normal	Air escapes from the sewage outlet	Please get professional maintenance technicians
	The S-bend is blocked	Please buy water pipe dredger in the market for dredging
Flush is not clean when water pressure normal	Flush valve failure	Ask professionals for maintenance

Due to the different printing time of the materials. the product specifications may be slightly changed. Please refer to the material object.

## Installation steps for smart toilet

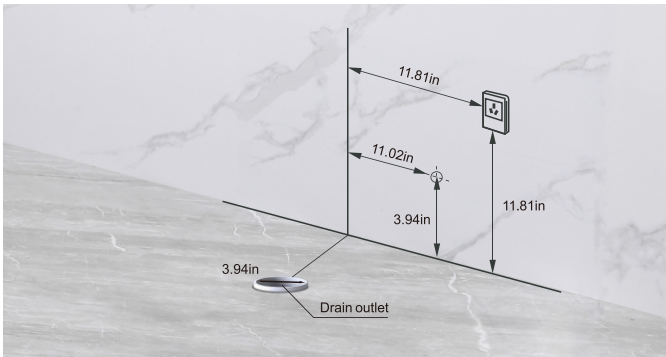

The confirmation of the installation environment.



1. The confirmation of the installation environment: The measurement distance is 11.81in or greater.



2. Place the fixed disk into the drain outlet and mark the screw hole positions.



3. Take off the fixed disk and drill four holes for screws.



4. Put the screws into the holes.

Corresponding to the following accessories/quantities:



5. Place the fixed disk into the drain outlet and tighten the screws to secure it.

Corresponding to the following accessories/quantities:





6. Install two long screws as I shown in the picture below.

Corresponding to the following accessories/quantities:

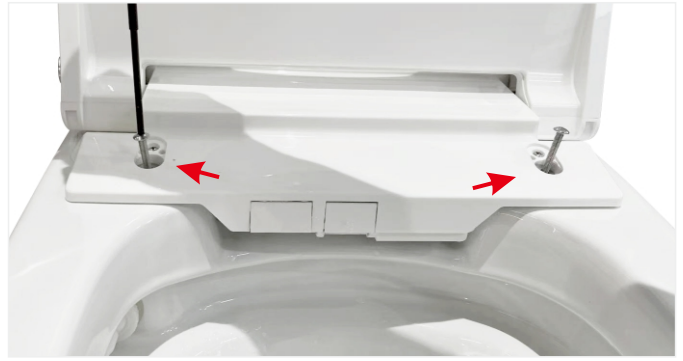

7. Remove the two white covers and then remove the two screws.

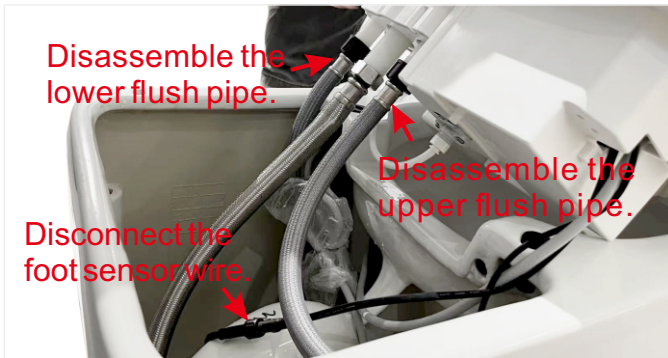

Disassemble the lower flush pipe.

Disassemble the upper flush pipe.

Disconnect the foot sensor wire.



8. Disassemble the lower flush pipe. Disassemble the upper flush pipe. Disconnect the foot sensor wire.

9. Remove the entire toilet seat cover.



10. Gently turn the toilet over to access the base and install the flange ring.



11. Apply a layer of silicone sealant to the base of the toilet. ( The glass adhesive in the picture needs to be purchased by oneself. )



12. Move the toilet to the location where it will be installed.

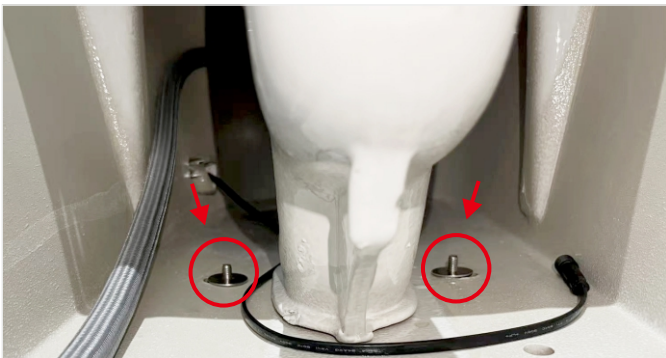
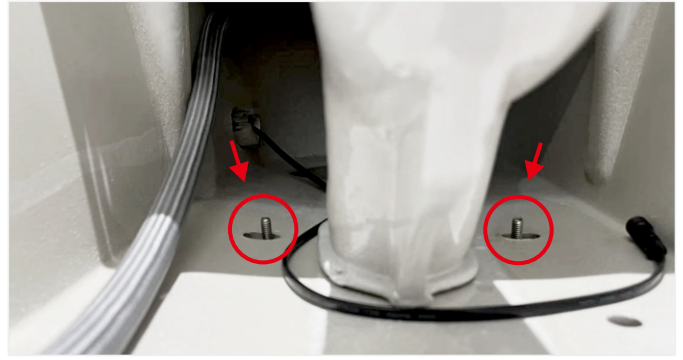

13. Install the gasket.

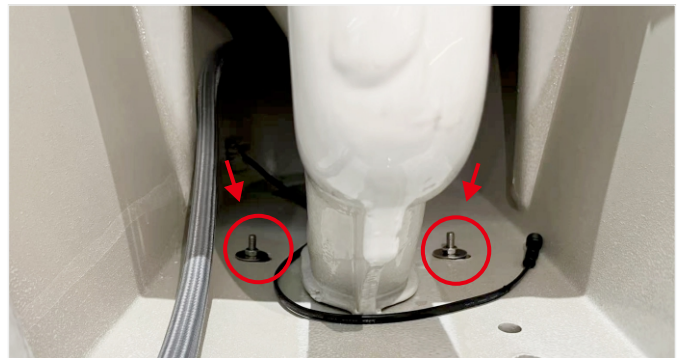

14. Tighten the nut.

Corresponding to the following accessories/quantities:



Corresponding to the following accessories/quantities:

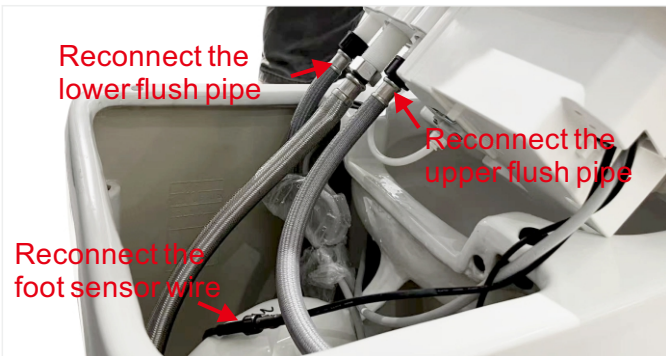

15. Reconnect the lower flush pipe.  
Reconnect the upper flush pipe.  
Reconnect the foot sensor wire.



16. Reinstall the two screws and the white covers.



17. Apply some glass glue to fix the toilet and insulate the outside dirt from entering. (The glass adhesive in the picture needs to be purchased by oneself.)

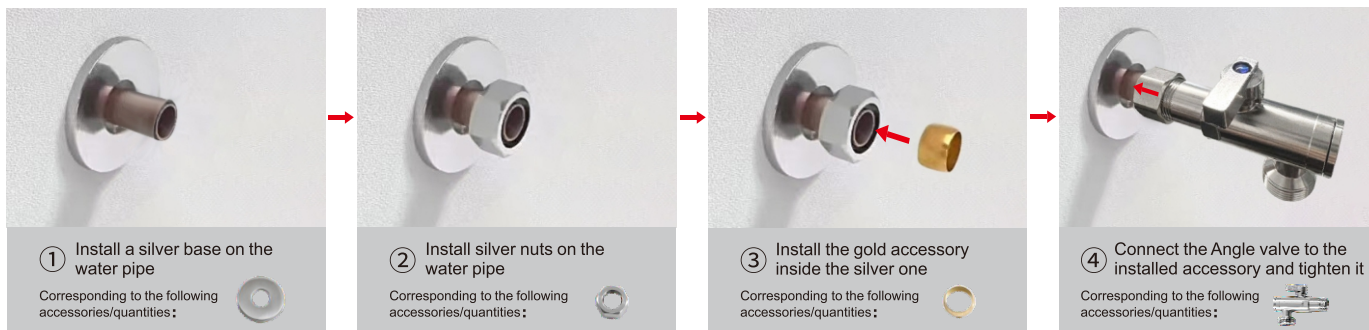

16. Finally connecting the flexible tube to the inlet angle valve and turn on the angle valve switch

**Attention: The above installation steps are universal for all models of toilets and are only for your reference during installation. If you find that the details in the pictures do not match the actual product, please ignore them!**

Our angle valve is a standard American-controlled angle valve. If the valve is incompatible with your plumbing setup, please contact us in time. email: [customerservice@hkfoam.com](mailto:customerservice@hkfoam.com), we will solve your problem as soon as possible.

## Battery replacement and installation

If in a power outage state, you can install a backup battery and the toilet can flush out of power. Note: If the backup battery is depleted, you can purchase a 9-volt battery and replace it by following the installation steps below.



Remove these two lids



Remove these two screws



Step 1. Cut off the power supply and lift the toilet cover

Step 2. Connect the backup battery's power cable to the power cable inside the toilet seat cover as shown in the figure, then push the seat cover back into place.

**Note:** When there is a power outage, please install the equipment battery for flushing. Press and hold the (Knob) on the left side of the toilet to activate flushing.

### Product standard

<b>Dimensions</b>	70*40*46.6CM		
<b>Rated voltage</b>	Alternating voltage 110V±10%, 60HZ		
<b>Rated power</b>	Water inlet temperature: 59°F      Outlet water temperature: 99°F Water discharge: 750ml/min      Average power: 1380W		
<b>Cleaning</b>	Water outlet	Hip cleaning	About 700 ml/min
		Female cleaning	About 700 ml/min
	Outlet water temperature		Normal temperature, and 93°F/96°F/99°F(4 grades)
	Water heating		Instant water heater
	Heater power		Water inlet temperature: 59°F , Outlet water temperature: 99°F Water discharge: 750ml/min      Average power: 1380W
<b>Seat heating</b>	Seat temperature		Normal temperature, and 93°F/96°F/99°F(4 grades)
	Heater power		45W
<b>Warm drying</b>	Wind temperature		Normal temperature, and F1/F2/F3(4 grades)
<b>Spray position</b>			Adjustable Fore and Aft
<b>Water temperature</b>			41~99°F
<b>Water Pressure ( Without Water Tank )</b>			Water pressure requirements: 0.15-0.75Mpa (static pressure), that is, filling 5L of water in 15 seconds means that the water pressure is sufficient.

**For any questions or support, please email: [customerservice@hkfoam.com]  
We're here for you: [customerservice@hkfoam.com]**

Due to the different printing time of the materials. the product specifications may be slightly changed. Please refer to the material object.