

THIS INSTRUCTION BOOKLET CONTAINS
IMPORTANT SAFETY INFORMATION. PLEASE
READ AND KEEP FOR FUTURE REFERENCE.

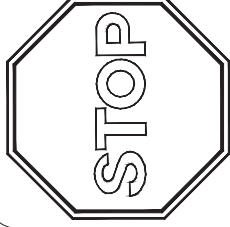

DO NOT RETURN PRODUCT TO THE STORE
Individual stores do not stock parts.

Lot Number: _____

Date Of Purchase: ____ / ____ / ____

If a part is missing or damaged, call our toll-free customer service line.
We will gladly ship your replacement parts FREE of charge.

Need Parts or Assistance?

1-800-489-3351

or access our website

www.ameriwood.com/parts

For prompt, reliable service please have your assembly manual ready.

Recommended # of people needed for assembly:2
(However it is always better to have an extra hand.)

Spanish translations are located in the center of this manual.

07312019MP

B347085335W00MP

Thank you for purchasing from AMERIWOOD.

Visit www.ameriwood.com to view the limited warranty valid in the U.S. and Canada.

BEFORE STARTING

- Read each step carefully before starting. It is very important that each step of instruction is performed in the correct order. If these steps are not followed in sequence, assembly difficulties will occur.
- Make sure all parts are included. Most board parts are labeled or stamped on the raw edge.
- Work in spacious area, preferably on a carpet, near the place the unit will be used.
- Have the following tools close at hand.
- Do not use power tools to assemble your furniture. Power tools may strip or damage the parts.

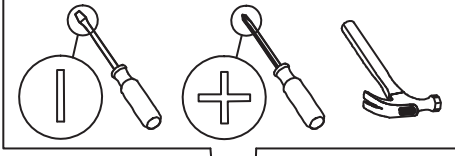

HELPFUL HINTS

- Visit our website for assembly video clips.
- Call our toll free number if you need assistance.
- Compression dowels are tapped in with a hammer.
- Back panels provide stability and support. Use all the nails provided. Units without the back panel installed may collapse.
- When tapping nails into a board, be sure there are equal margins on all side to square the unit.
- Move your new furniture carefully, with two people lift and carry the unit to it's new location.
- Never push, drag or scot your furniture (especially on carpet).
- Your ALTRAFURNITURE can be disassembled and reassembled to move.
- Additional parts are available for a nominal fee.

For help with assembly, identifying parts, product information or to order parts, please contact us:



Call us at: **1-800-489-3351**

Monday-Friday

9:00 am - 5:00 pm
(Central Time)



FAX:

1-636-745-1005

available 24 hours a day,
7 days a week



Visit our website:

www.ameriwood.com/parts



Write to:

AMERIWOOD INDUSTRIES
410 East 1st Street South
Wright City, MO 63390 USA
Attn: Service Dept.

PARTS

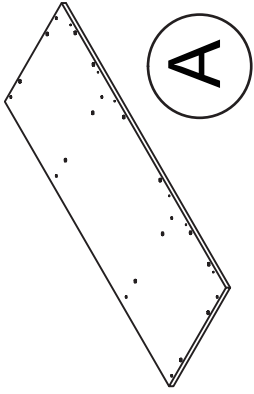

TOP
T7085335010MP

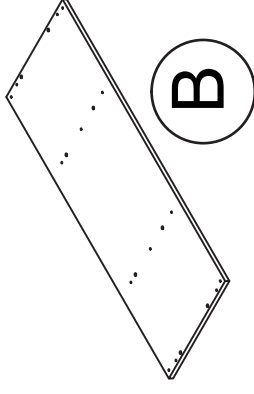

BOTTOM
T7085335020MP

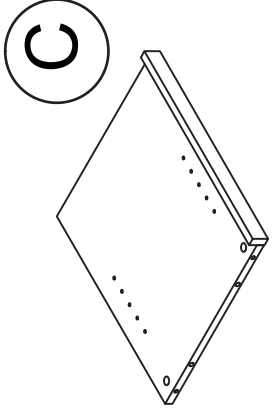

LEFT SIDE PANEL
T7085335030MP

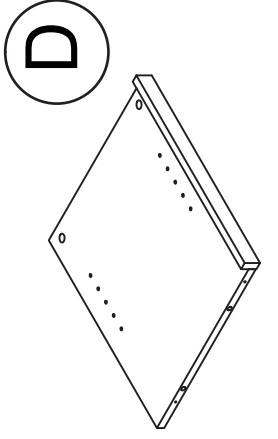

RIGHT SIDE PANEL
T7085335040MP

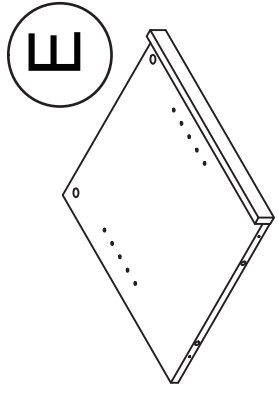

LEFT PARTITION
T7085335050MP

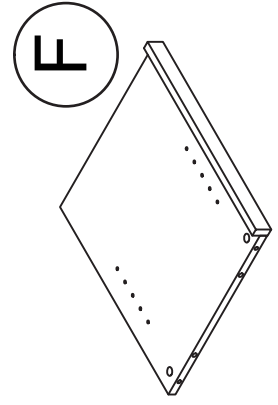

RIGHT PARTITION
T7085335060MP

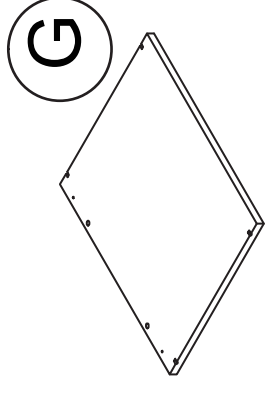

ADJUSTABLE SHELF
T7085335070MP

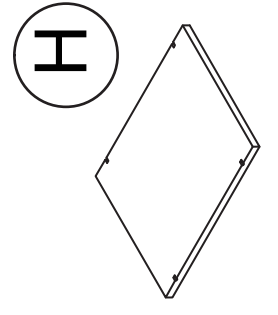

ADJUSTABLE SHELF
T7085335080MP

Qty: 2

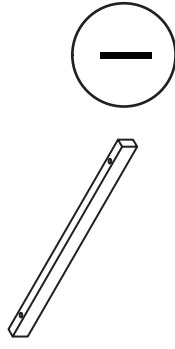

RAIL
T7085335090MP
Qty: 2

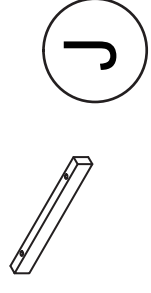

RAIL
T7085335100MP
Qty: 2

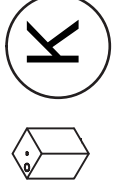

FOOT
T7085335110MP
Qty: 6

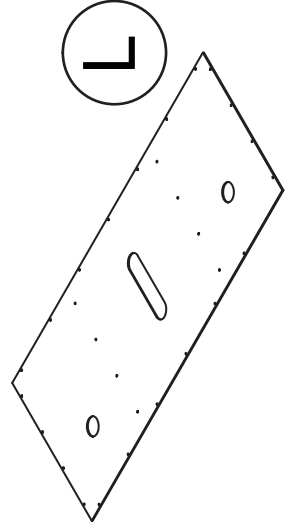

BACK PANEL
T7085335120MP

This illustration shows how the CAM fastening system works.

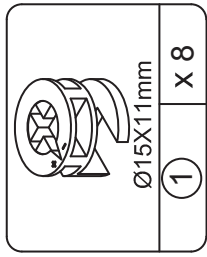

CAM LOCK
TMP5007
spare:1

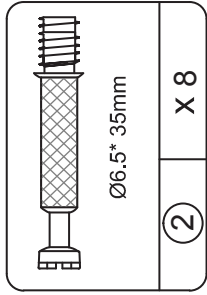

CAM BOLT
TMP5101
spare:1

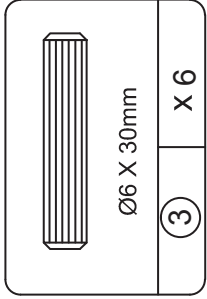

WOOD DOWEL
TMP8002
spare:1

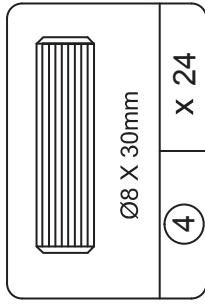

WOOD DOWEL
TMP8001
spare:1

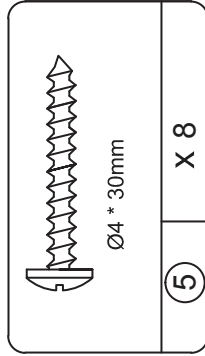

SCREW
TMP4502
spare:1

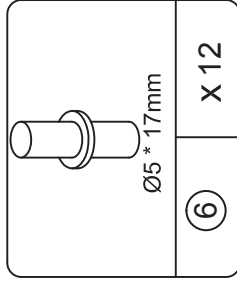

SHELF SUPPORT
TMP6005
spare : 1

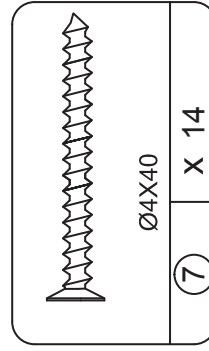

SCREW
TMP4205
spare:1

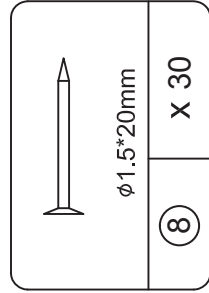

NAIL
TMP4703
spare:1

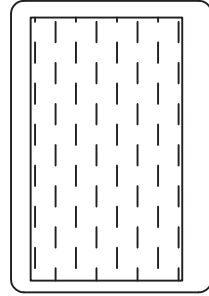

WARNING LABEL
TMP 7085

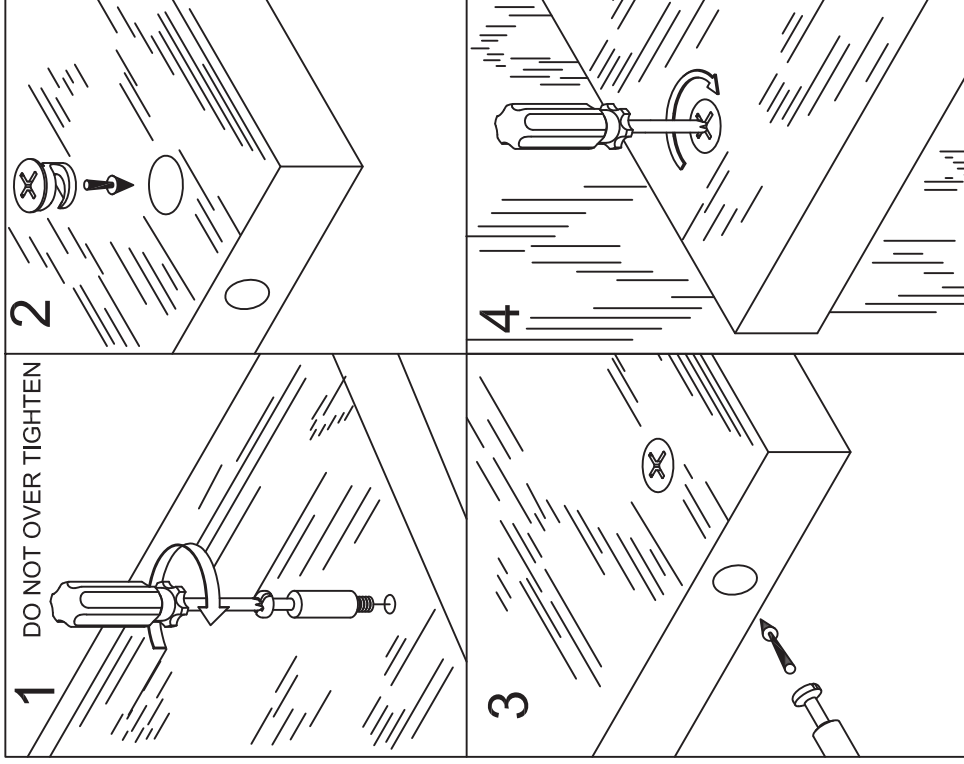

To view a video on how the CAM fastening system works, download a free QR-reader on your smartphone, then scan the code.

- 1**
- Insert wood dowels (4) into the holes of rails (I&J) as below shown.
 - Insert wood dowels (4) into the holes of panels (C&D&E&F) as below shown.
 - Put the cam locks (1) into the holes of panels (C&D&E&F) as below shown.

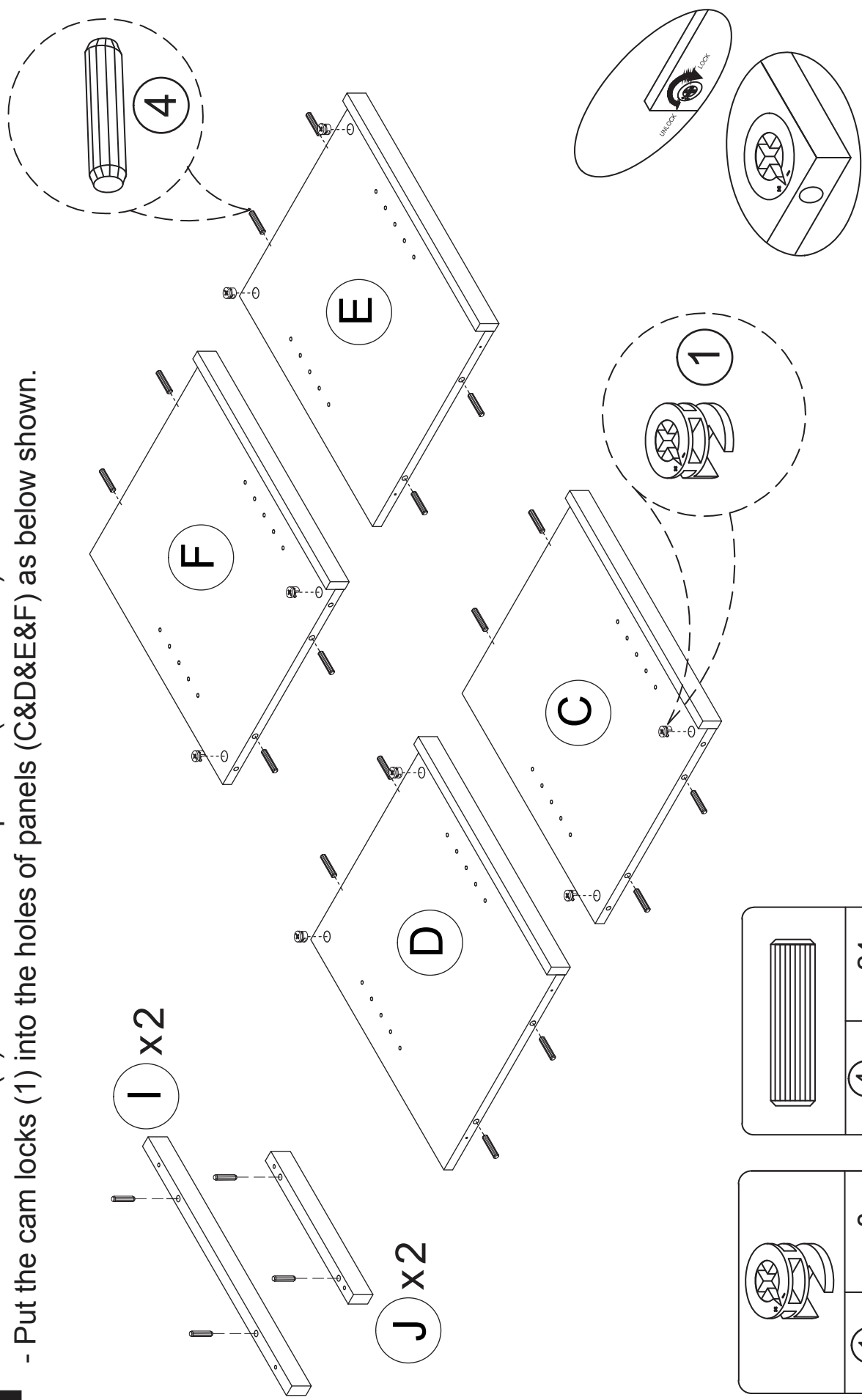

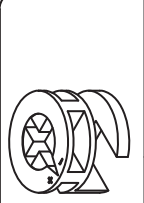
	(1)	x 8
---	-----	-----

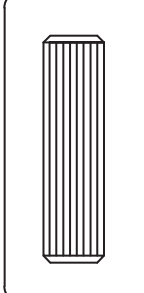
	(4)	x 24
---	-----	------

Proper orientation of CAM LOCK

2

- Screw cam bolts (2) into the holes of panels (A) as below shown.
- Attach rails (I&J) to the panel (A) with screw (5) as below shown.

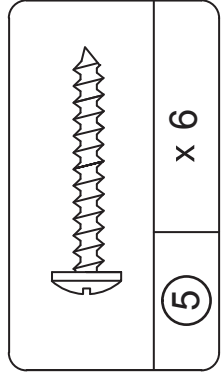
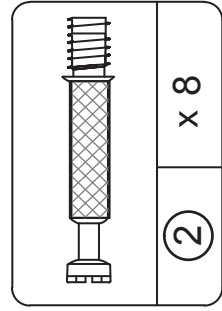
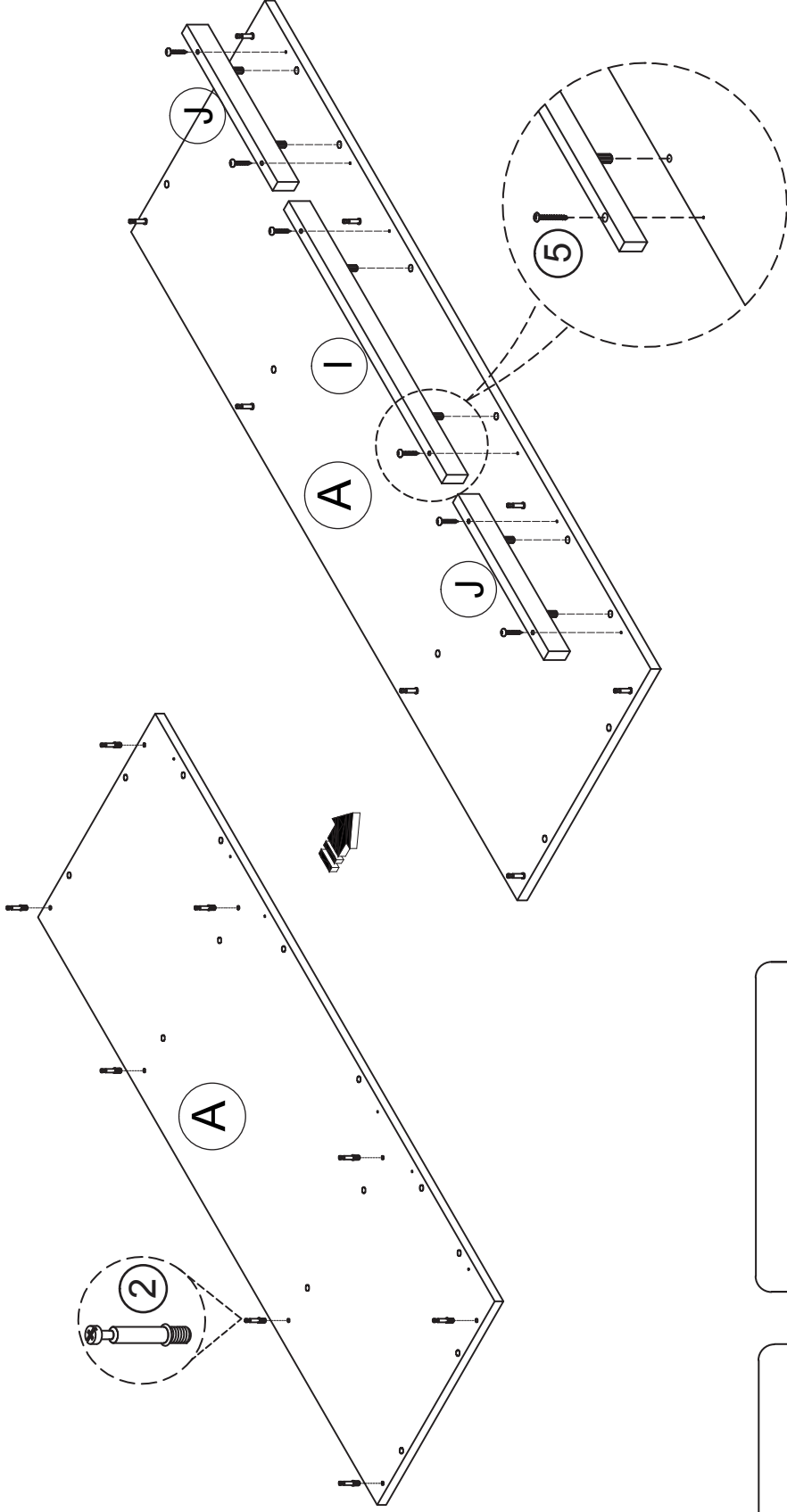

3

- Attach panels (C&D&E&F) into the top panel (A) as below shown.

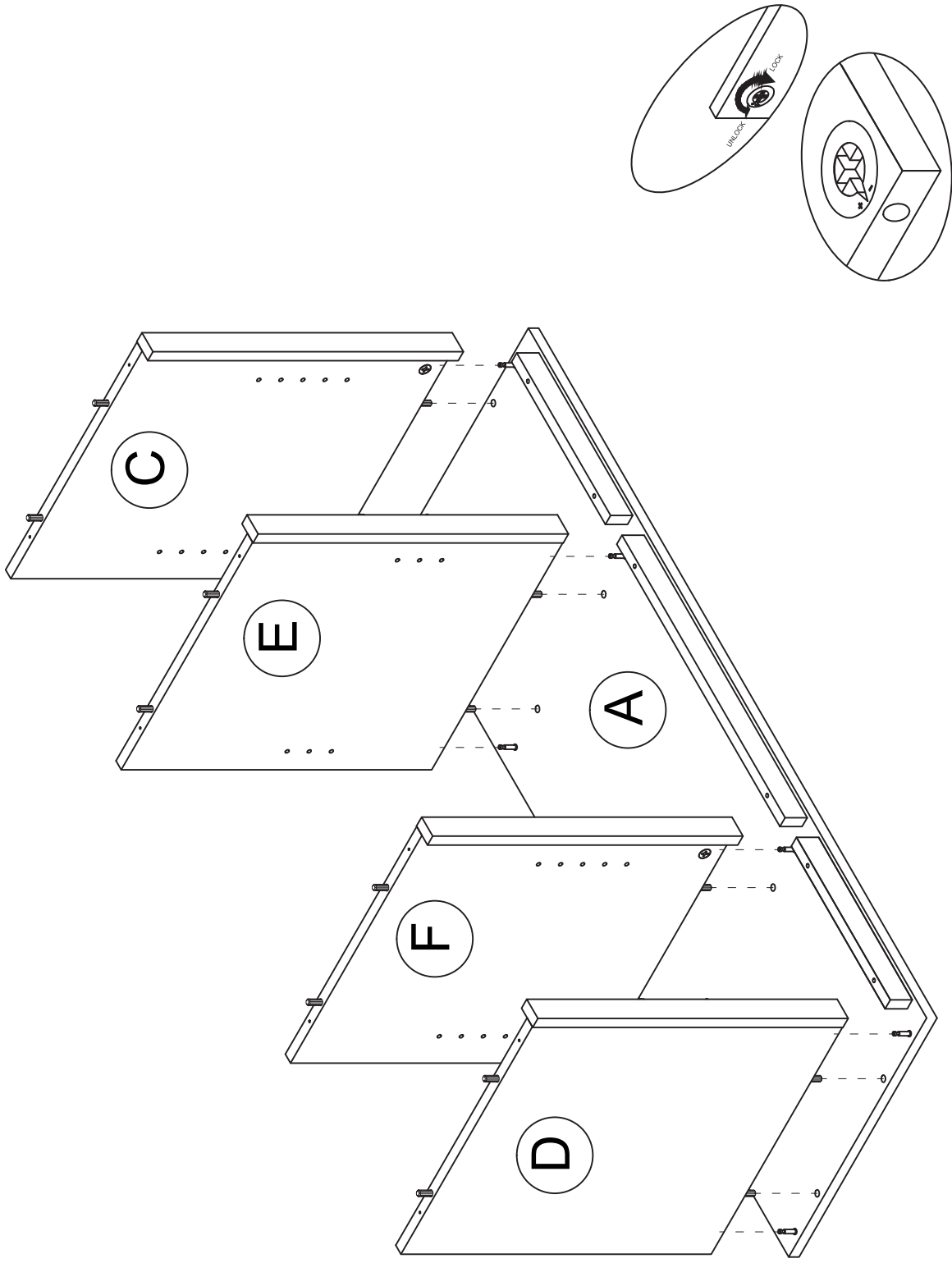

Proper orientation of CAM LOCK

4

- Insert wood dowels (3) into the holes of feet (K) as below shown.
- Attach feet (K) to assembled bottom panel (B) with screw (7) as below shown.

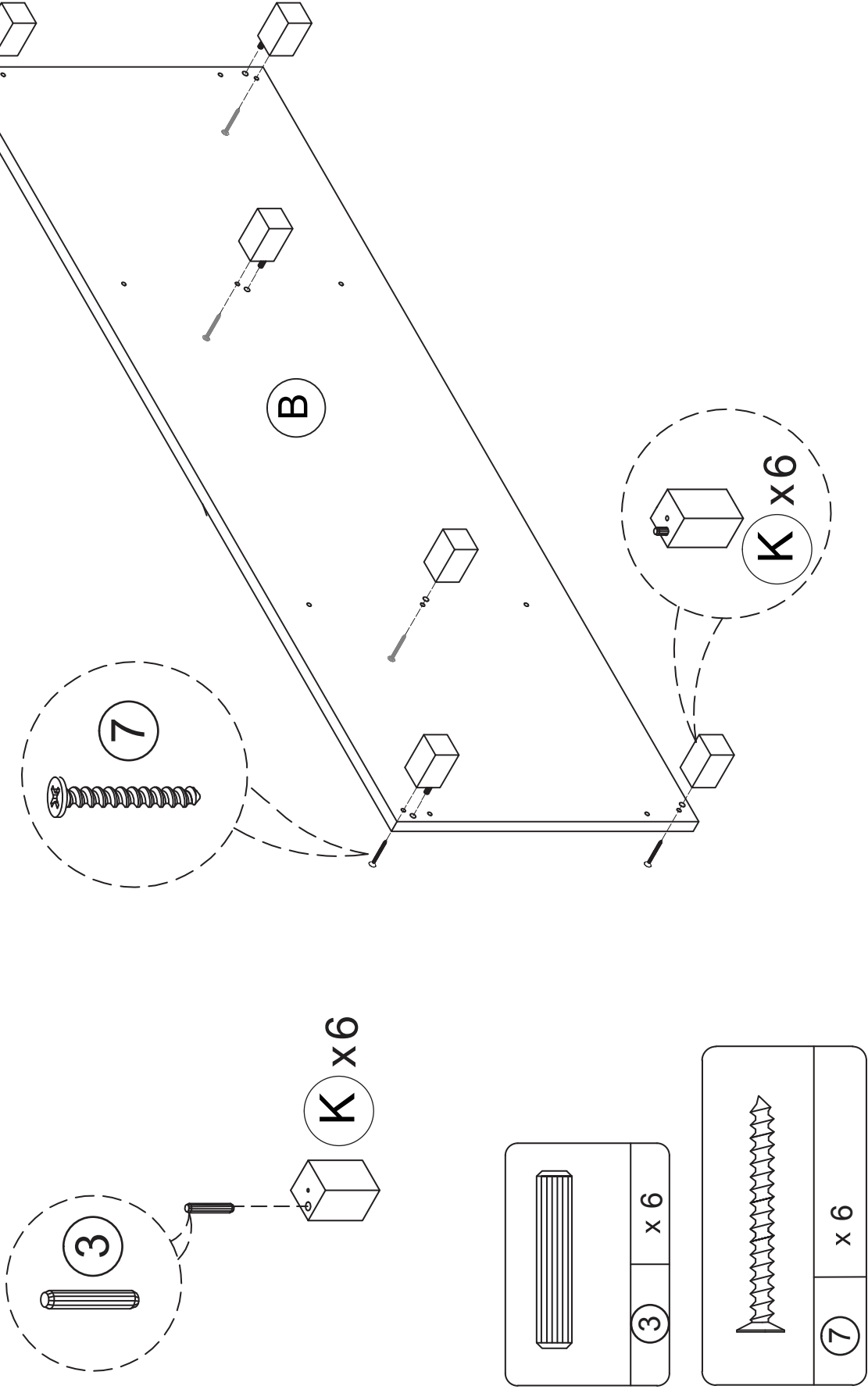

5

- Attach bottom panel (B) to assembled unit with screw (7) as below shown.

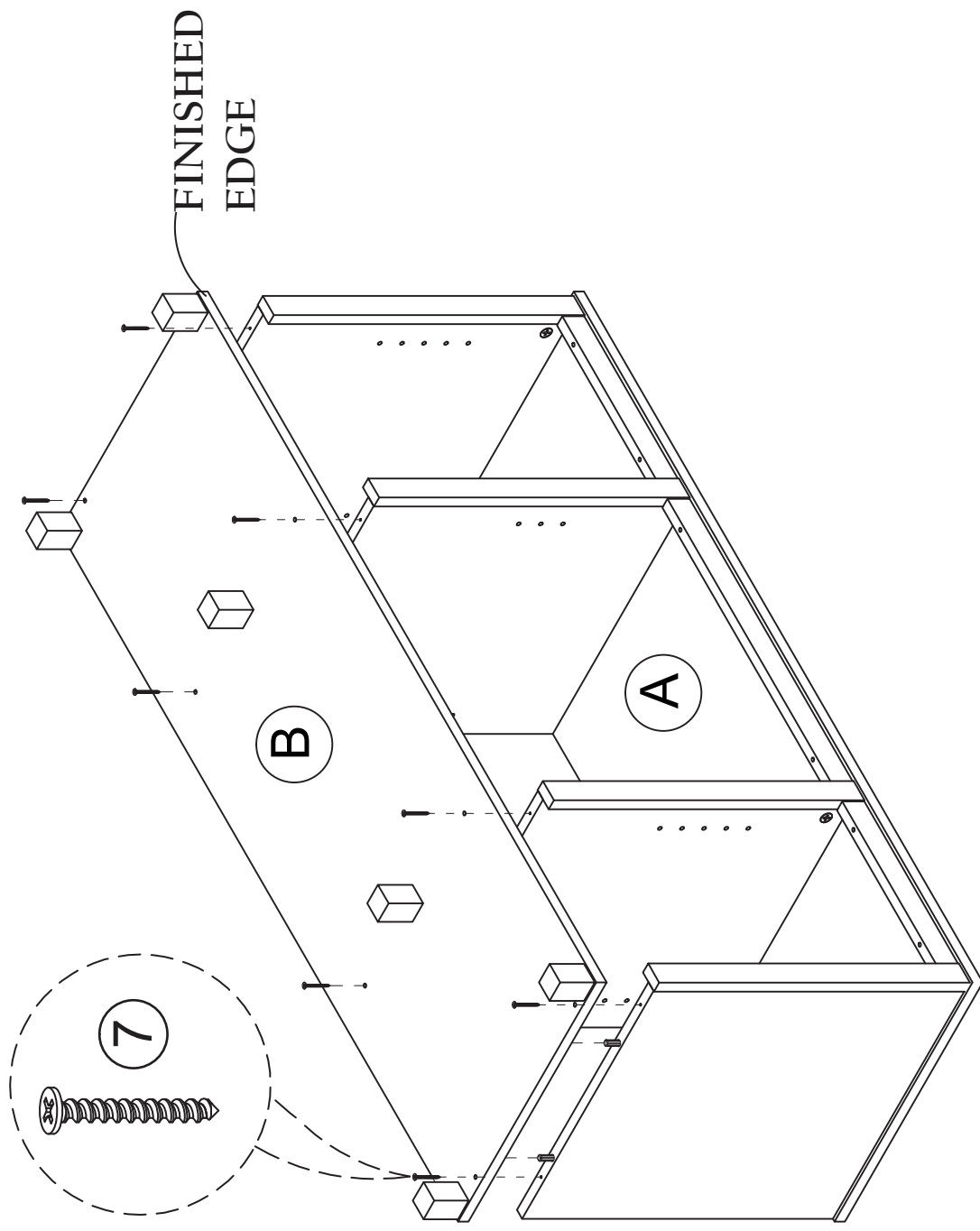

(7)	x 8

6

- Turn the unit as below shown.
- Attach back panel (L) to assembled unit with nails (8) as below shown.

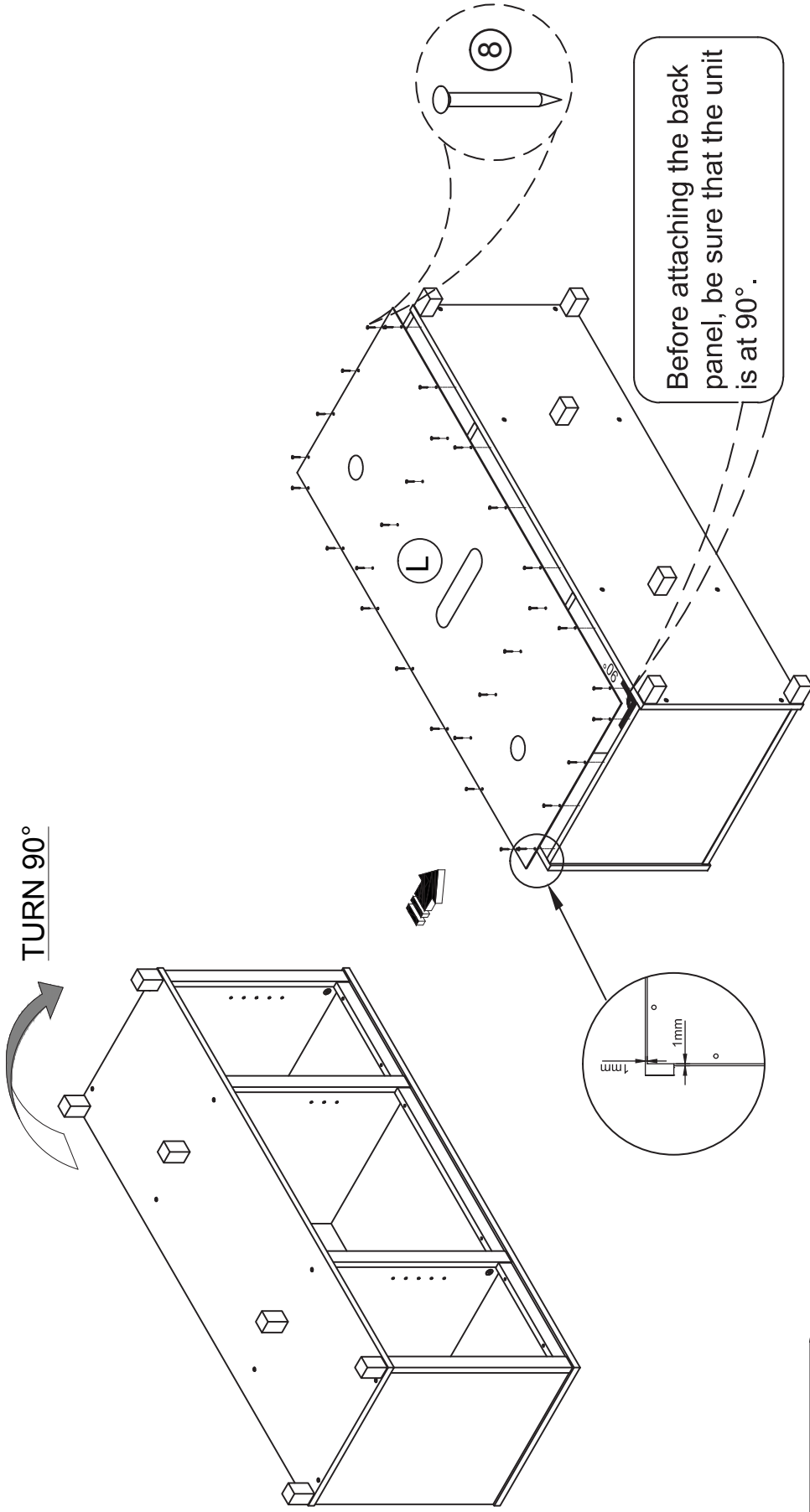

	
8	x 30

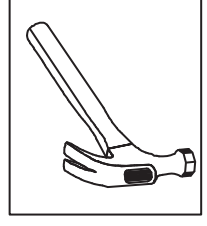

7

- Attach rail (I) to the panel (G) with screw (5) as below shown.
- Insert shelf support (6) into the holes of panels (C&D&E&F) as below shown.
- Put adjustment shelves (H&G) on shelf support (6) as below shown.

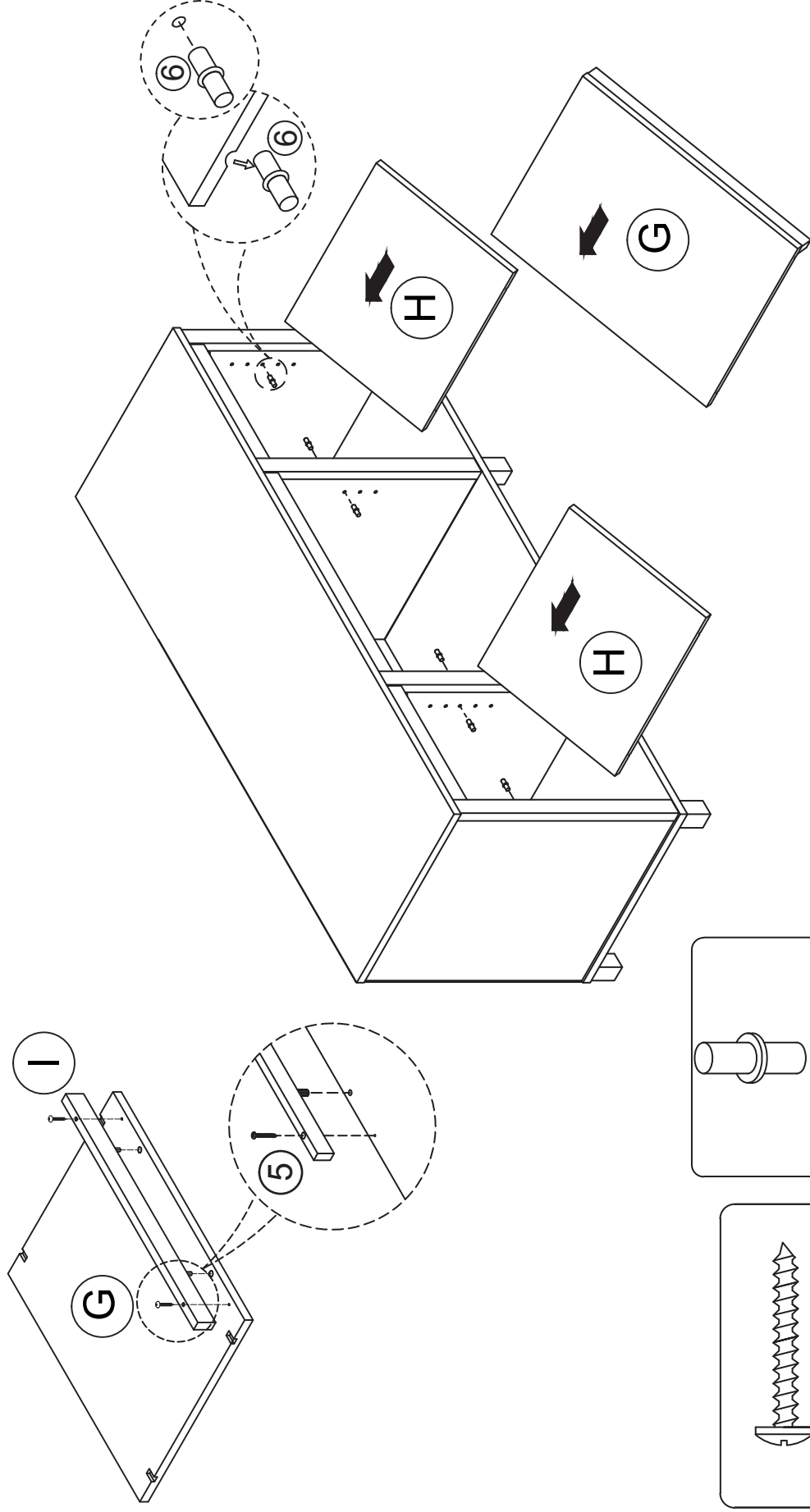

Call our toll free number for any assistance you should need or visit our website:

1-800-489-3351

www.ameriwood.com

WEIGHT LIMITS:

Clean the product with your favorite furniture polish and a soft cloth. Do not use harsh chemicals or abrasive cleaners.

Before moving the unit, remove everything including TV from the unit. Move your new furniture carefully with two people. Lift and carry the unit. Never push or drag the unit.

Do not allow children to climb or play on the unit. Failure to comply could result in severe injury.

This unit has been designed to support the maximum loads shown. Exceeding these load limits could cause unit sagging, instability, product collapse and/or serious injury.

Apply the warning label to the TV stand as shown, be sure the TV covers the label in use. You will not be able to remove the label after it is applied to the TV stand.

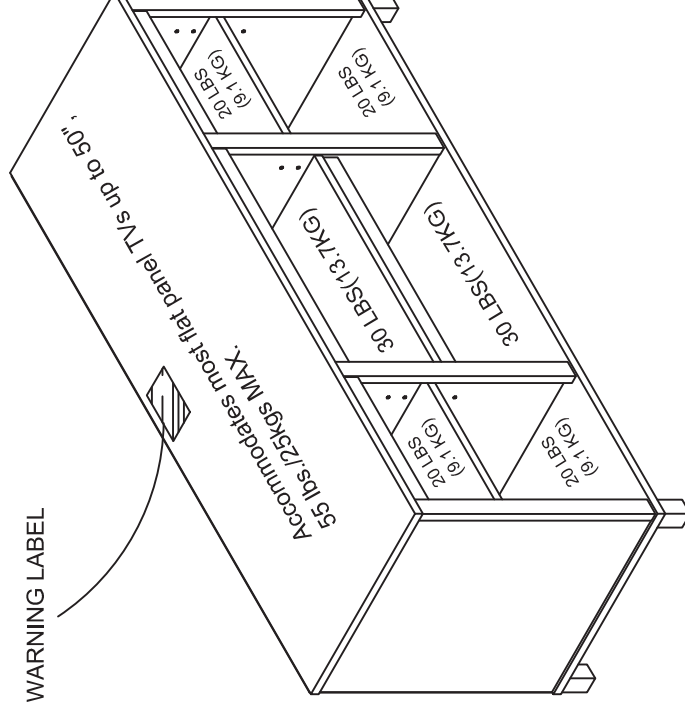

Enjoy Your Furniture

12/12