

RESIN OUTDOOR 6'x6' STORAGE SHED

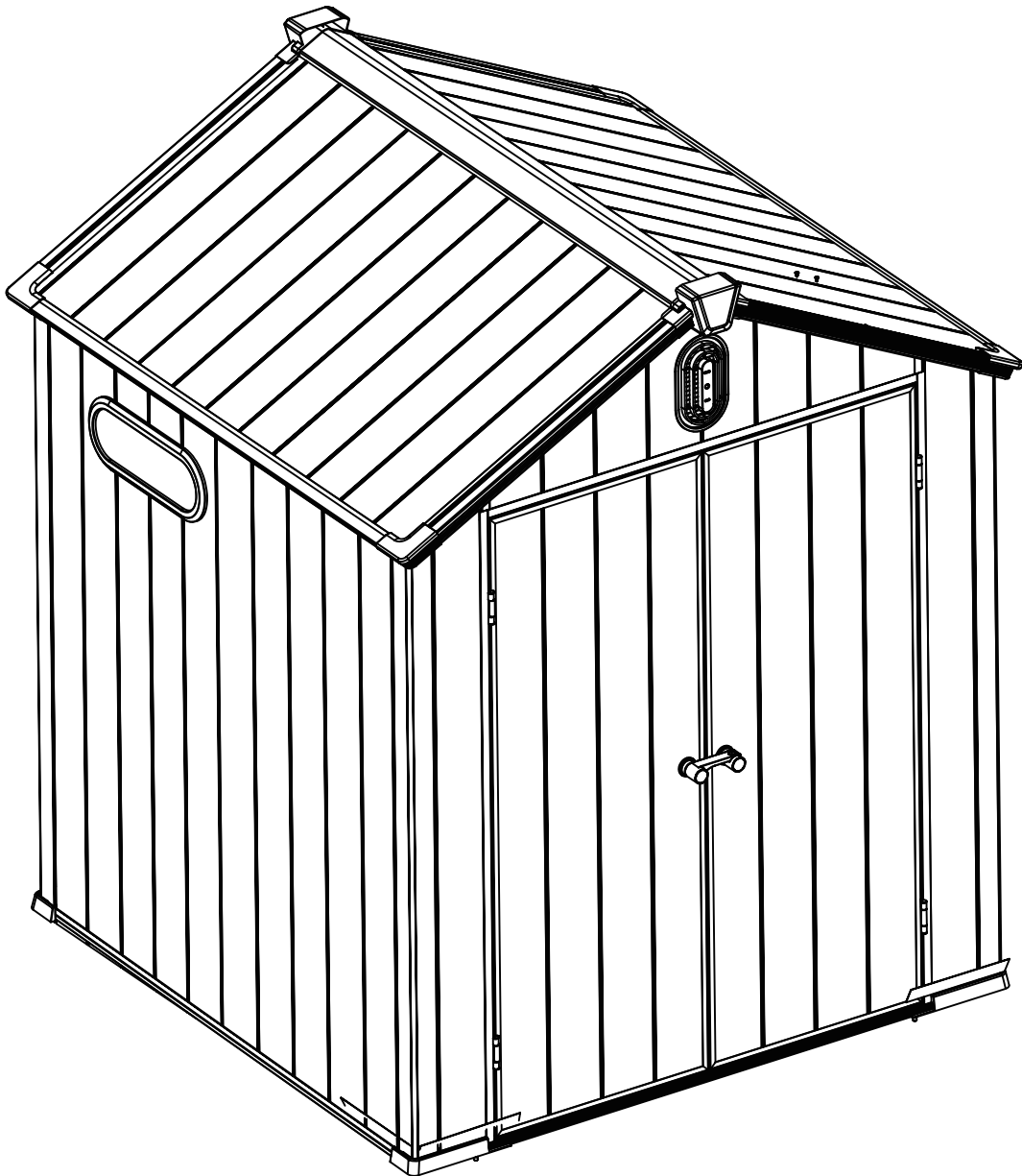

E-Mail: Patiofurniture Serviceteam@outlook.com
Please be careful of any sharp edges & corners.

NOTICE

PLEASE RETAIN THESE INSTRUCTIONS FOR FUTURE REFERENCE.

Dear Customer,

Thank you for shopping with us!

The shed is intended for storage purposes only. It is not designed for habitation:

A: It is strongly recommended to secure the shed to an immovable object or anchor to the ground by drilling holes in the shed floor (at the pre-marked locations) and inserting proper screws into the ground (screws are not included).

B: Do not attempt assembly on windy or cold days.

C: Periodically check the shed to ensure that it is stable and that the site is level.

D: Be careful when handling parts with steel edges.

E: When assembling or handling the shed, use only those tools listed in the user manual.

F: Always wear work gloves, safety goggles and long sleeves when assembling or performing any maintenance on your shed.

G: Avoid using a lawnmower or mechanical scythe near the shed.

H: Wear safety goggles and always follow the manufacturer's instructions when using power tools.

I: Wash the shed with a garden hose or a mild detergent solution. Do not use a metal brush or abrasive cleaners, including degreasers and oil- or acetone-based cleaning materials, as these may stain or damage the shed.

J: Do not store hot items, such as recently used grills and blowtorches, and volatile chemicals in the shed.

K: Avoid placing heavy items against the walls, as this may cause distortion.

L: Keep the roof clear of accumulated snow and leaves. Large amounts of snow on the roof can damage the shed, making it unsafe to enter.

M: Wind direction is an important factor to consider when determining the location of the shed. Reduce exposure to the wind, in general, and of the door side in particular. Keep doors closed and locked when the shed is not in use to prevent wind damage.

N: Do not stand on the roof.

O: Consult your local authorities to check if permits are required to erect the shed.

NOTICE

1. Site preparation

Leveling the ground.



2. Set up the base

It is recommended to build a wooden base or concrete base.

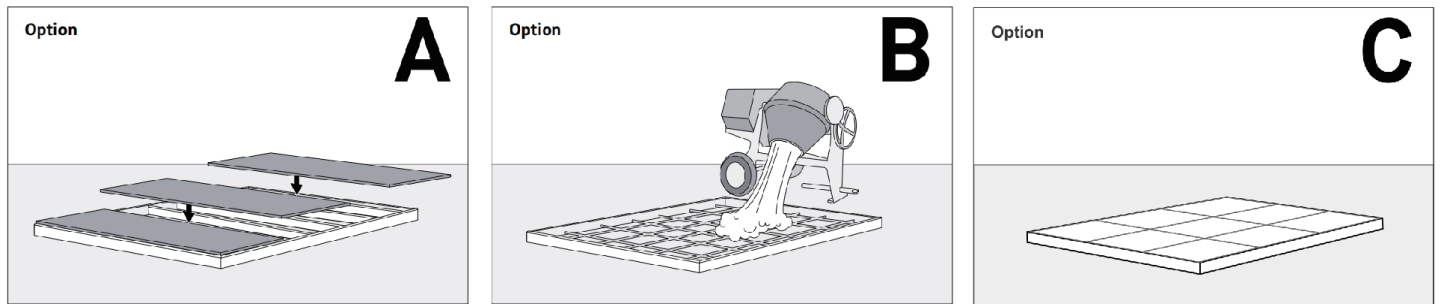

3. Leave enough space

Operating space shall be reserved for external installation work.

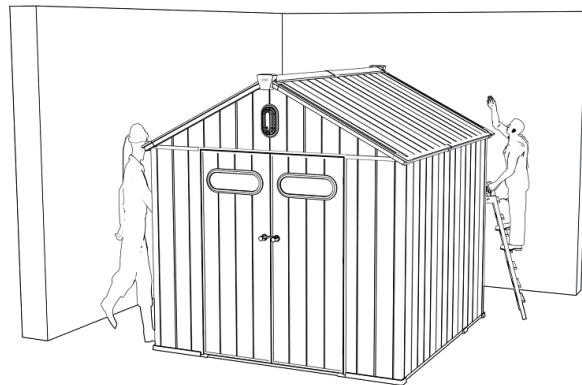

4. Parts are placed after unpacking

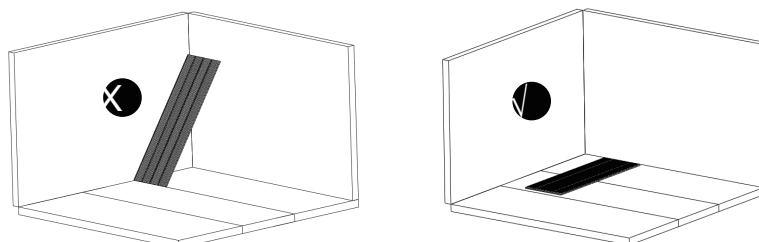

PART LIST

1. Please ensure that all accessories are complete before starting the installation.
2. Due to the variety of accessories, many accessories may be glued together, please check carefully
3. If any accessories are missing or damaged, please contact the seller immediately.
E-Mail: Patiofurnituresterceteam@outlook.com

NOTE: The proportion of line drawings of manual parts is only for reference. In the right corner is cut-away view.

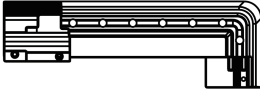
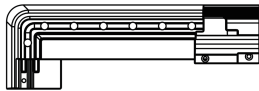
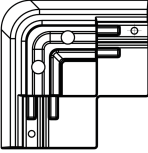
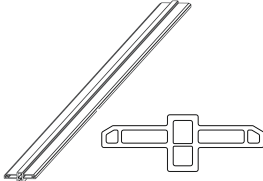
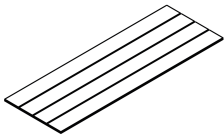
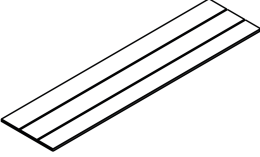
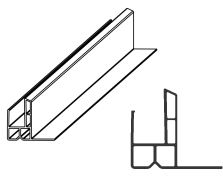
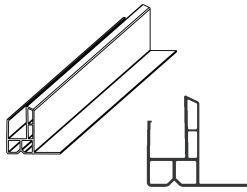
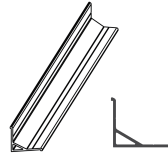
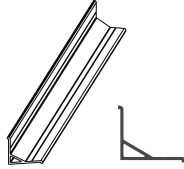
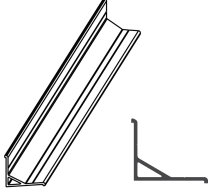
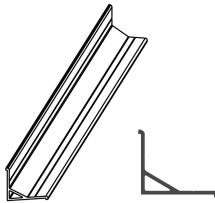
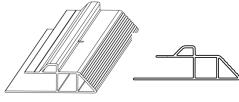
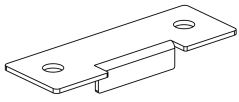
FLOOR PART COMPONENTS				
				
KCFFB.L6 X1	KCFFB.R6 X1	KCFRC X2	F.9(KC6) X2	F.8(KC6) X2
				
F.10(KC6) X1	F.3(KC46) X2	F.6(KC6) X1	F.14(KC46) X2	F.16(KC6) X1
				
F.12(KC6) X1	F.13(KC6) X1	F.1(KC) X1	F.19(kc) X1	

PART LIST

WALL PART COMPONENTS

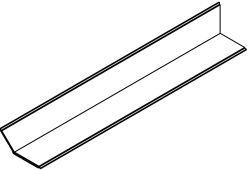
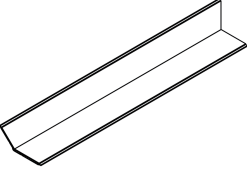
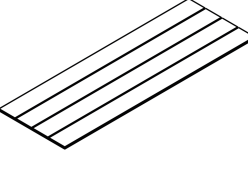
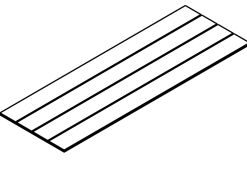
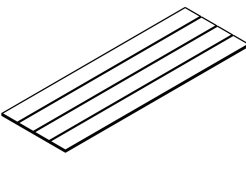
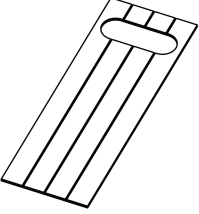
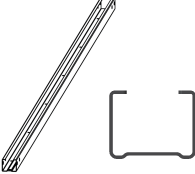
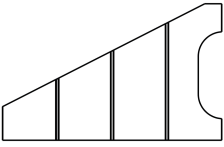
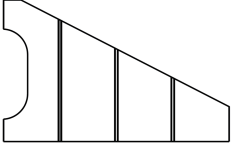
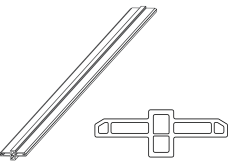
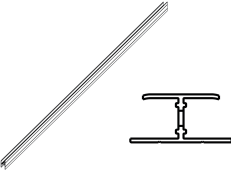
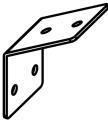
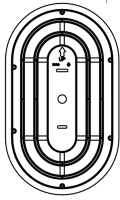
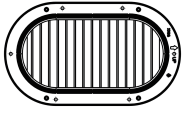
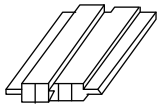
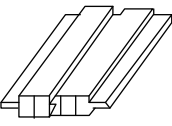
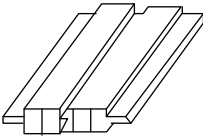
				
W.1(KC6) X2	W.6(KC6) X2	W.2(KC6) X2	W.2(KC) X2	W.4(KC6) X1
				
W.5(KC6) X1	FR.4(KC6) X2	W.12(KC6) X2	W.15(KC6) X2	W.3(KC6) X2
				
W.11(KC6) X1	HD.3(KC) X4	VNR2.OUT X2	VNR2.IN X2	W.7(KC6) X1
				
W.13(KC6) X2	W.14(KC6) X2			

PART LIST

ROOF PART COMPONENTS

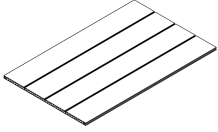
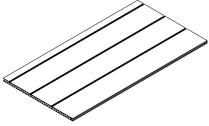
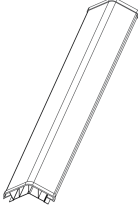
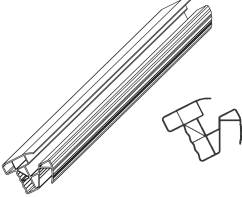
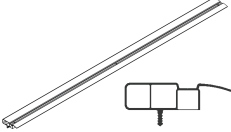
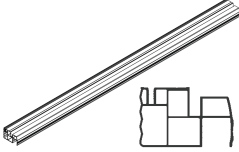
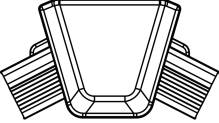
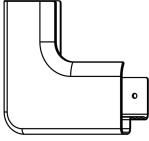
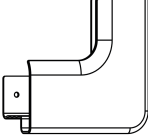
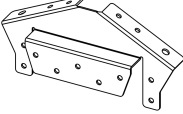
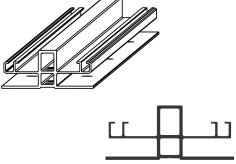
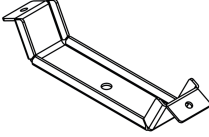
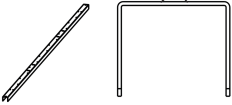
				
R.6(KC6) X4	R.4(KC6) X2	R.8(KC46) X1	R.2(KC46) X2	R.7(KC6) X4
				
R.1(KC6) X4	KRRH X2	KCRBC.L X2	KCRBC.R X2	FR.6(KC) X2
				
R.5(KC6) X4	HD.2(KC) X2	FR.7(kc46) X2		





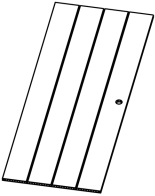
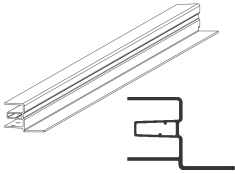
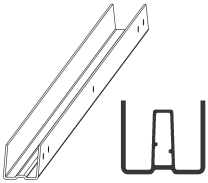
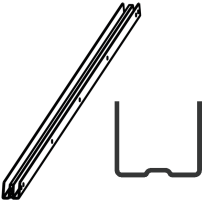
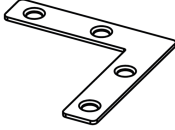
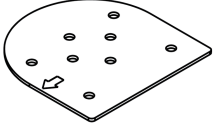
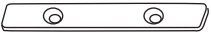
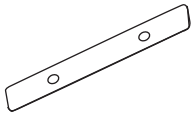
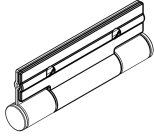
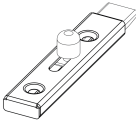
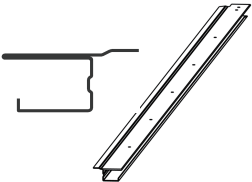
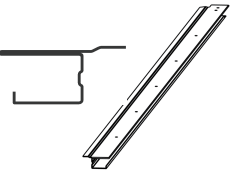
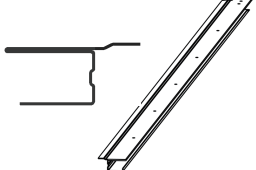
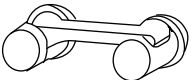

PART LIST

DOOR PART COMPONENTS

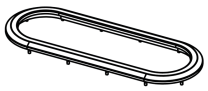
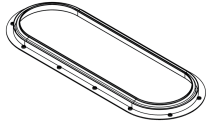
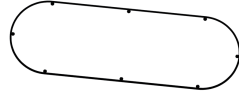

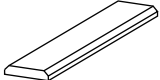

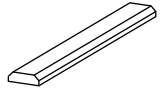
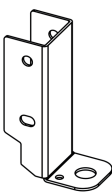
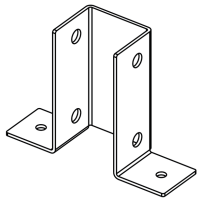
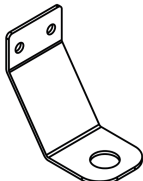
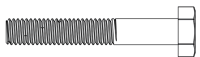

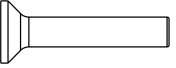
				
D.1(KC6) X2	D.2(KC) X1	D.3(KC) X3	D.4(KC) X4	HD.1(KC) X2
				
DH.5 X2	HD.9(kc) X1	HD.10(kc) X1	HD.7(KC) X4	HD.8(KC) X2
				
W.8(KC6) X1	W.9(KC6) X1	W.10(KC) X1	DH X1	

PART LIST

WINDOW PART COMPONENTS

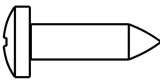
			 	 
WIR2.OUT X1	WIR2.IN X1	WIR2.PC X1	Flat Rubber sealing stripe x1 2mm*12mm	Flat Rubber sealing stripe x1 2mm*5mm
				
FR.14(KC) X1	FR.11(KC) X1	HD.6(KC) X4	FT.7(M6X40) X4	FT.7A(M6) X8
				
FT.8(M6X16) X4				

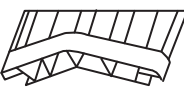
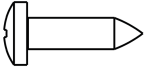
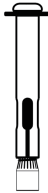
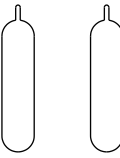
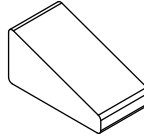
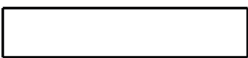
PART LIST

ACCESSORY				
				
FT.1(5X14) X150	FT.2(3.9X12) X125	FT.3(3.9X30) X46	FT.4(2.9X8) X8	FT.6(4X14) X60
				
Rubber sealing strip x2 2mm*20mm	FT.5(2.9X20) X12	FT.12(M8X80) X5	STICKER X2	PADS X2
				
Install the guide piece x2	FT.11 (M3x6) X2			

NOTE: The plastic pieces are guide pieces assisting inserting wall panels

ROOF

ROOF INSTALLATION

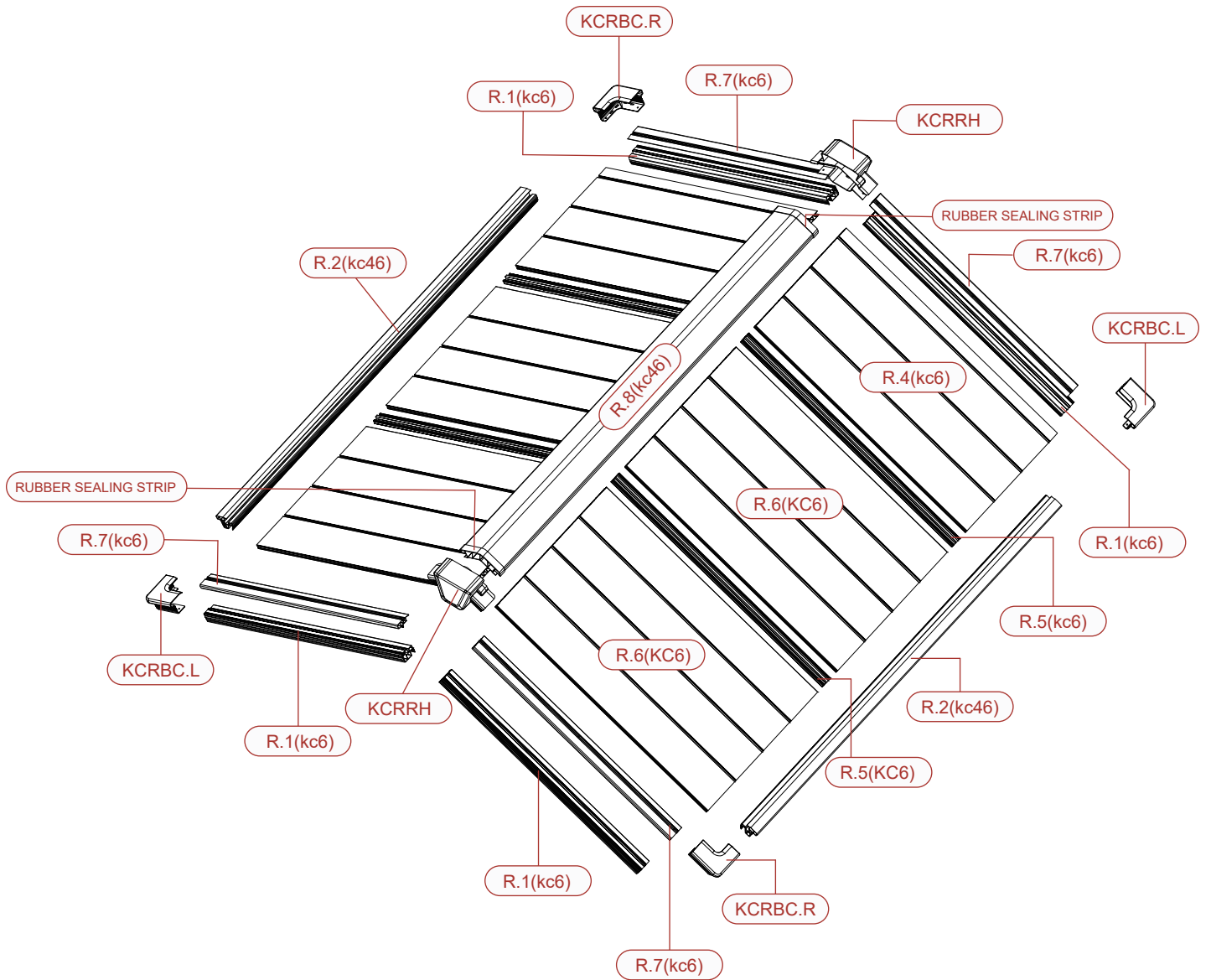

ROOF SUPPORT

ROOF SUPPORT INSTALLATION

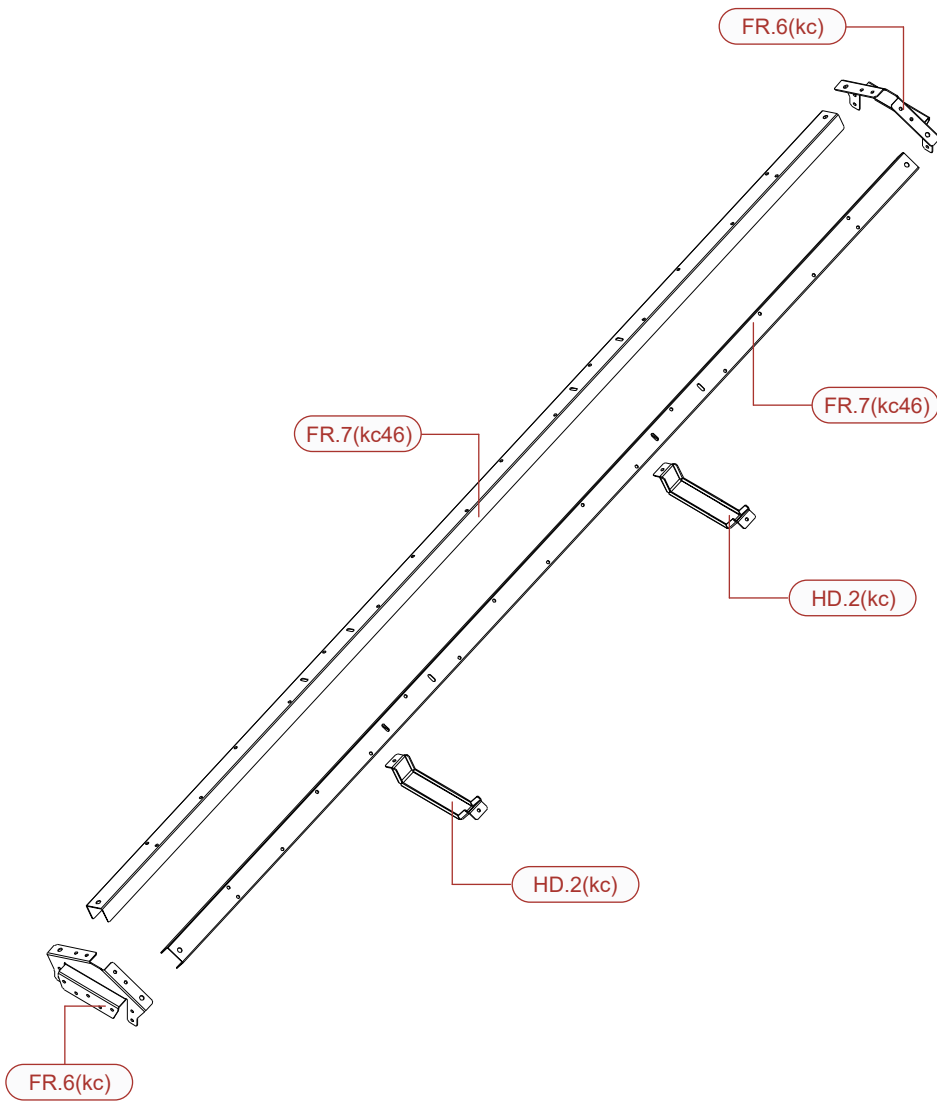

REAR WALL

REAR WALL INSTALLATION

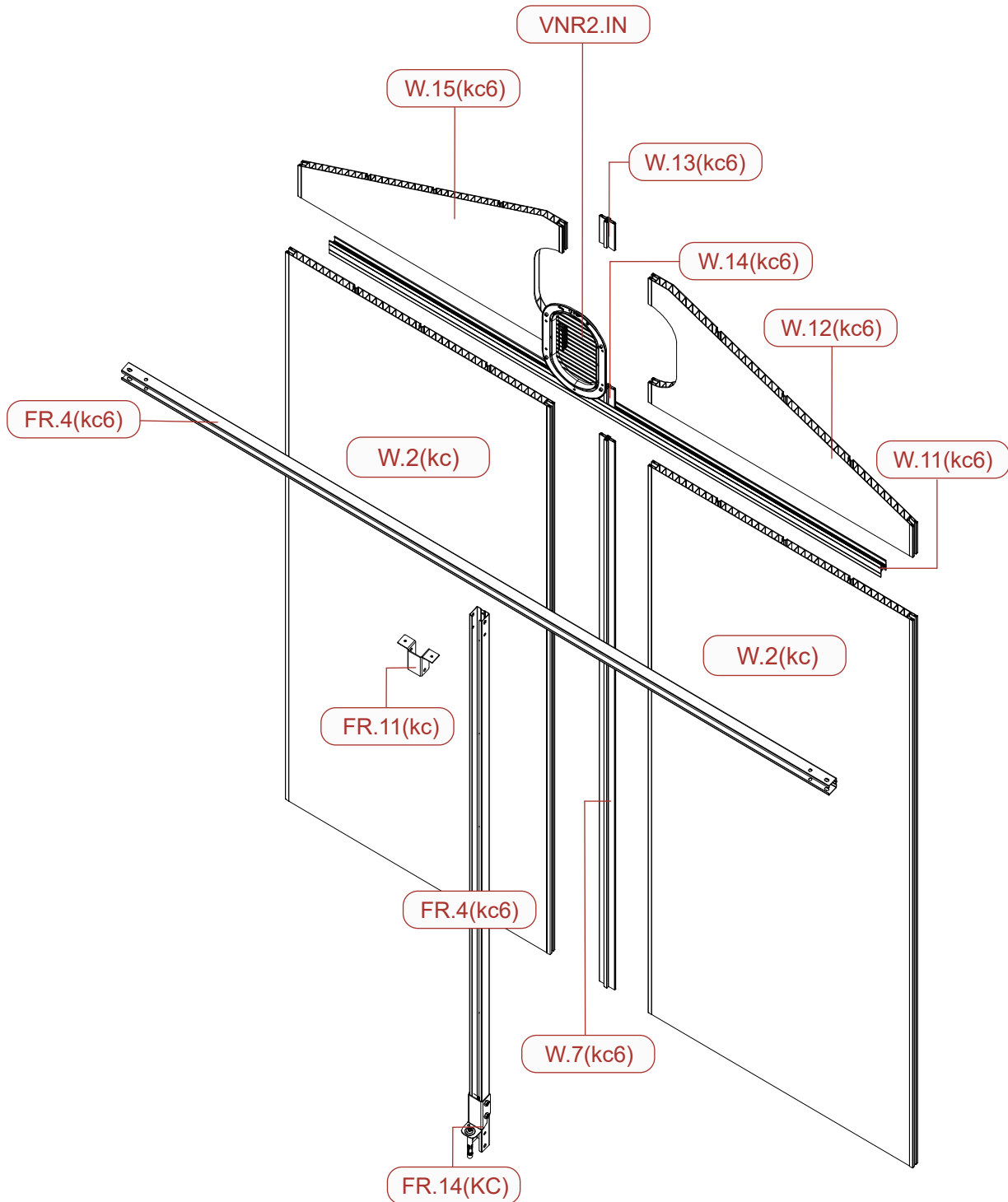

DOOR

DOOR INSTALLATION

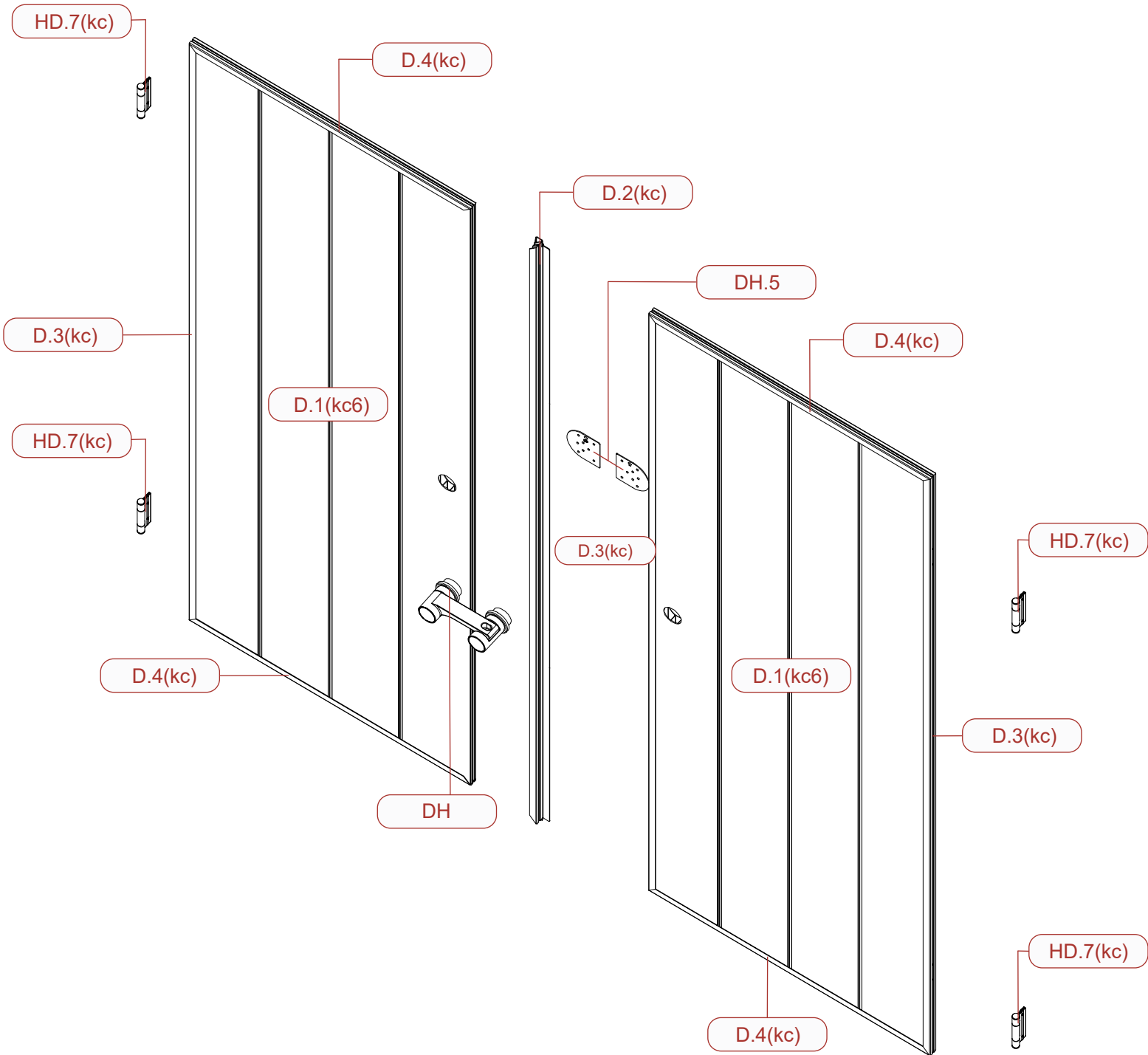

DOOR FRAME

DOOR FRAME INSTALLATION

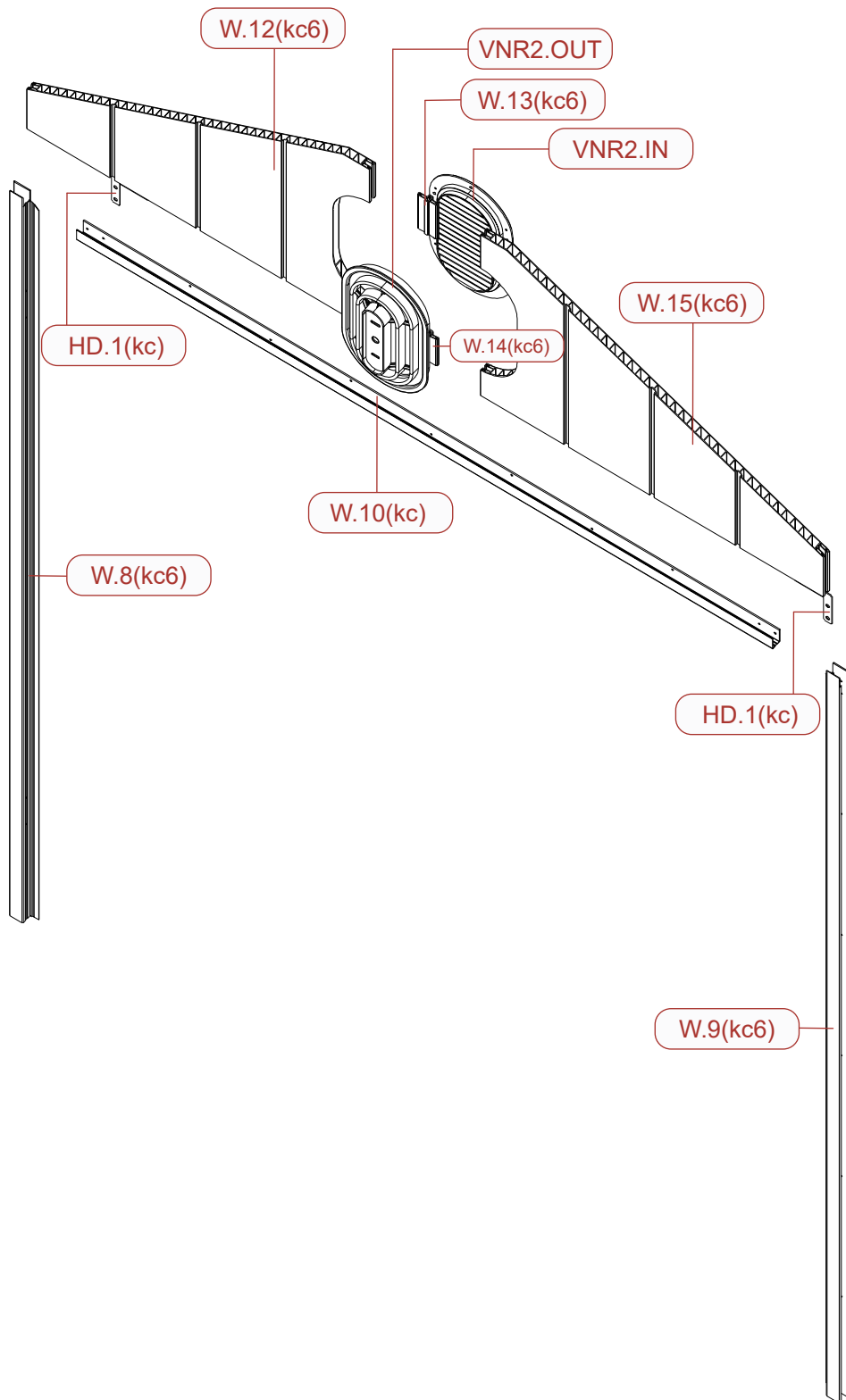

RIGHT WALL

RIGHT WALL INSTALLATION

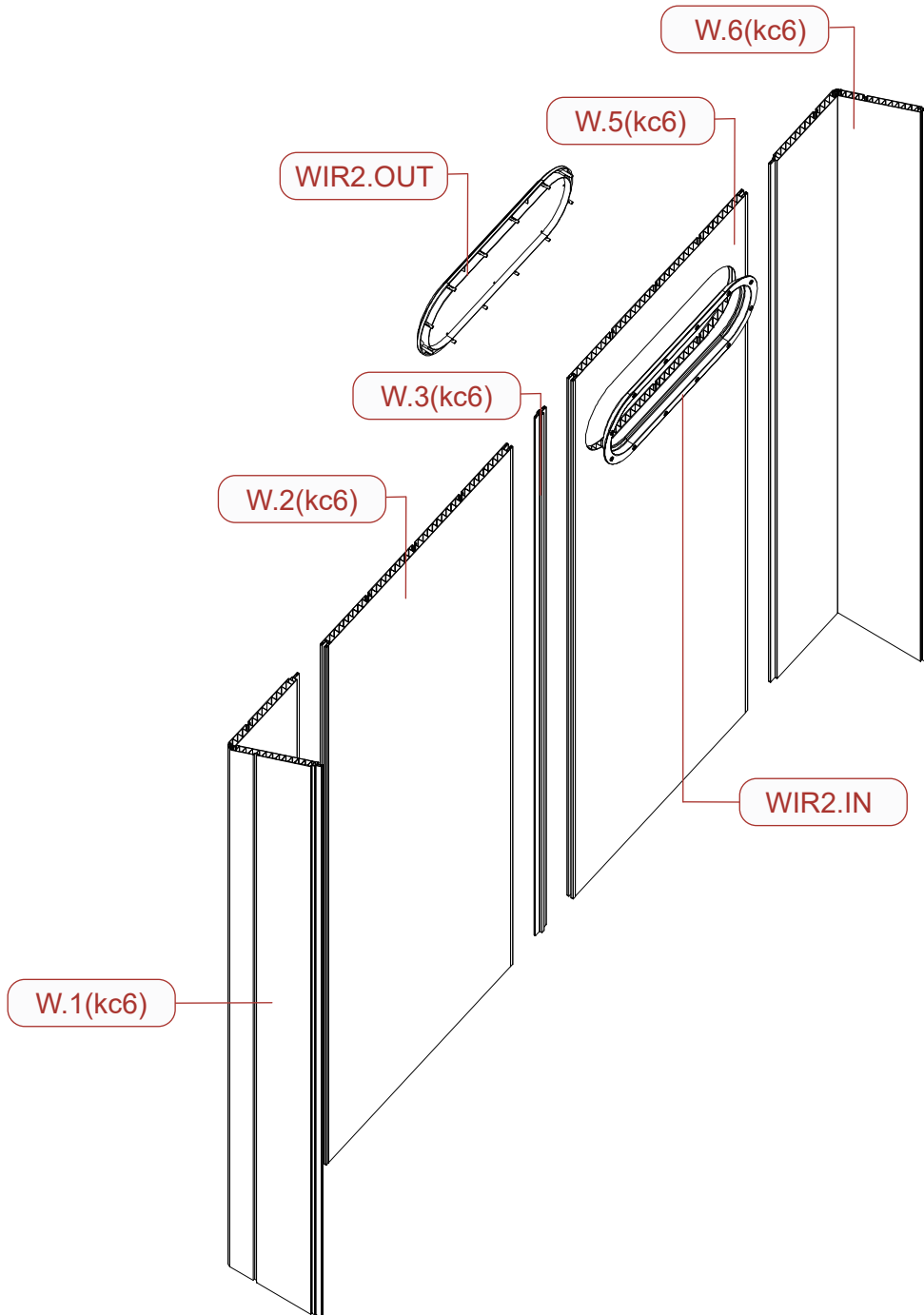

LEFT WALL

LEFT WALL INSTALLATION

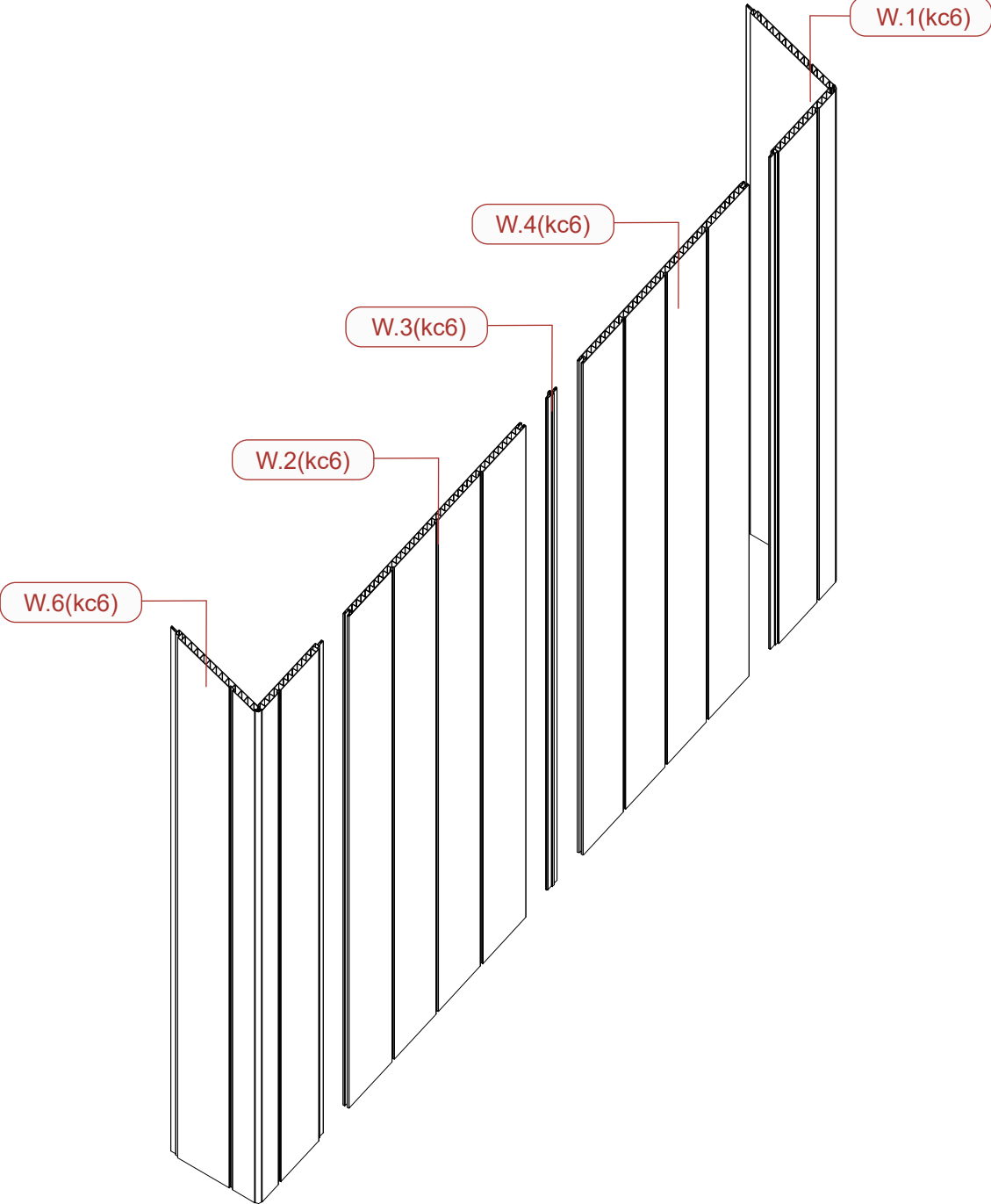





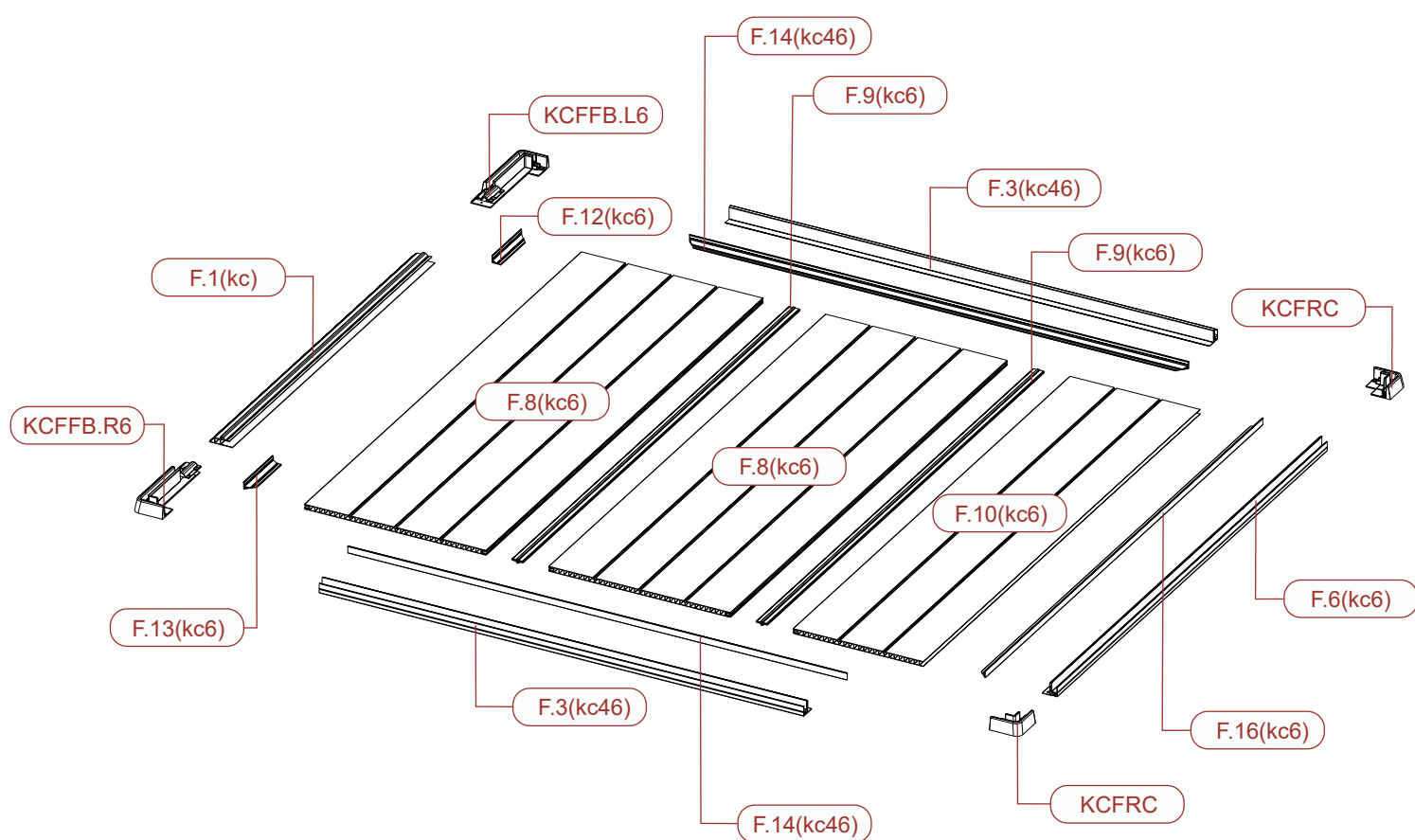

FLOOR

FLOOR INSTALLATION



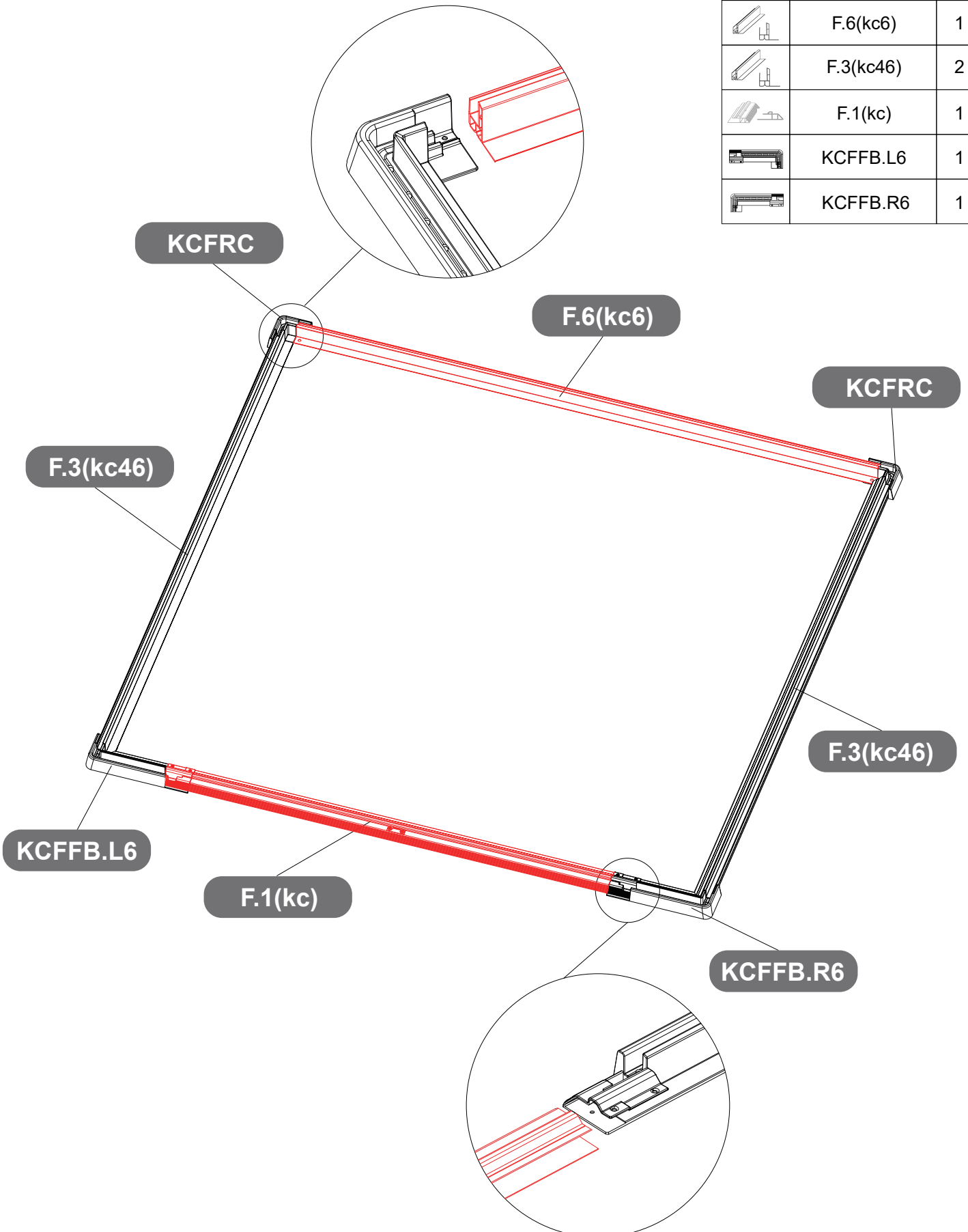

STEP 1

PART	NO	QTY
	KCFRC	2
	F.6(kc6)	1
	F.3(kc46)	2
	F.1(kc)	1
	KCFFB.L6	1
	KCFFB.R6	1





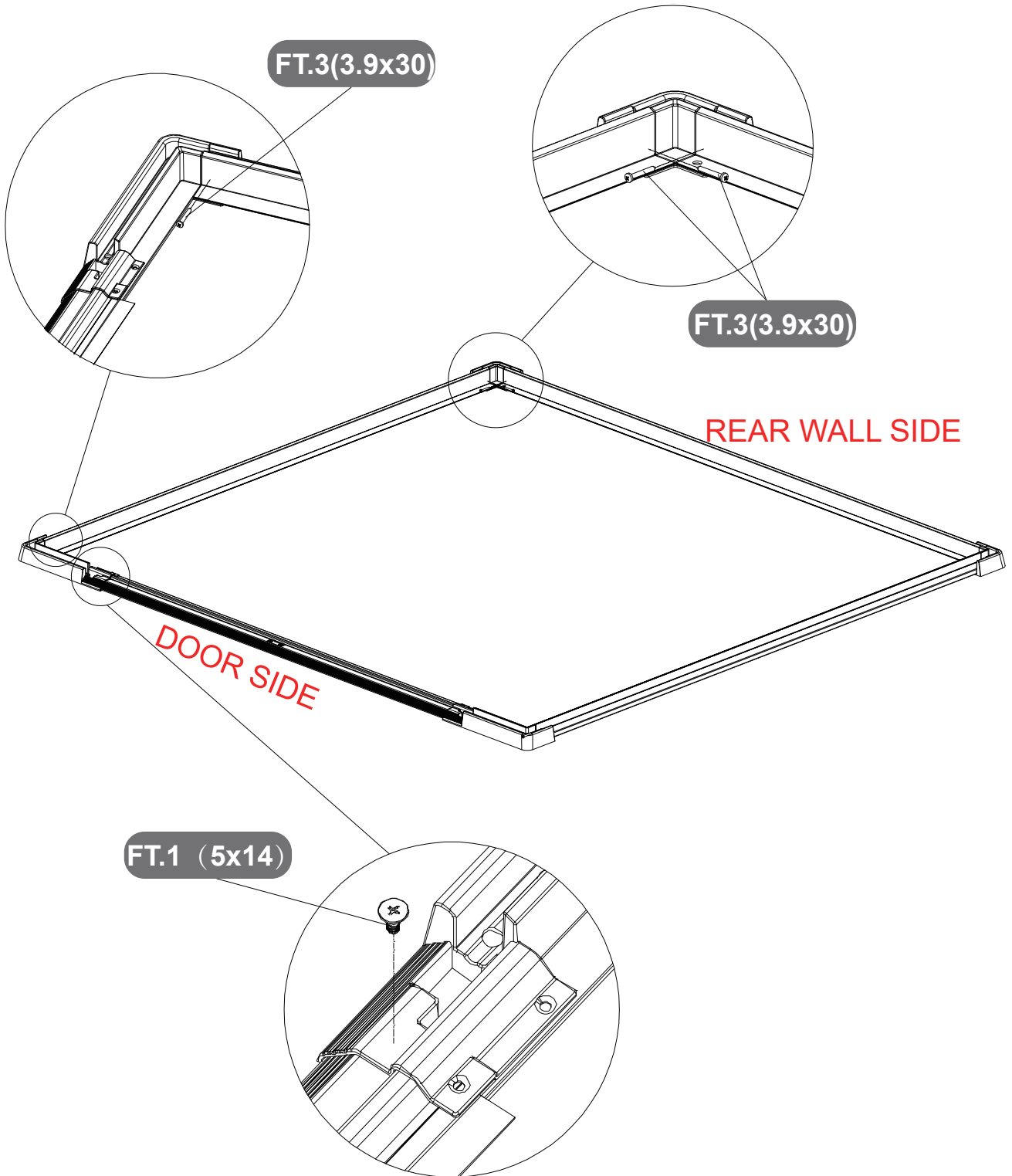

STEP 2

PART	NO	QTY
	FT.3(3.9x30)	6
	FT.1 (5x14)	2



STEP 3



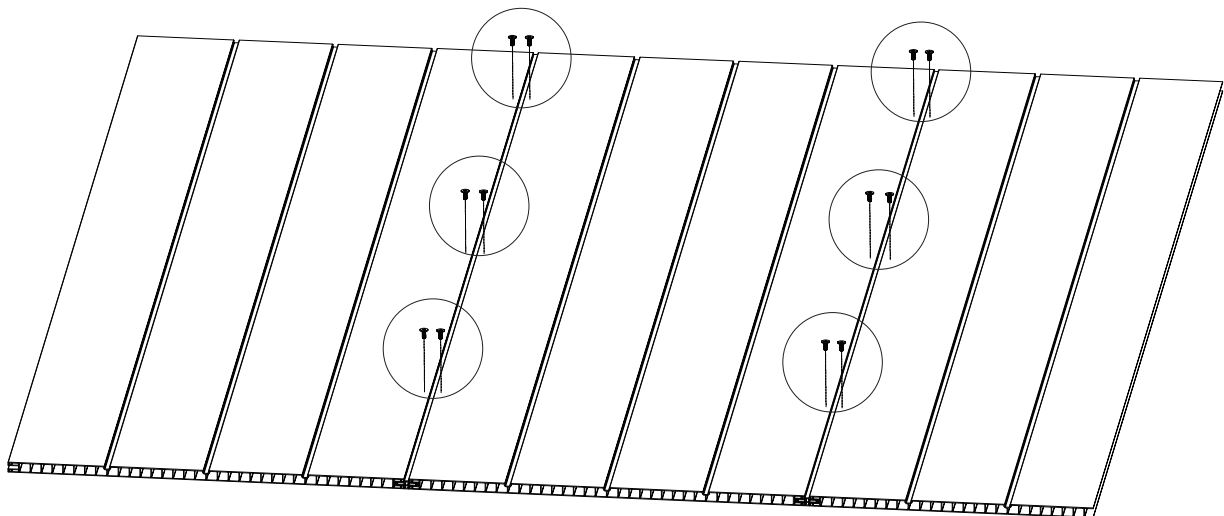
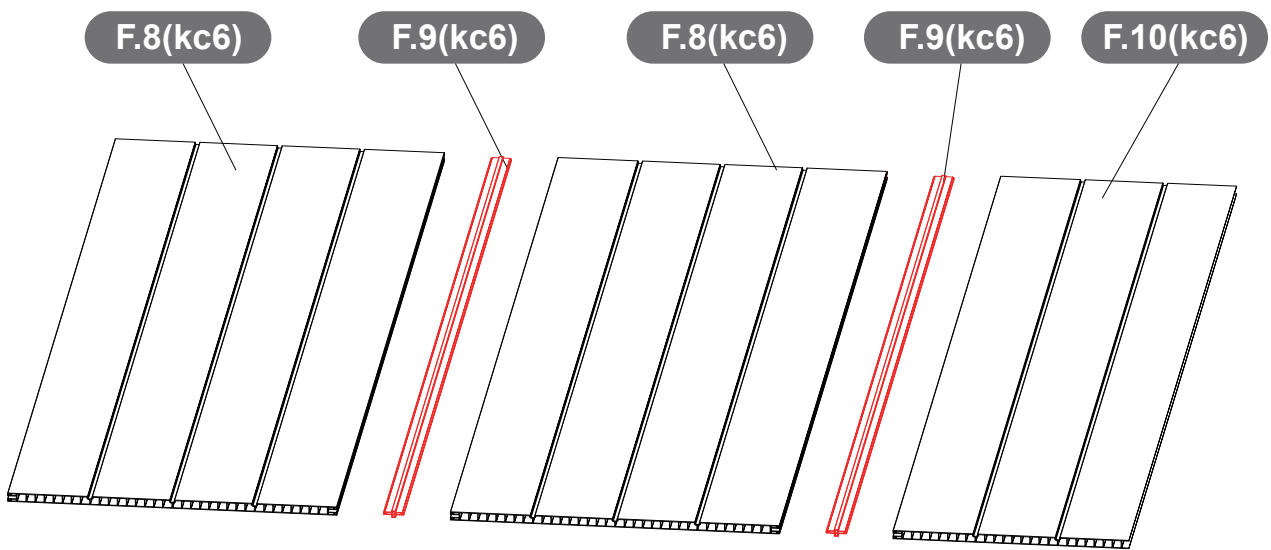

PART	NO	QTY
	F.8(kc6)	2
	F.9(kc6)	2
	F.10(kc6)	1
	FT.1 (5x14)	12

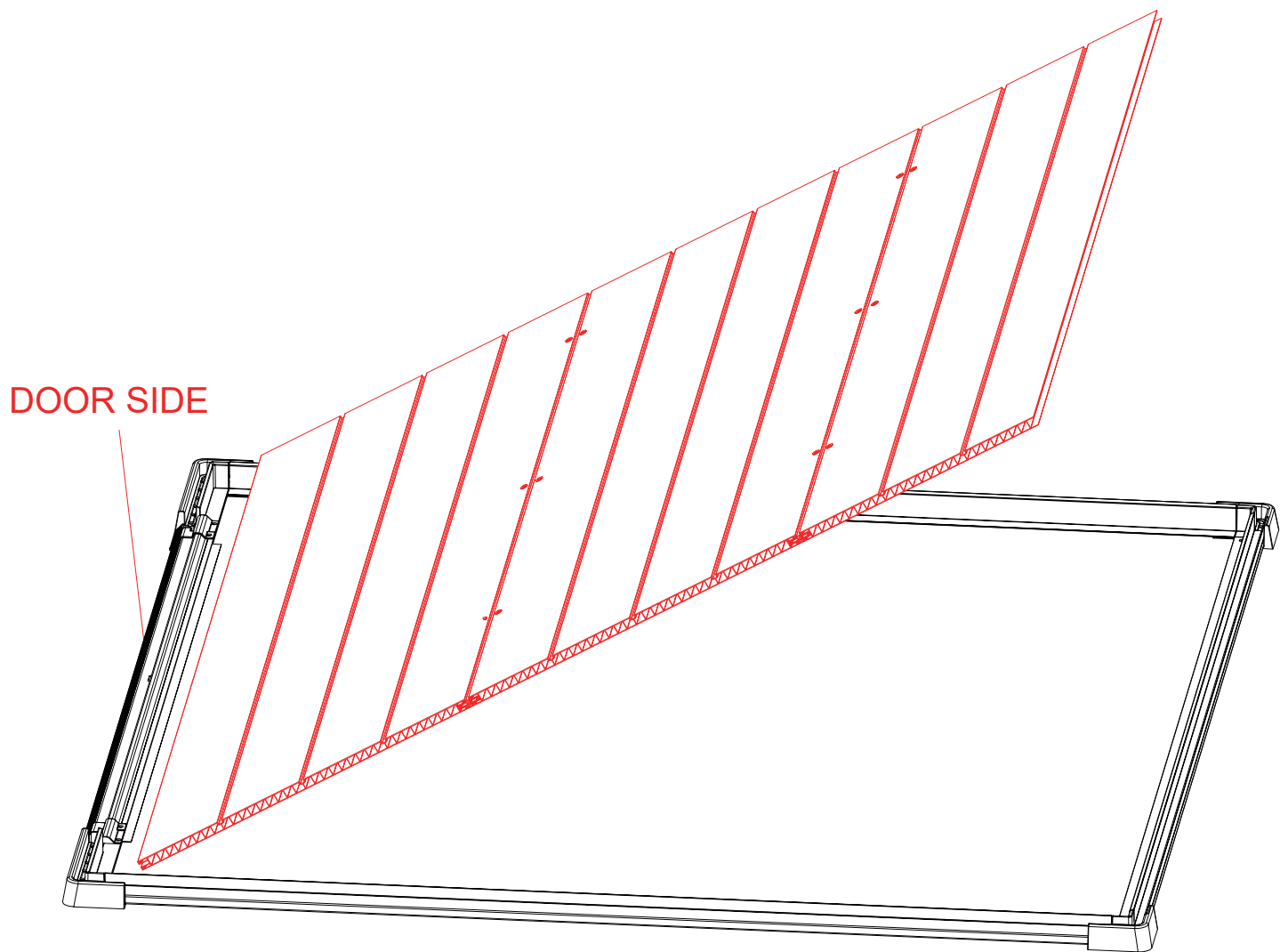

STEP 4



STEP 5

PART	NO	QTY
	F.14(kc46)	2
	F.16(kc6)	1
	F.12(kc6)	1
	F.13(kc6)	1

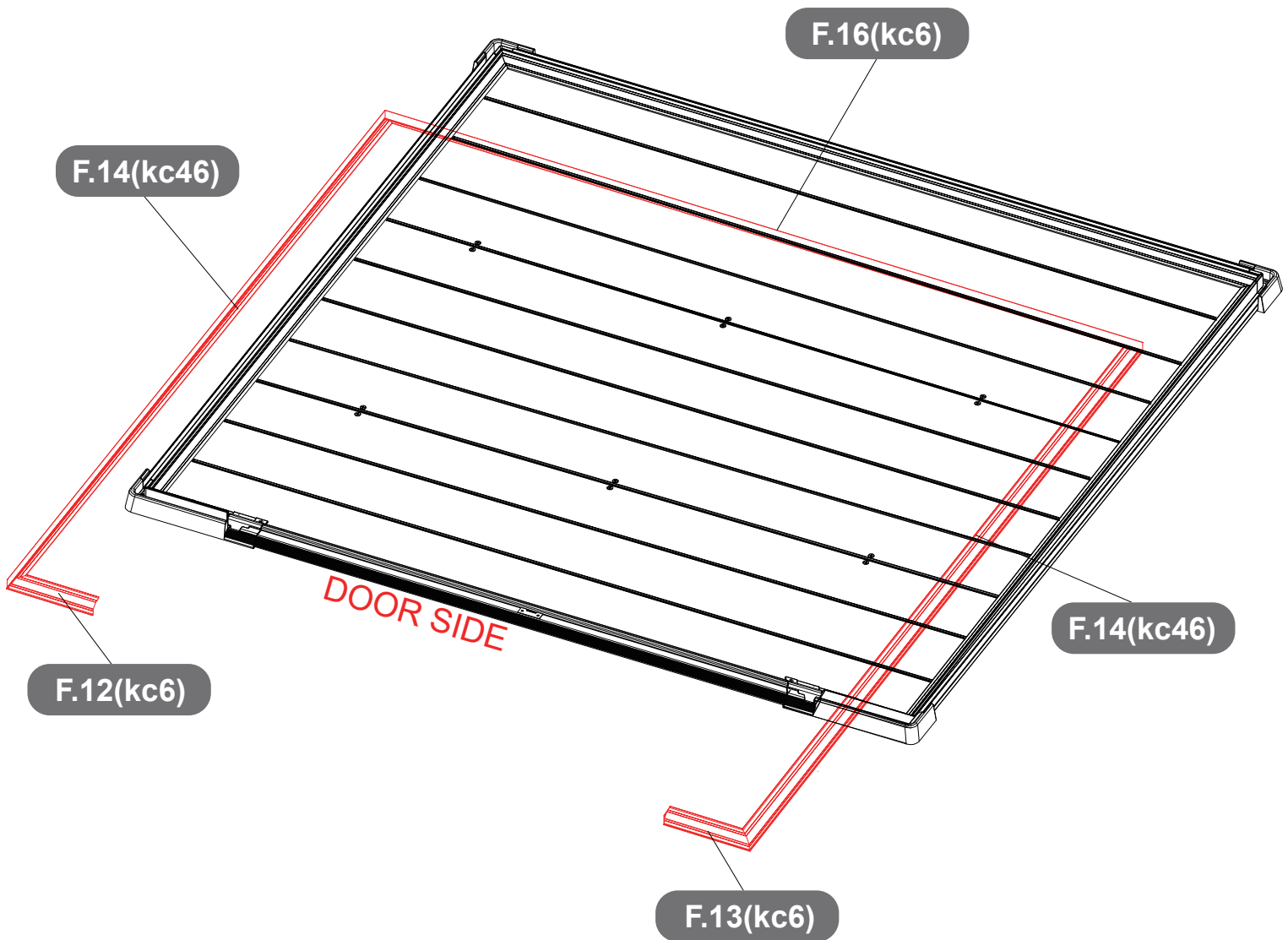

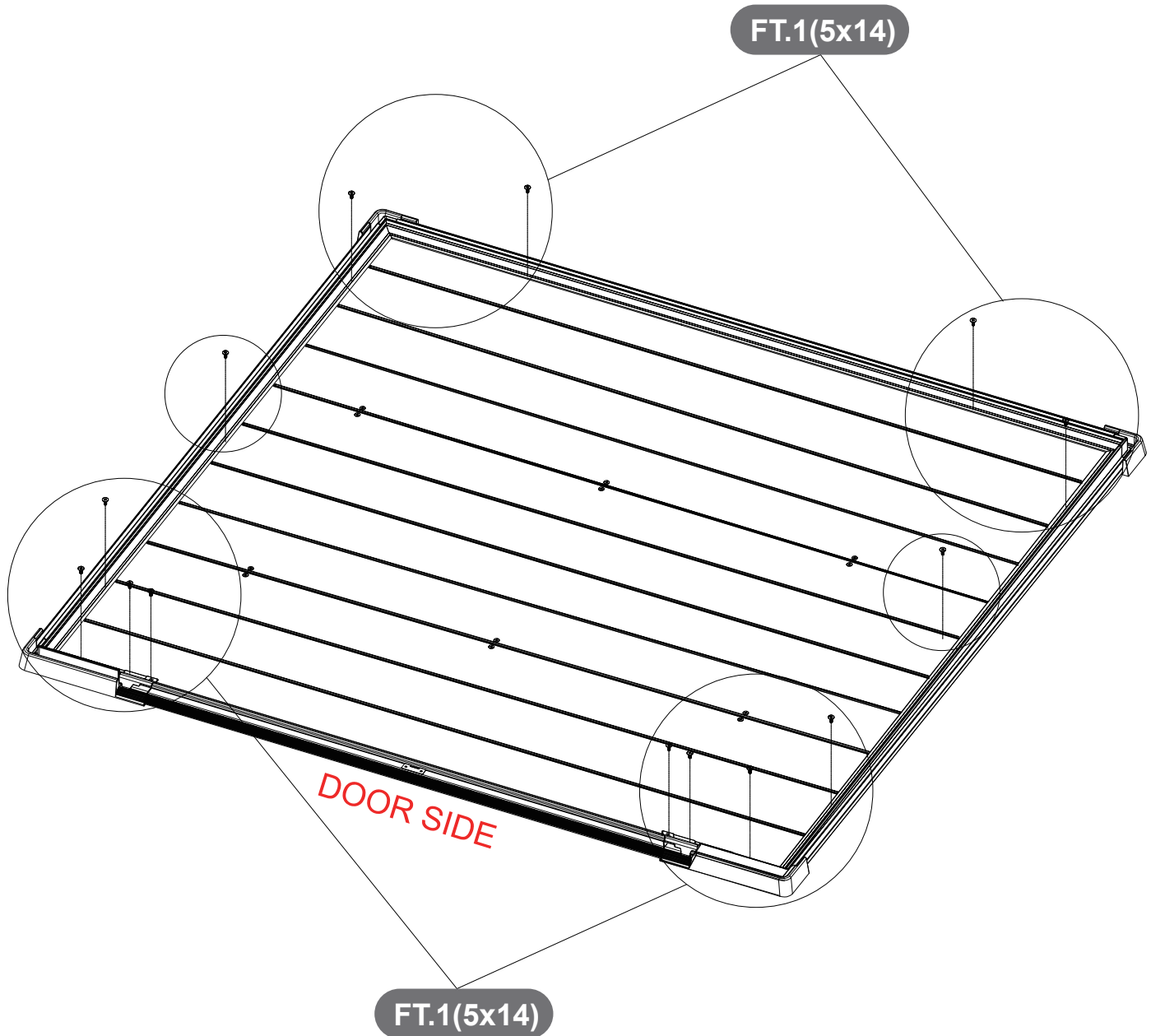

STEP 6

PART	NO	QTY
	FT.1 (5x14)	14



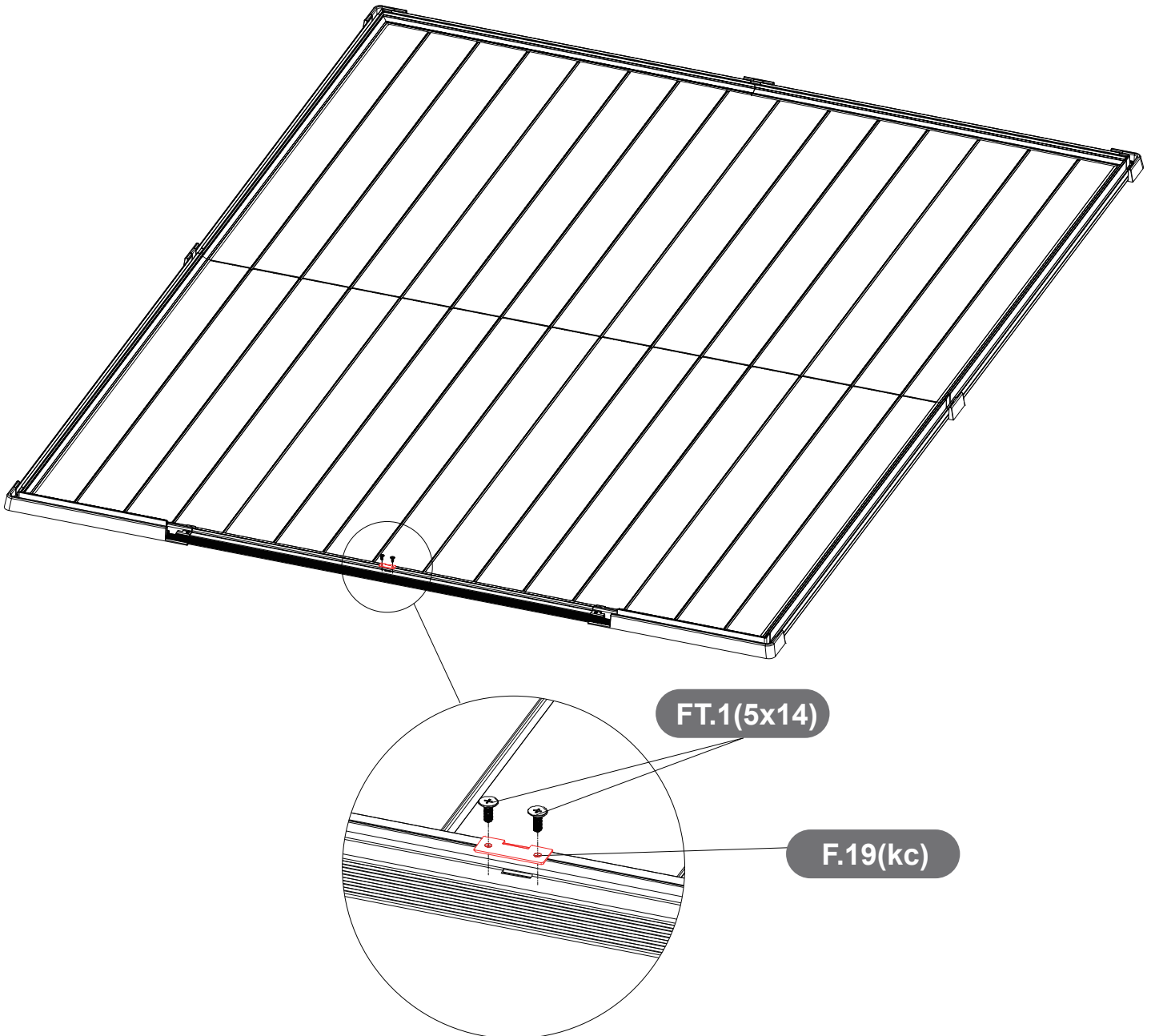

STEP 7

PART	NO	QTY
	FT.1 (5x14)	2
	F.19(kc)	1



STEP 8

NOTE: Bend inward, the smooth surface is on the inside. Please use the plastic guide piece to help insert the wall panels to the bottom.

PART	NO	QTY
	W.1(kc6)	1
	Install the guide piece	2

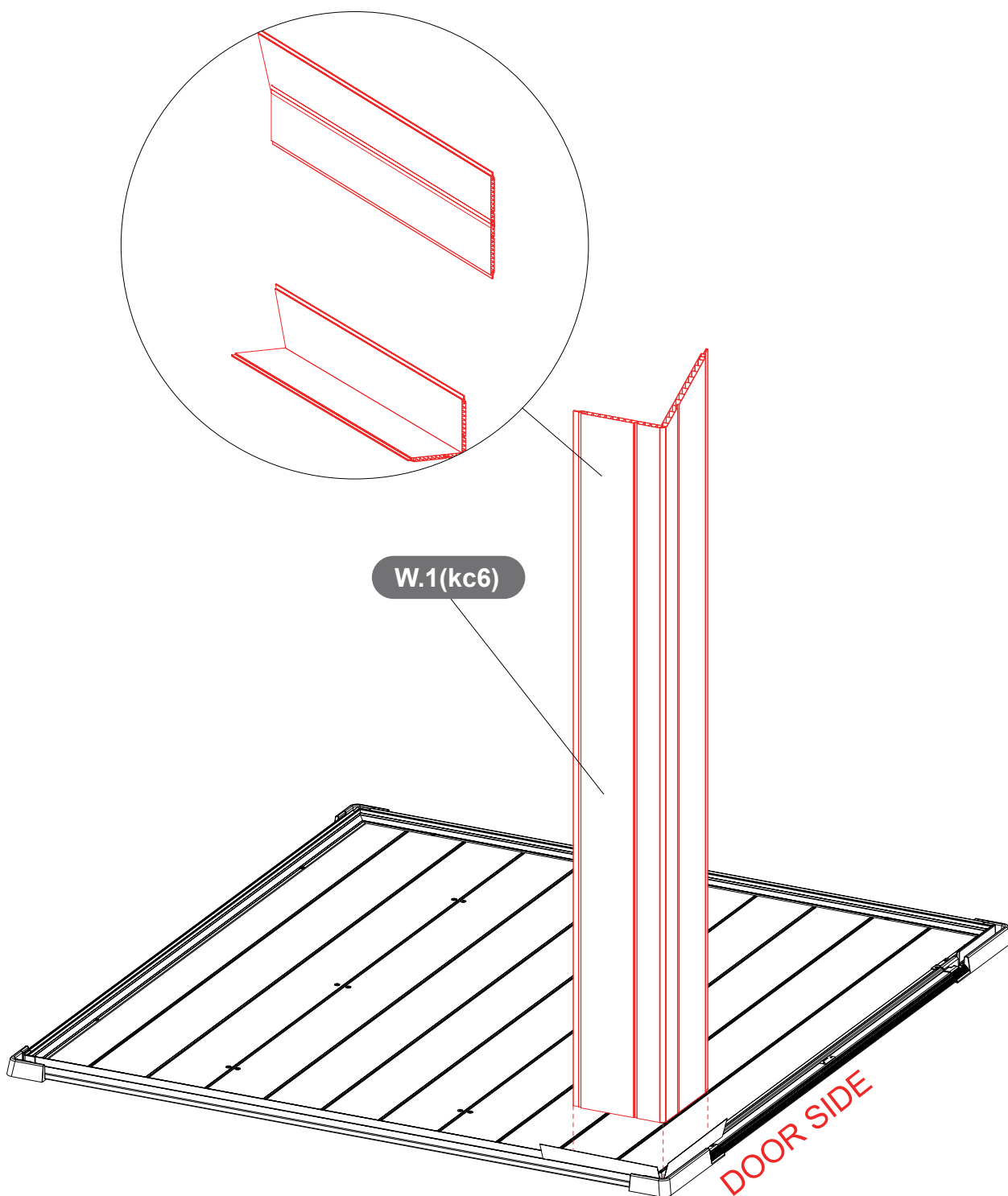

STEP 9

PART	NO	QTY
	W.2(kc6)	1

W.2(kc6)

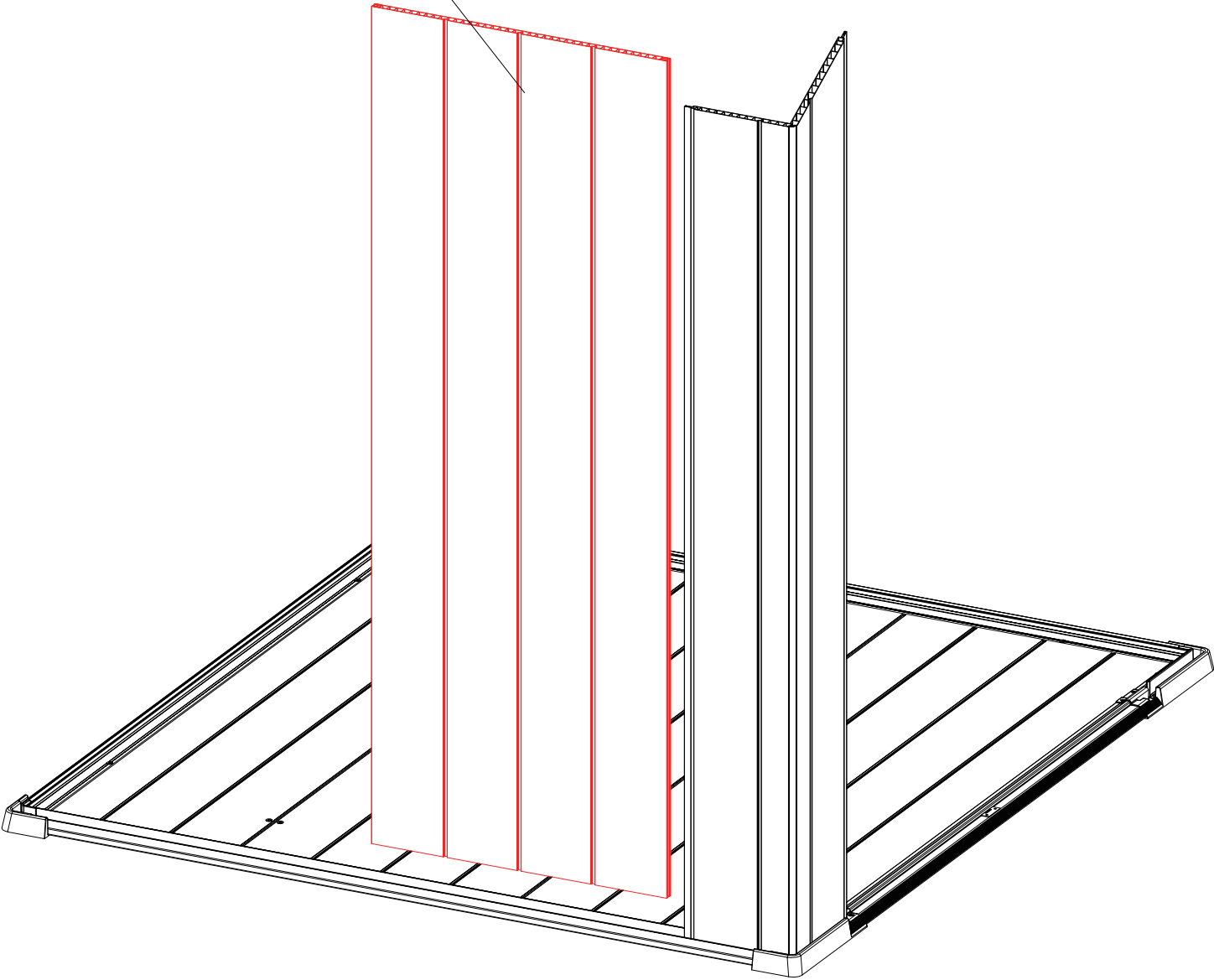

STEP 10

PART	NO	QTY
	W.3(kc6)	1

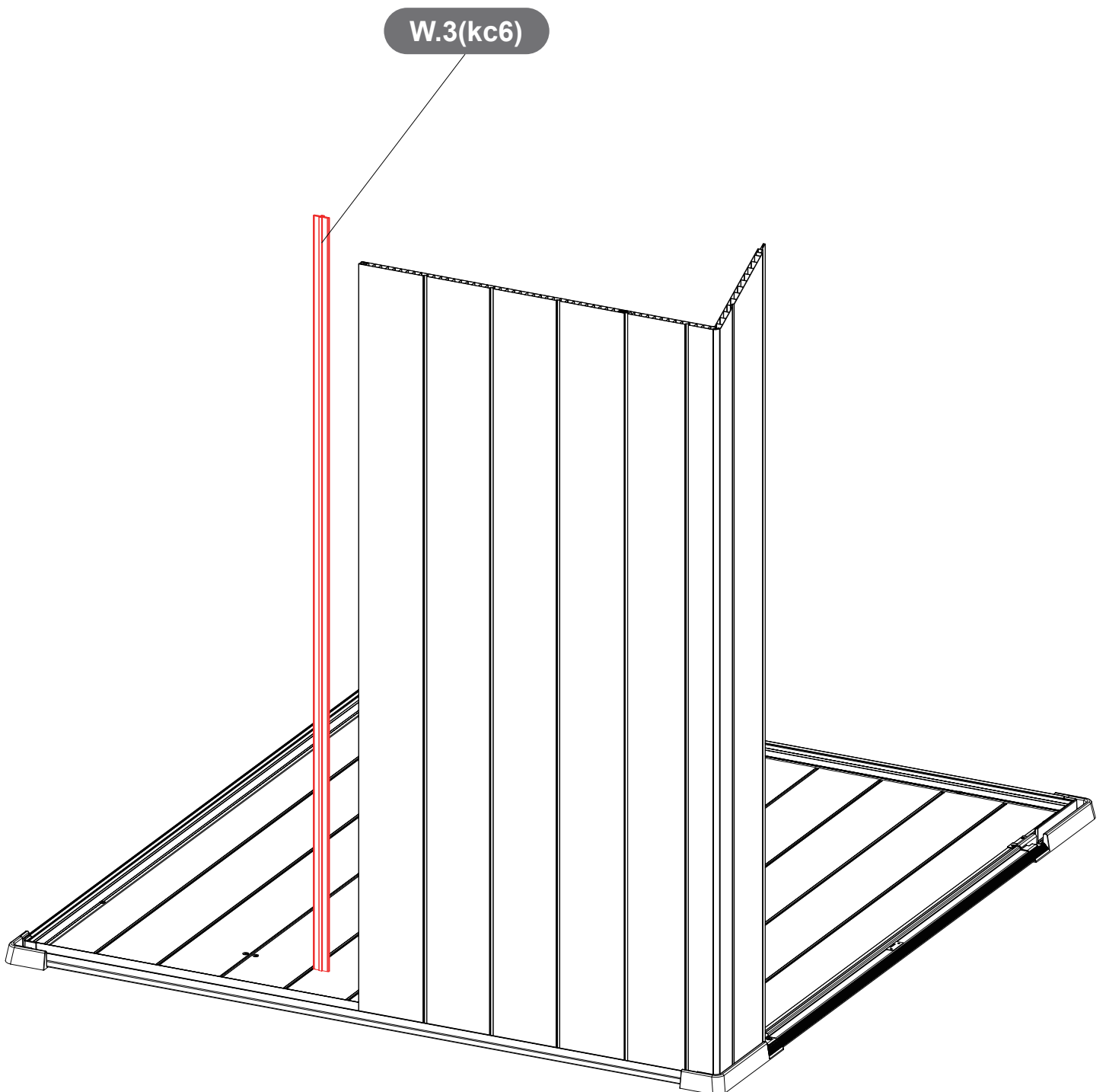



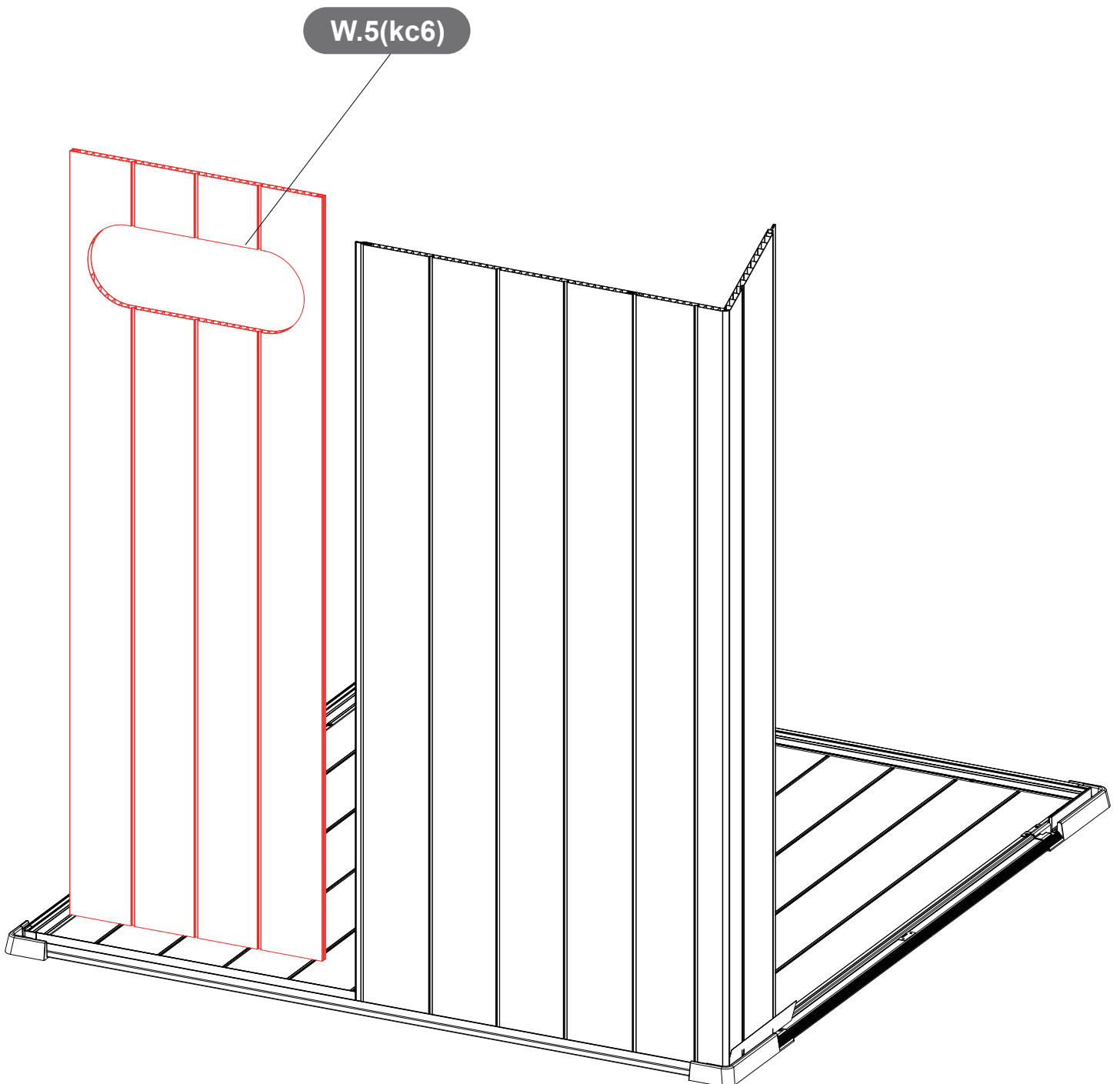

STEP 11

PART	NO	QTY
	W.5(kc6)	1



STEP 12

PART	NO	QTY
	WIR2.OUT	1
	WIR2.IN	1
	FT.5(2.9x20)	12
	WIR2.PC	1

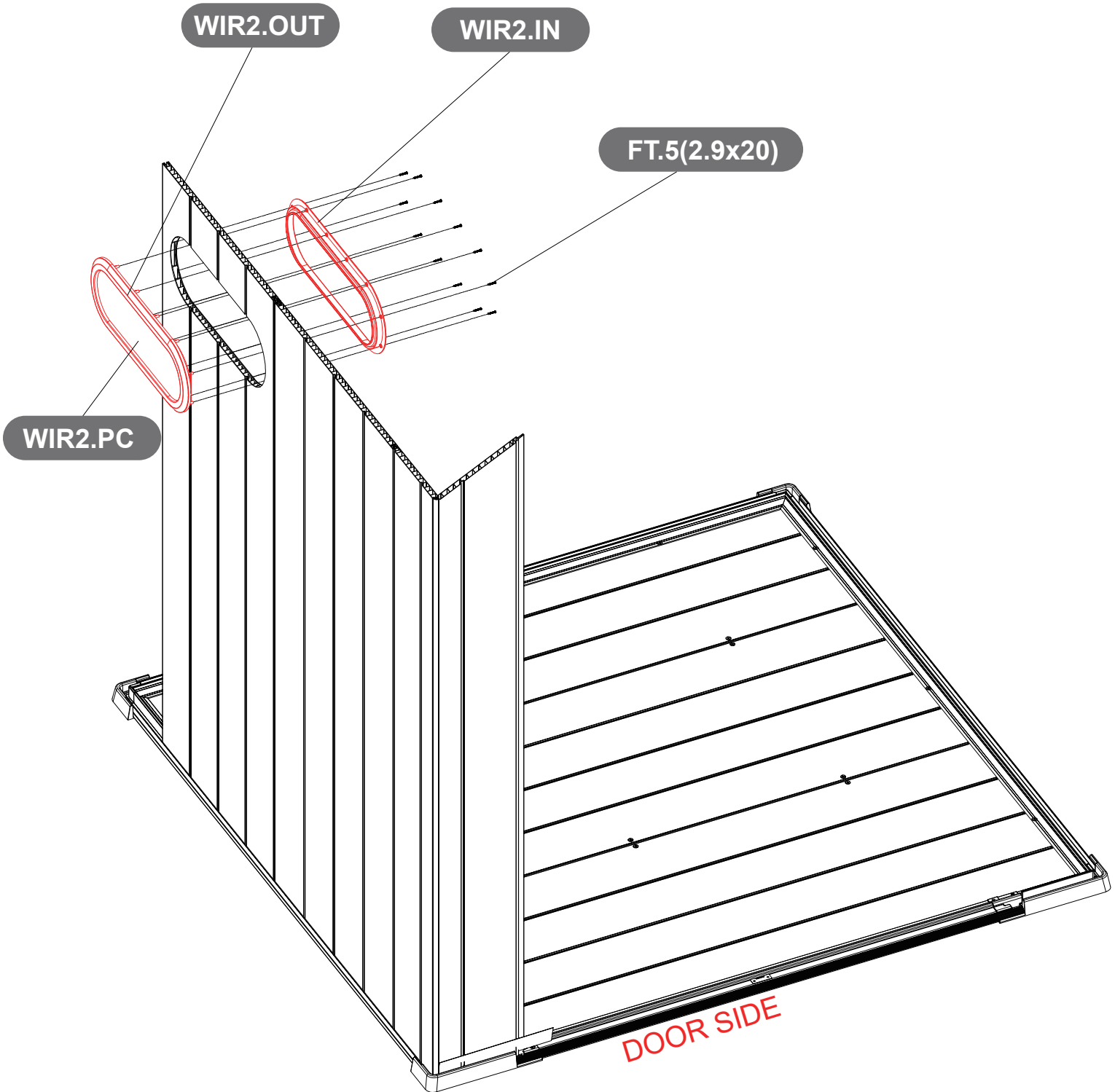

STEP 13

PART	NO	QTY
	W.6(kc6)	1

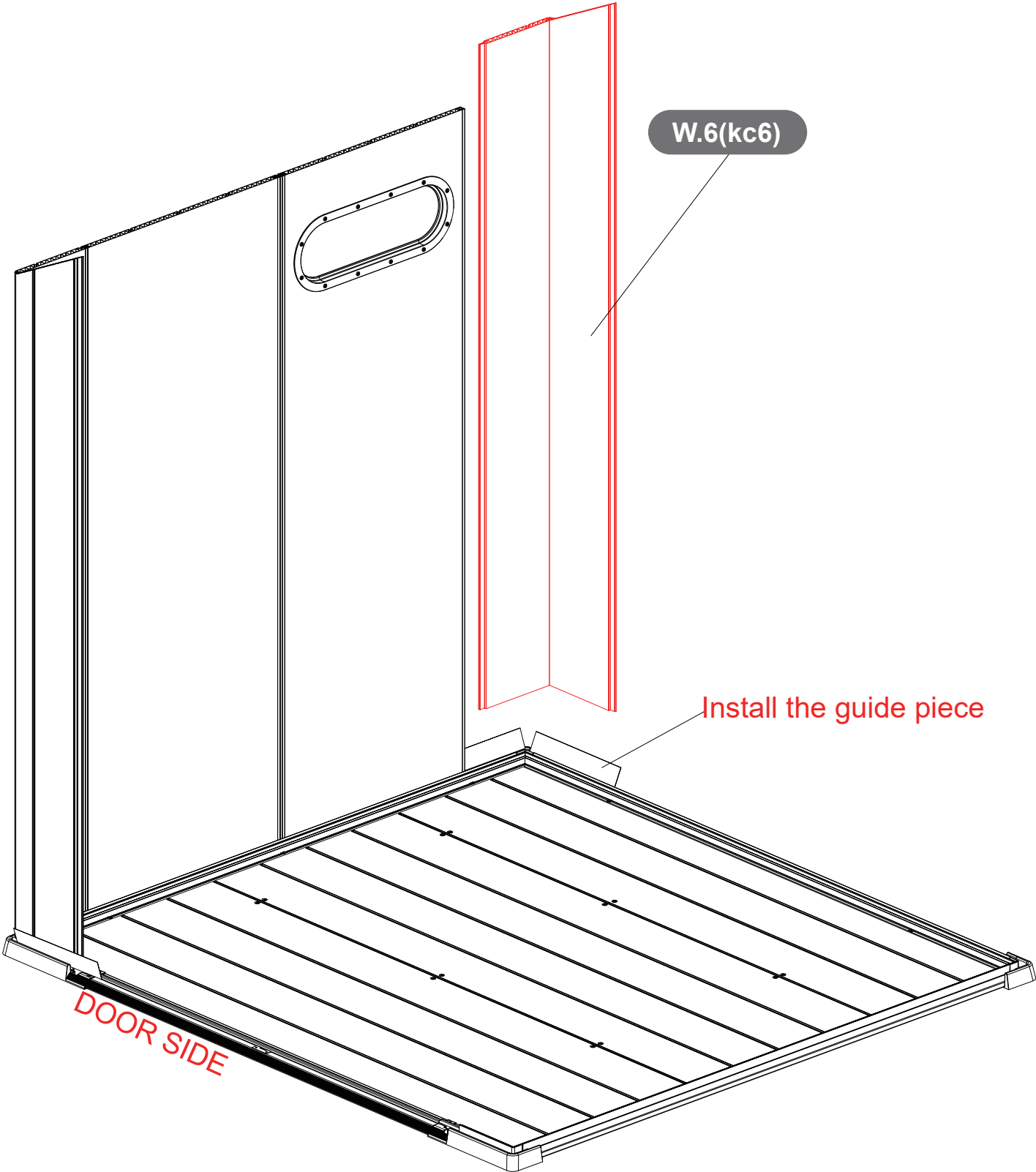

STEP 14

PART	NO	QTY
	W.2(kc)	1

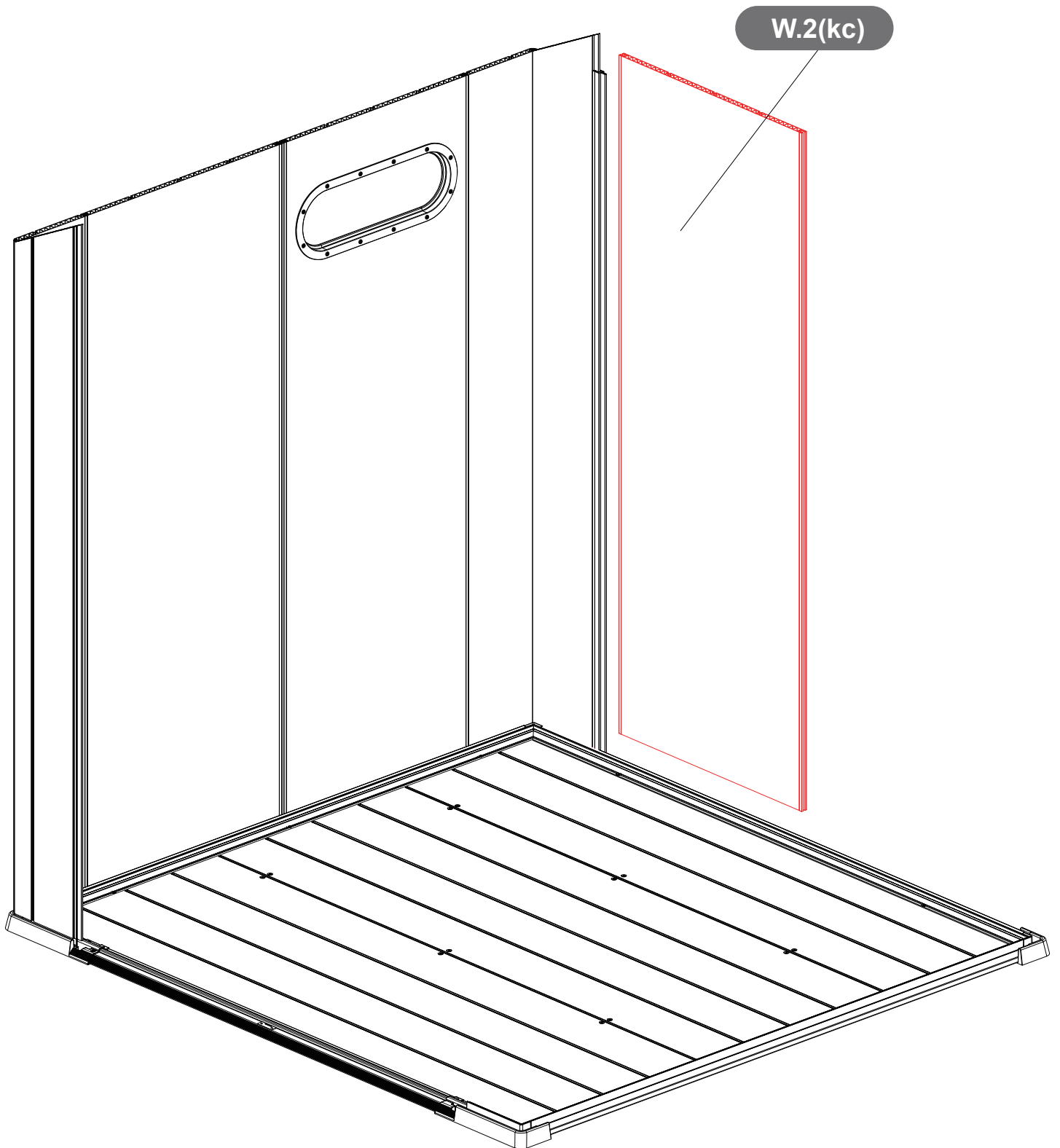

STEP 15

PART	NO	QTY
	W.7(kc6)	1

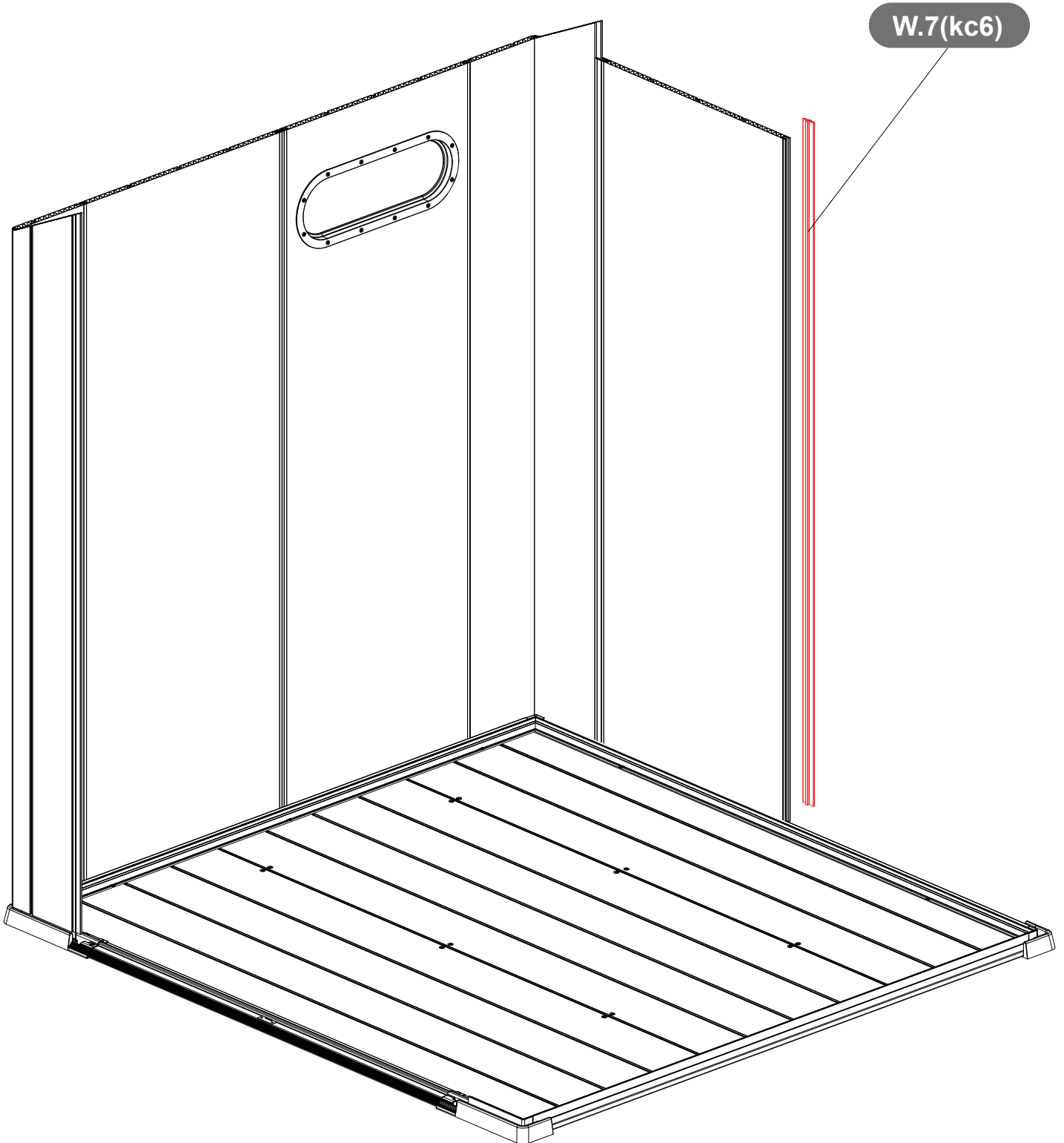

STEP 16

PART	NO	QTY
	W.2(kc)	1

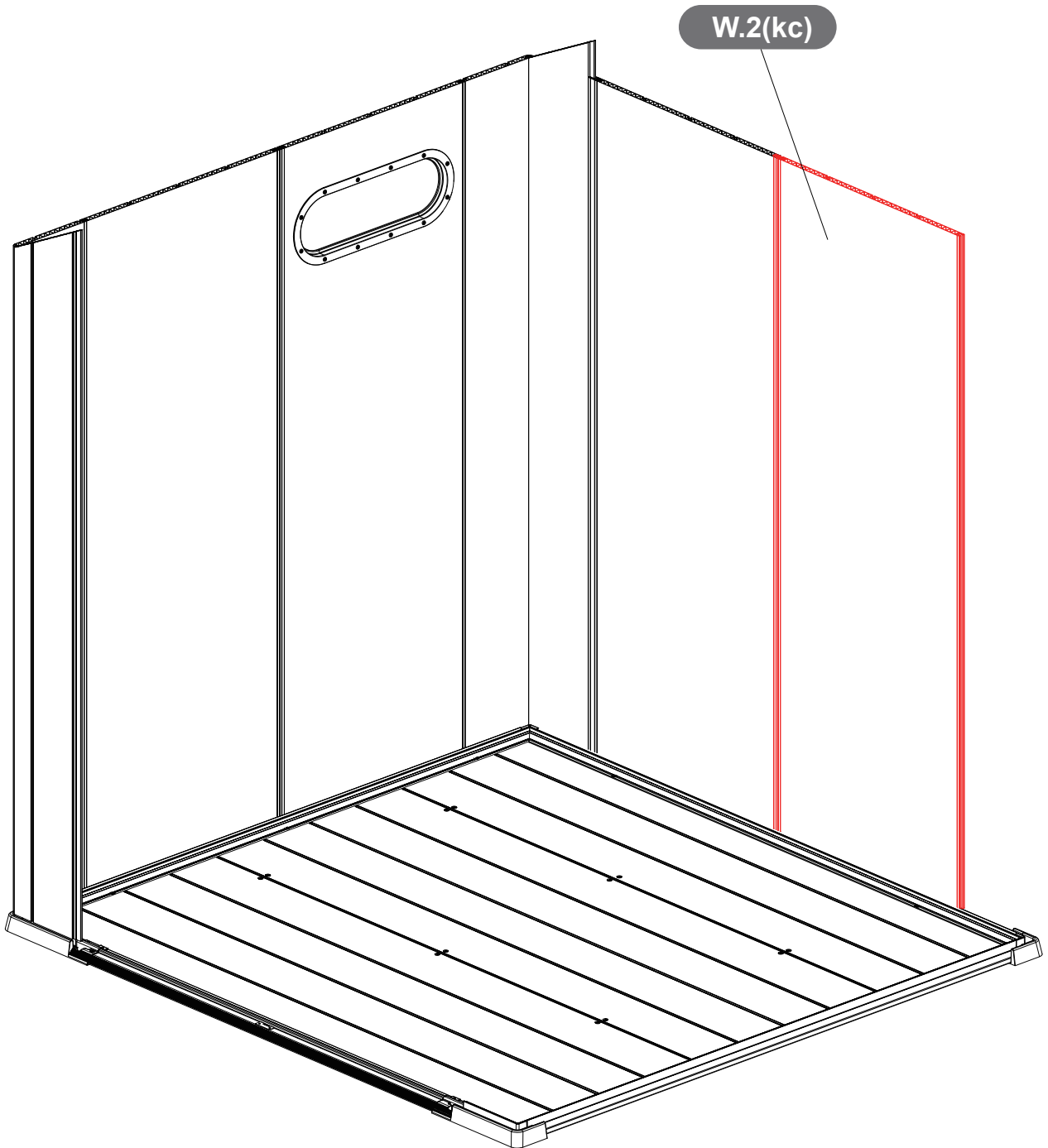

STEP 17

PART	NO	QTY
	W.1(kc6)	1

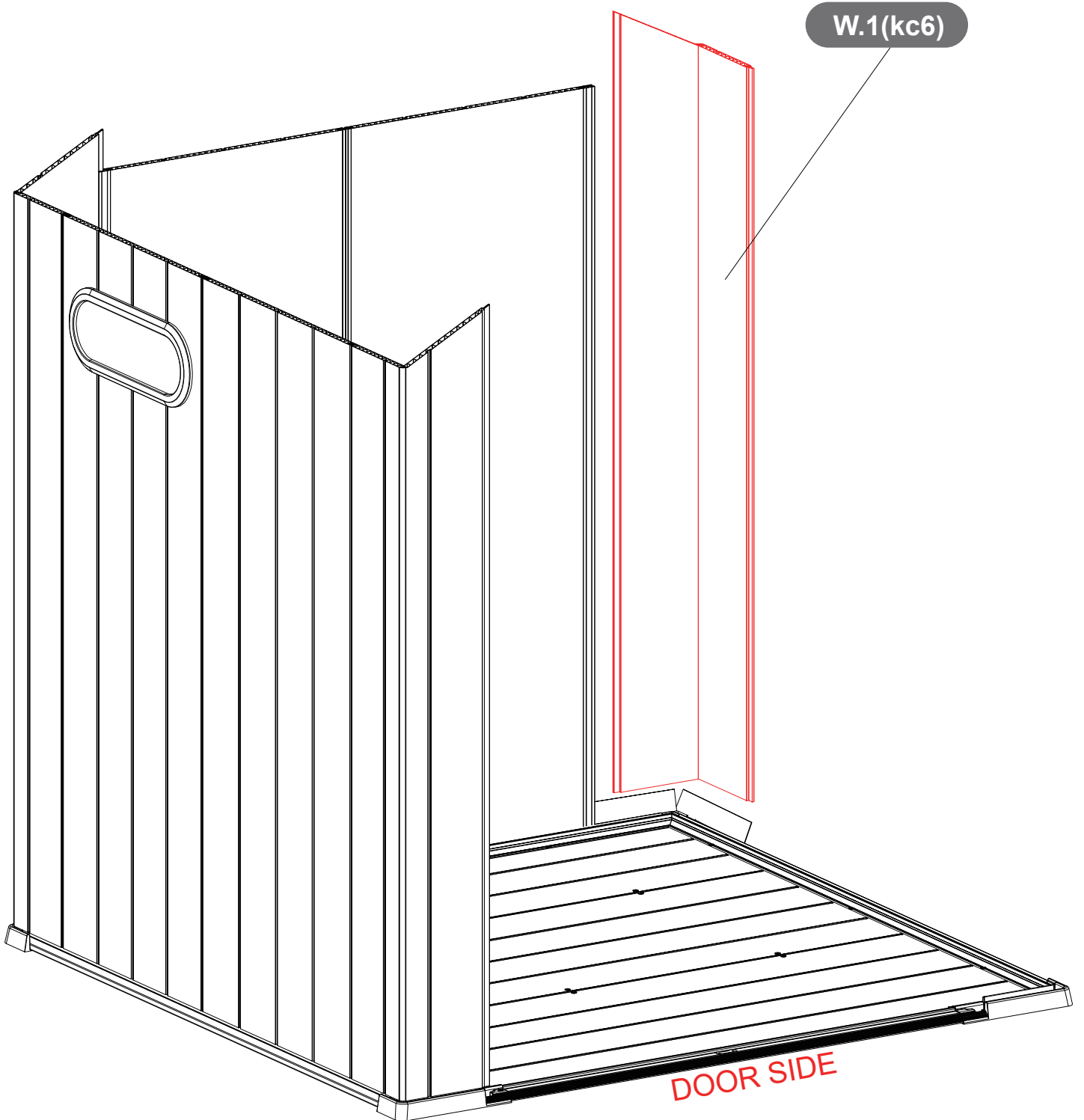

STEP 18

PART	NO	QTY
	W.4(kc6)	1

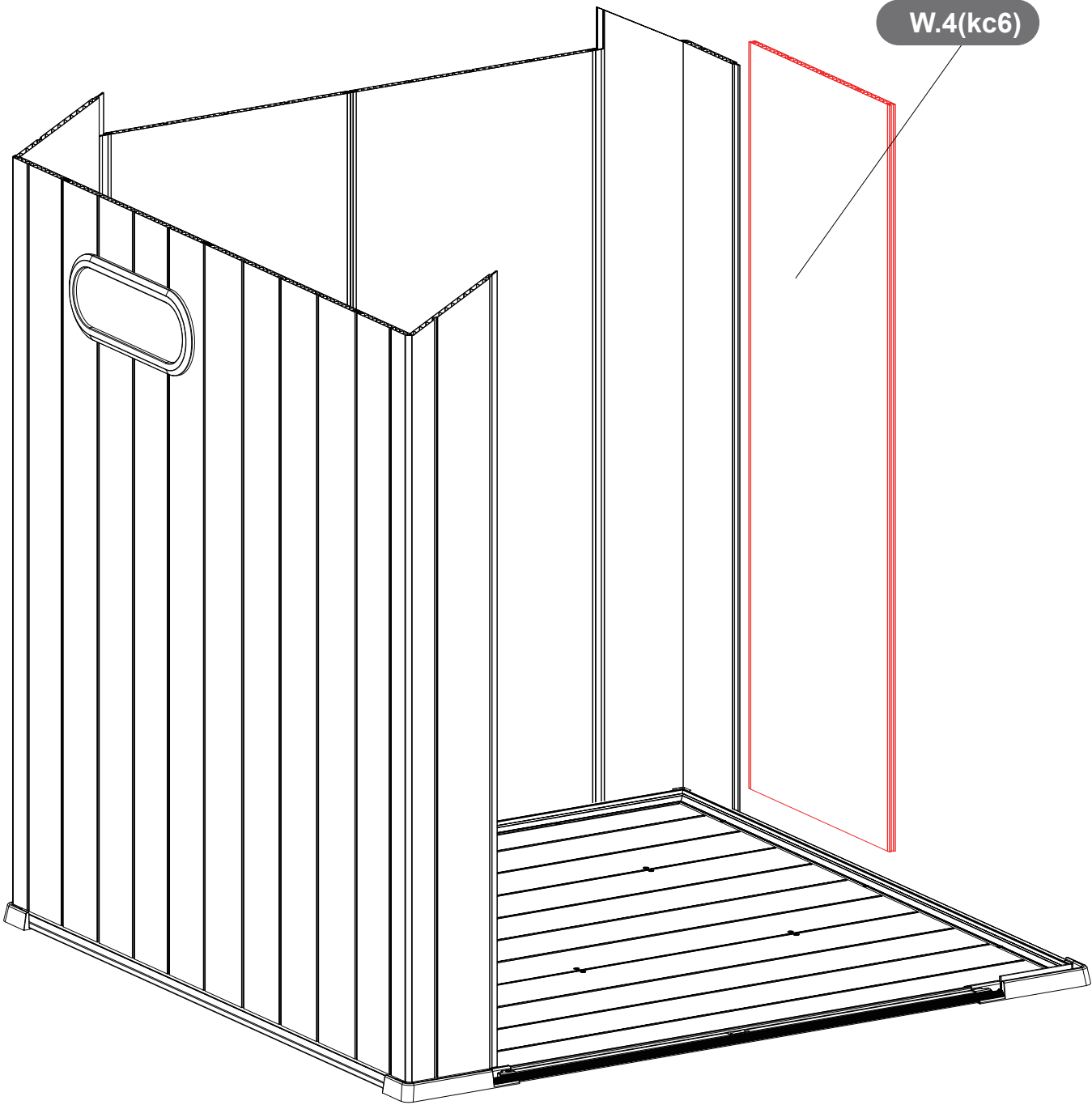

STEP 19

PART	NO	QTY
	W.3(kc6)	1

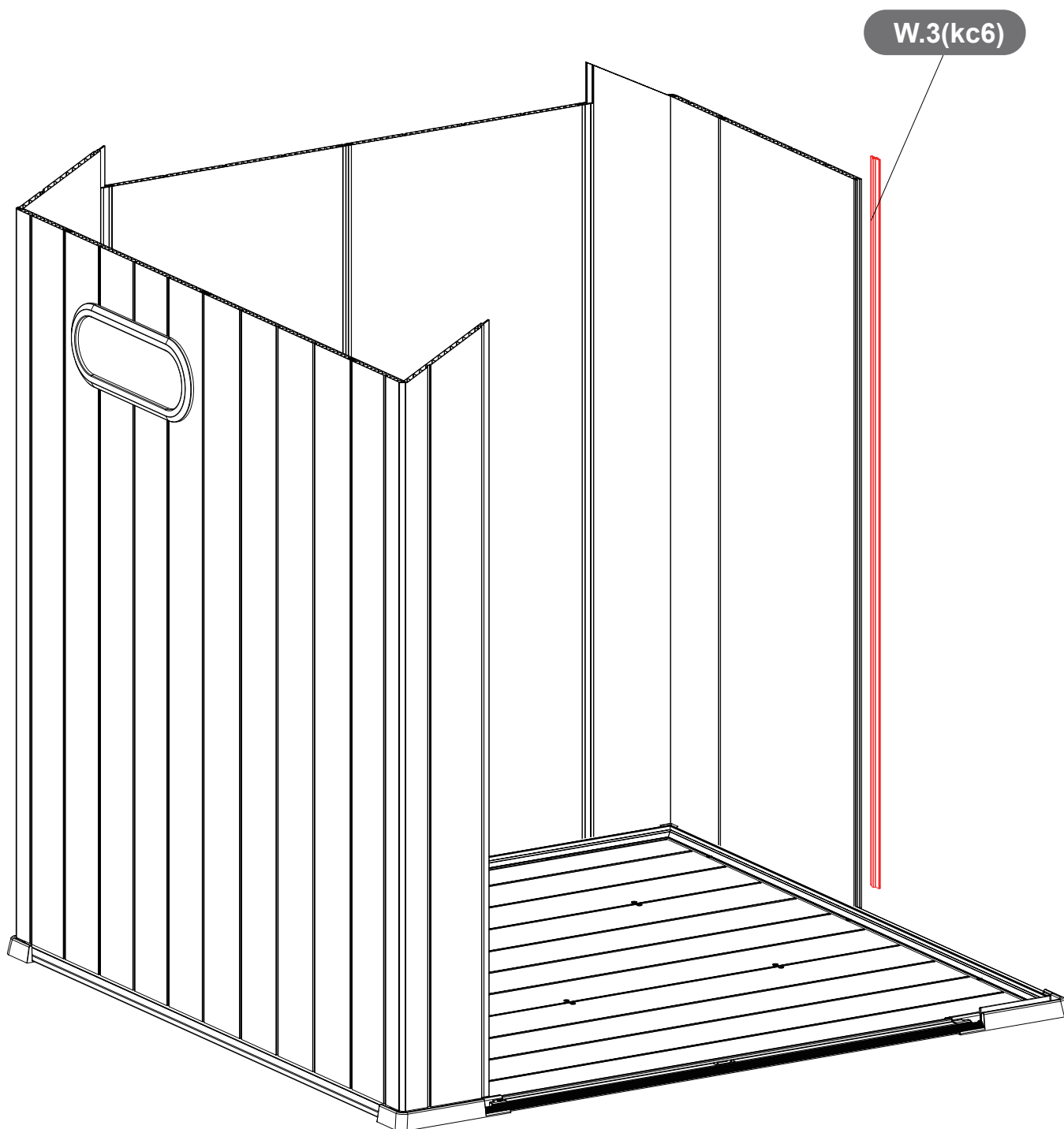

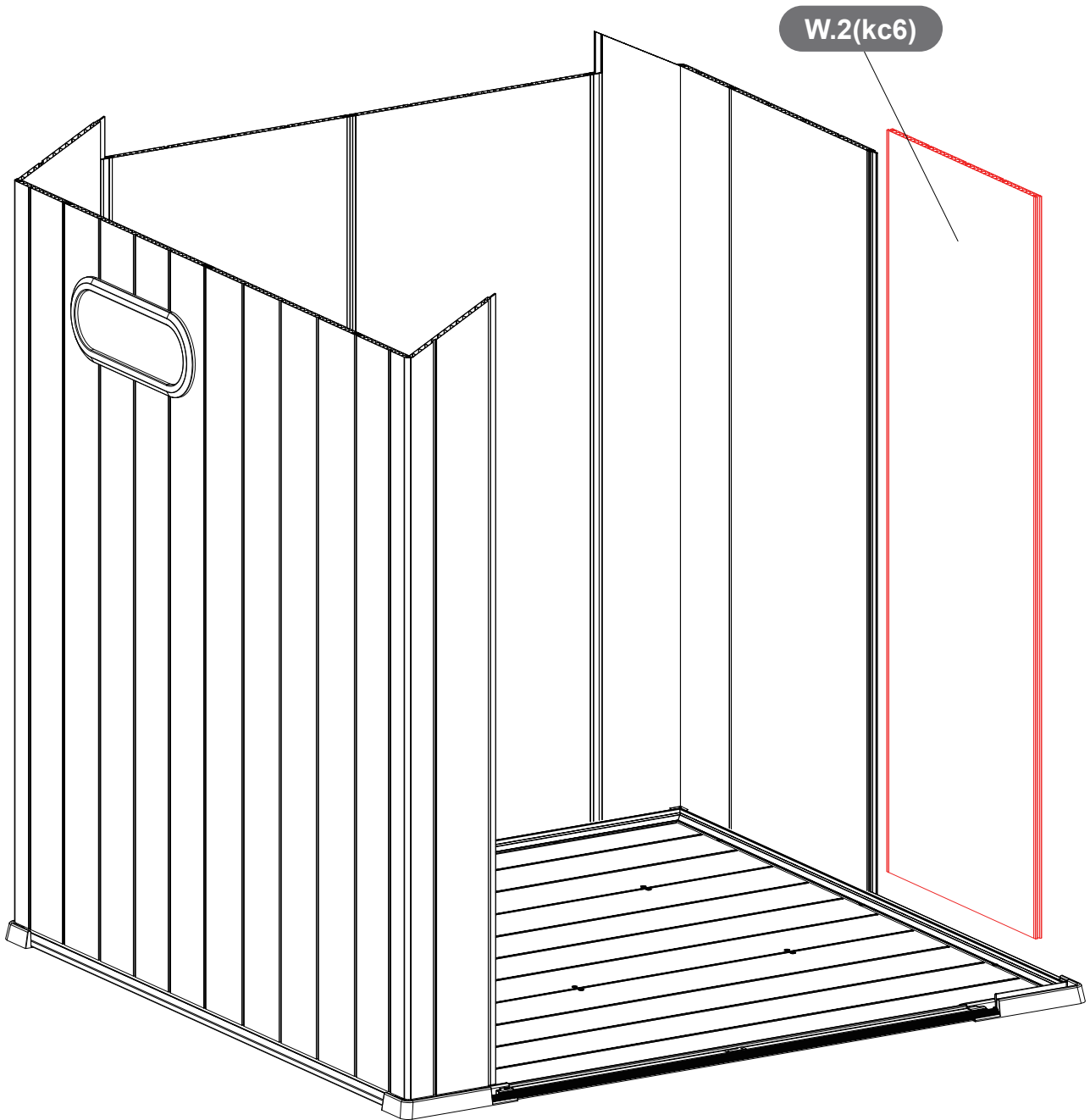

STEP 20

PART	NO	QTY
	W.2(kc6)	1



STEP 21

NOTE: Please use the plastic guide pieces to help insert the wall panels to the bottom.

PART	NO	QTY
	W.6(kc6)	1
	Install the guide piece	2

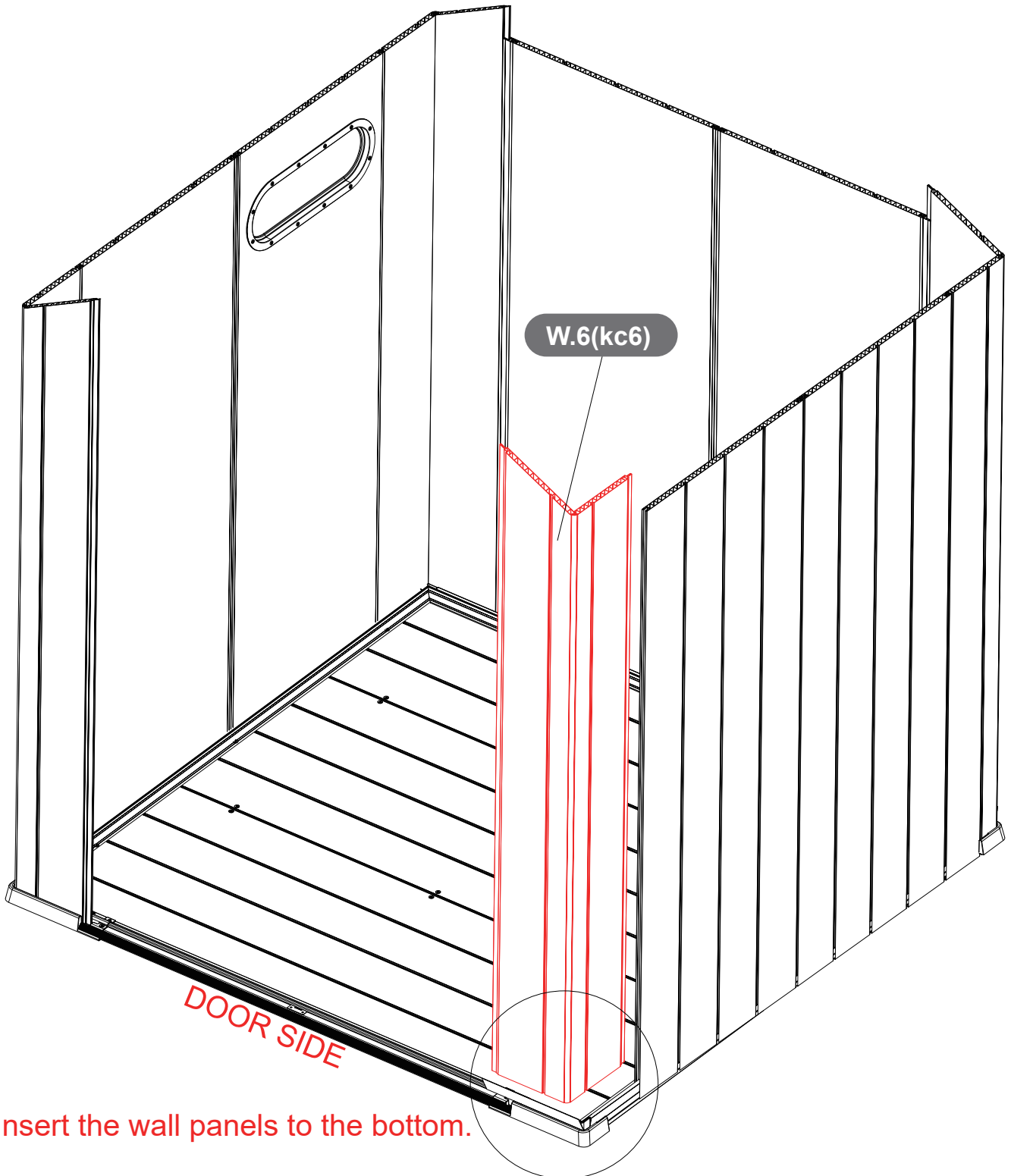

STEP 22

PART	NO	QTY
	W.8(kc6)	1
	W.9(kc6)	1

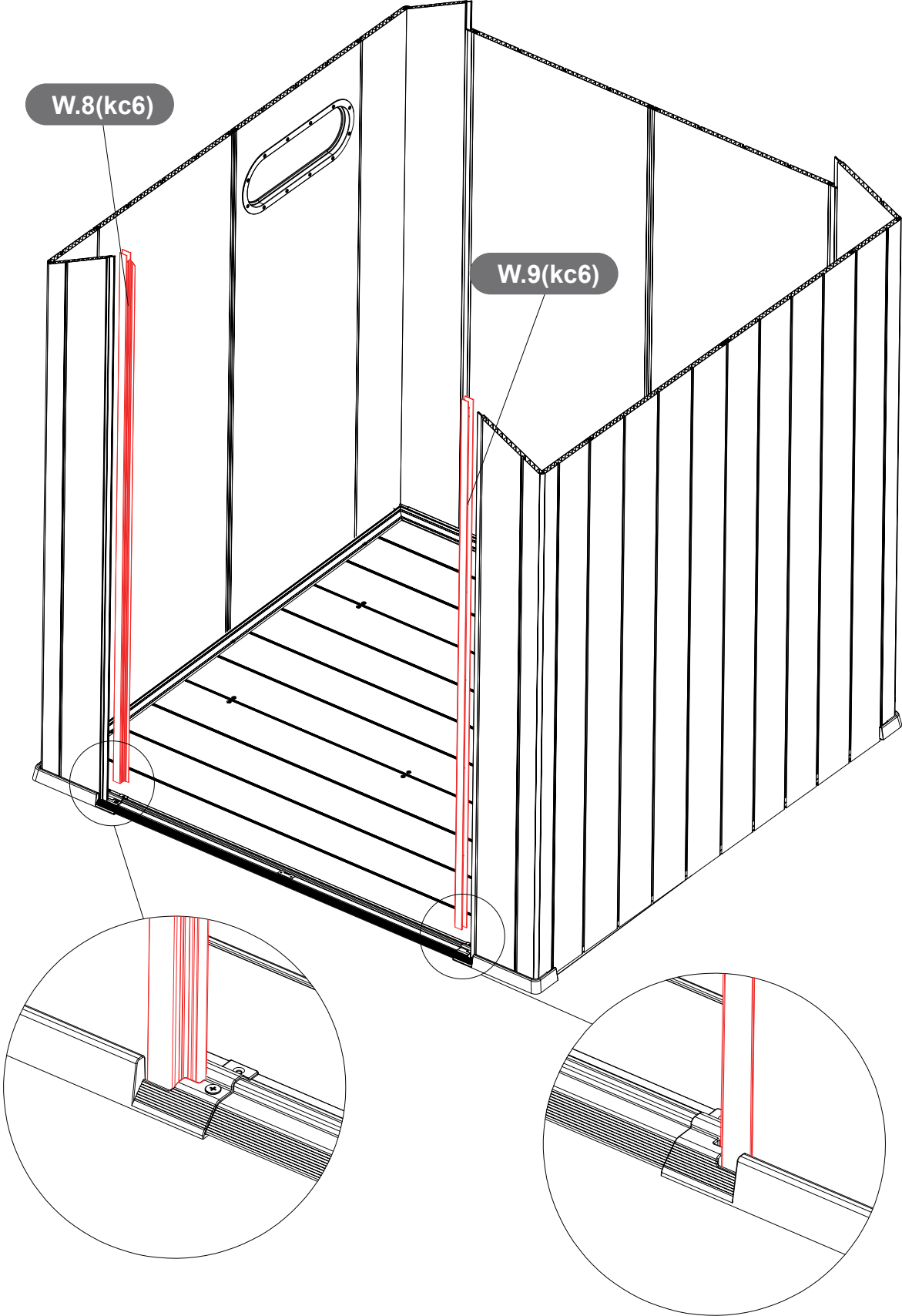

STEP 23

PART	NO	QTY
/ H	W.11(kc6)	1

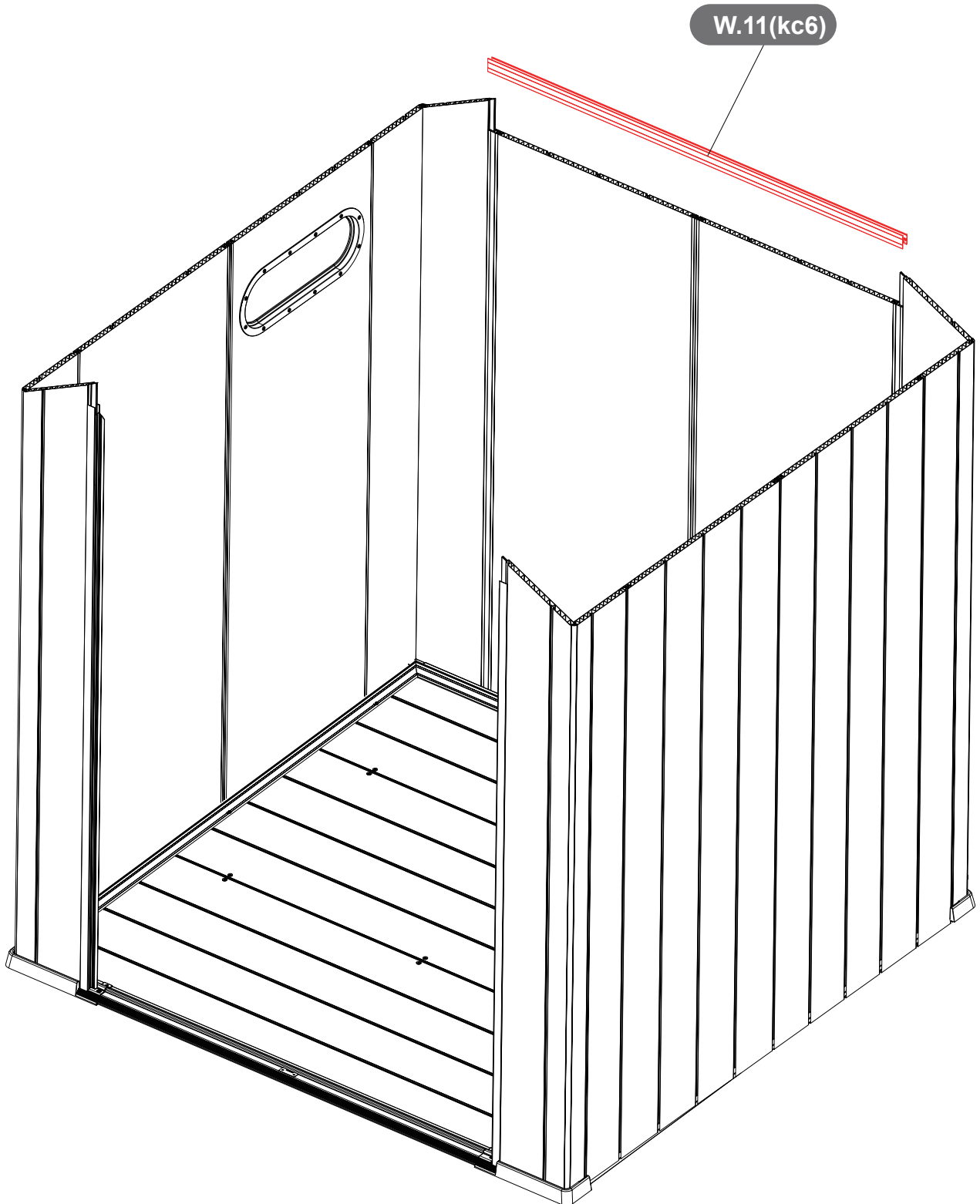





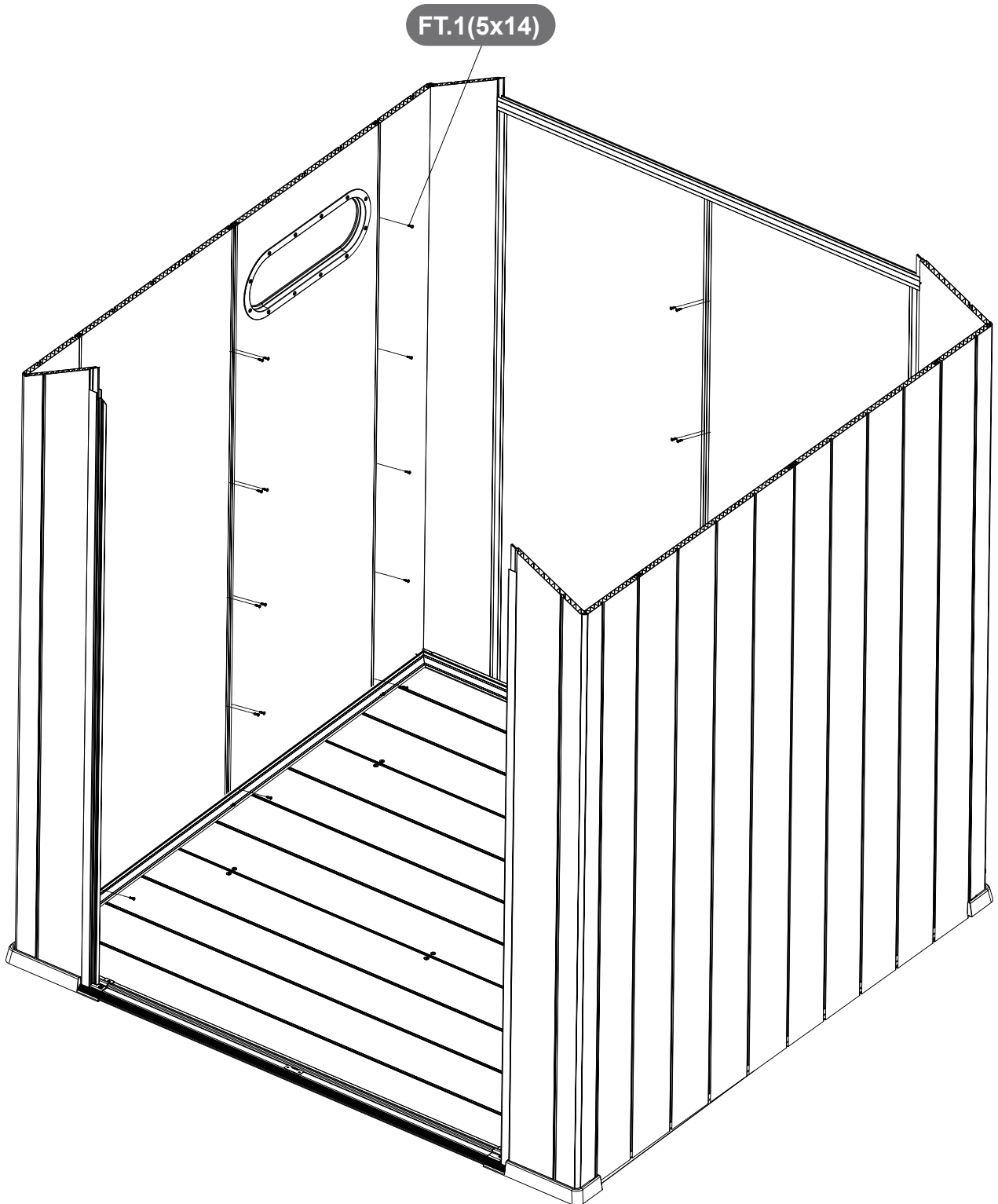

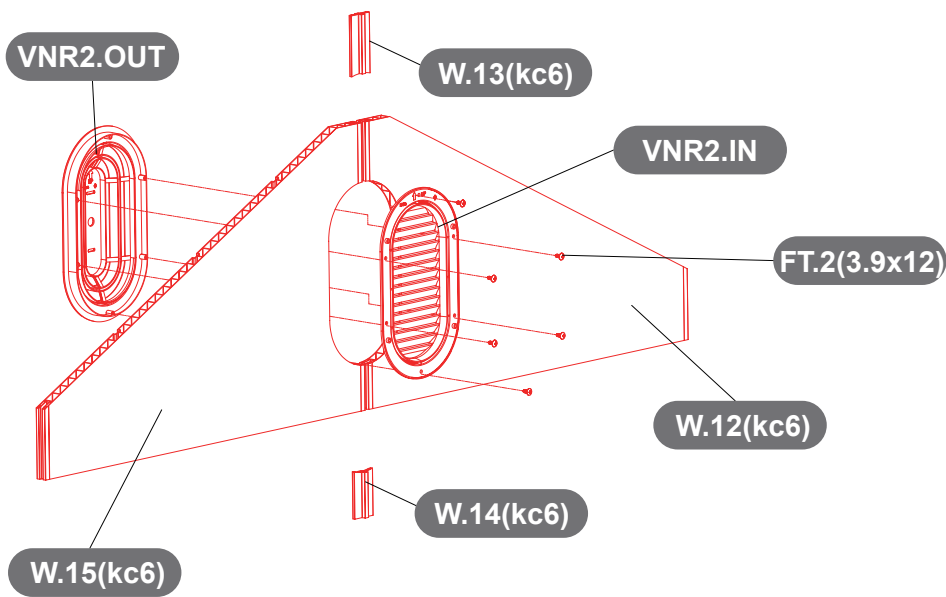

STEP 24

PART	NO	QTY
	FT.1 (5x14)	70





STEP 25

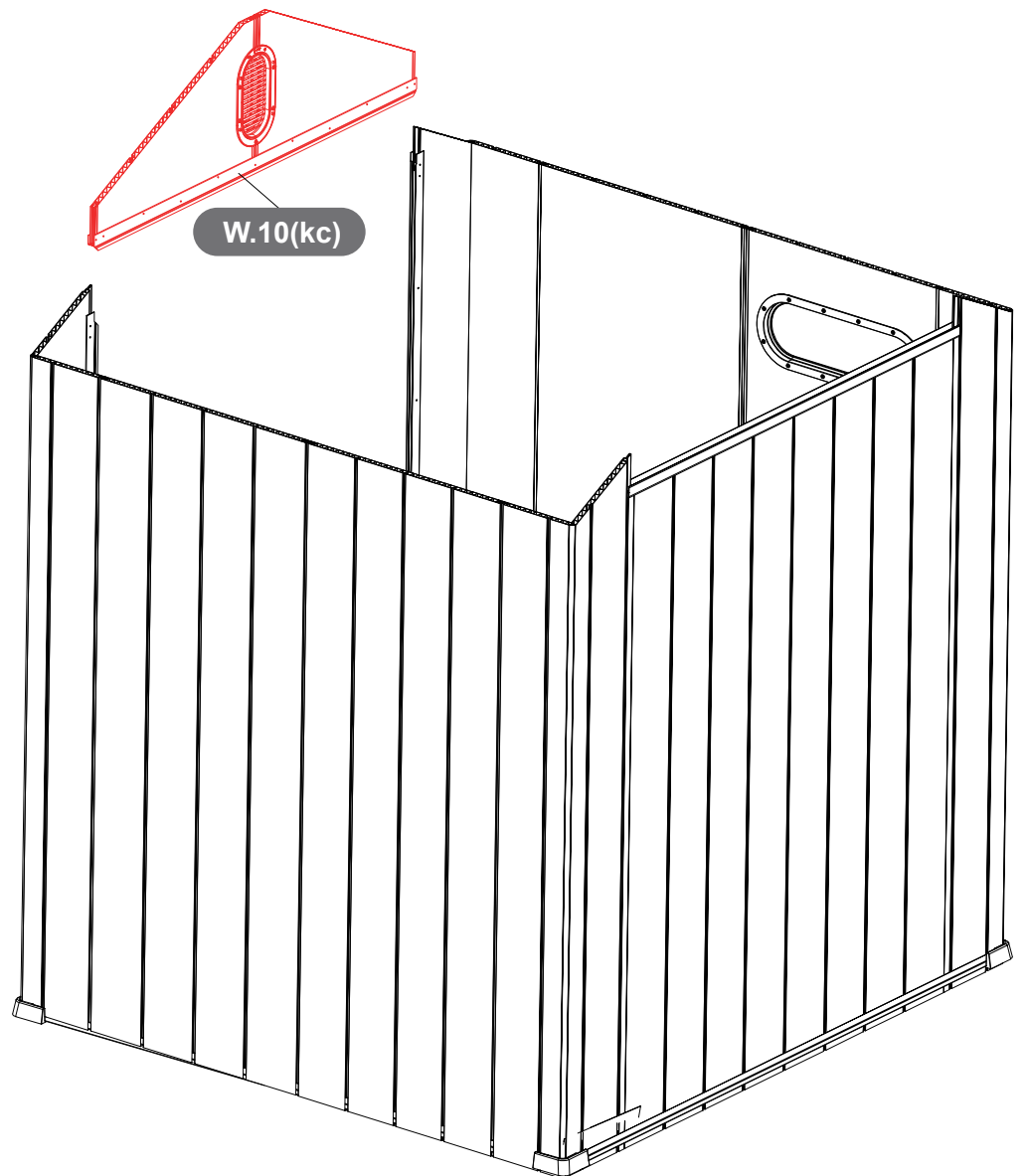

PART	NO	QTY
	VNR2.OUT	1
	VNR2.IN	1
	W.13(kc6)	1
	W.14(kc6)	1
	W.15(kc6)	1
	W.12(kc6)	1
	FT.2(3.9x12)	6
	W.10(kc)	1







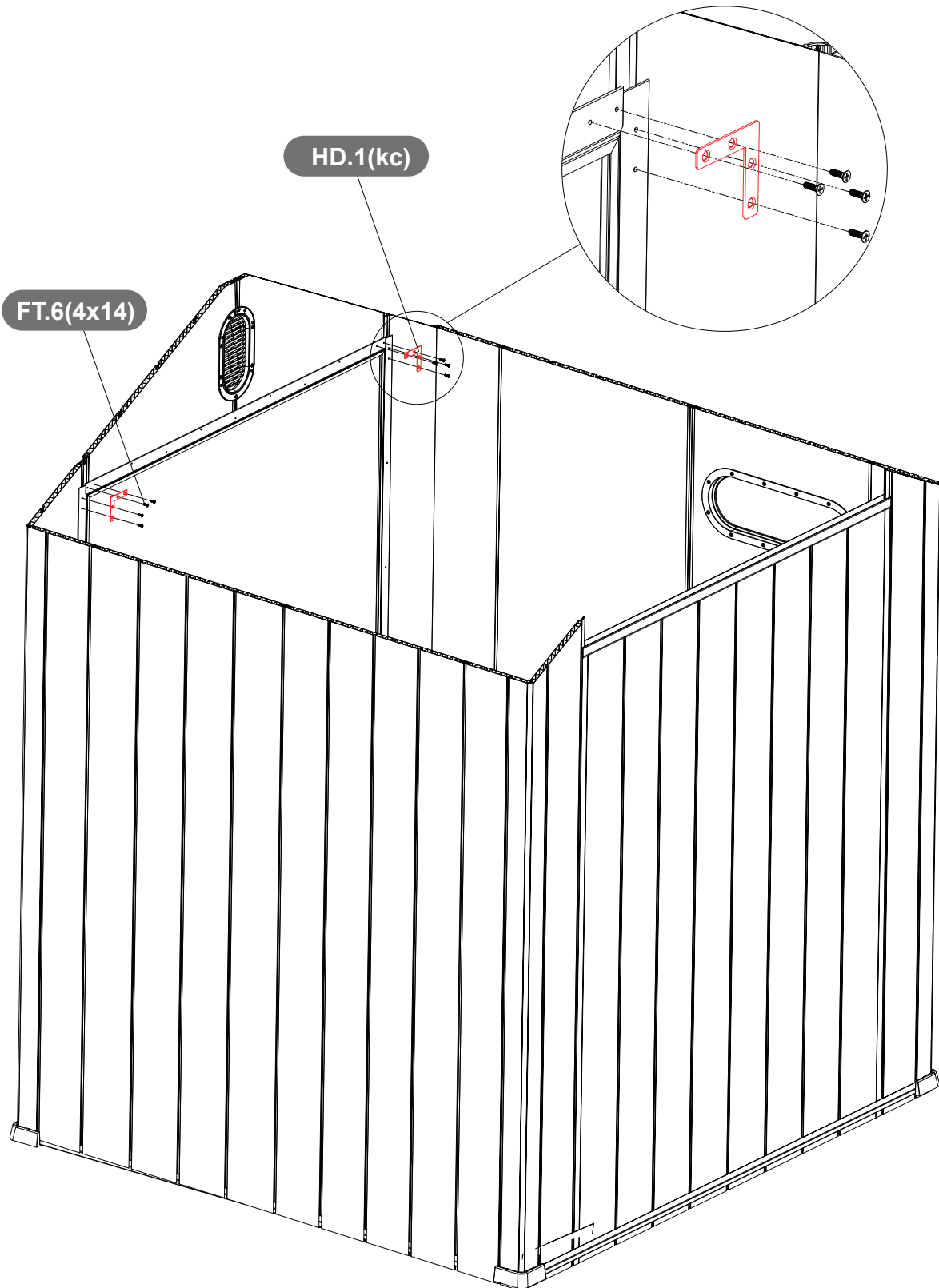

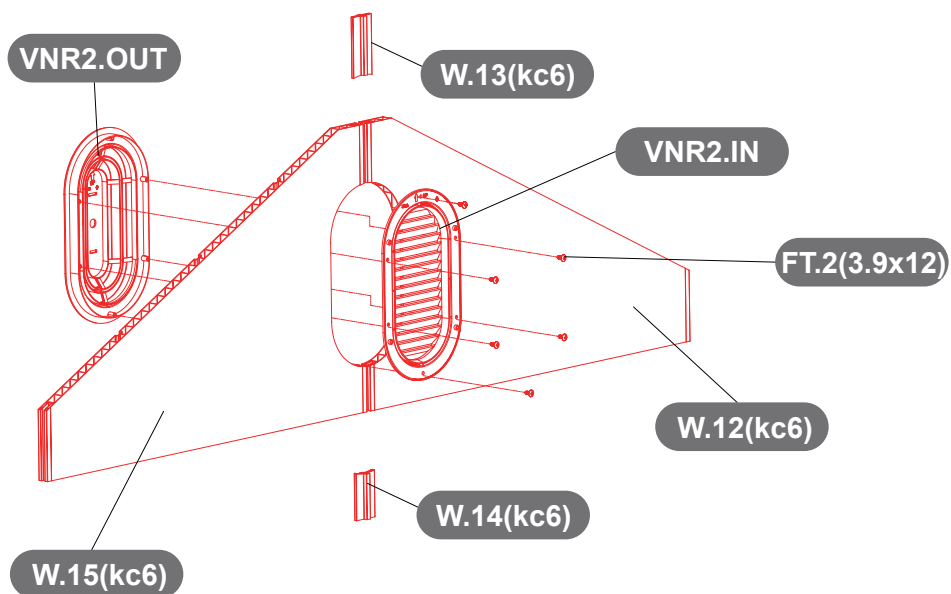

STEP 26

PART	NO	QTY
	HD.1(kc)	2
	FT.6(4x14)	8







STEP 27

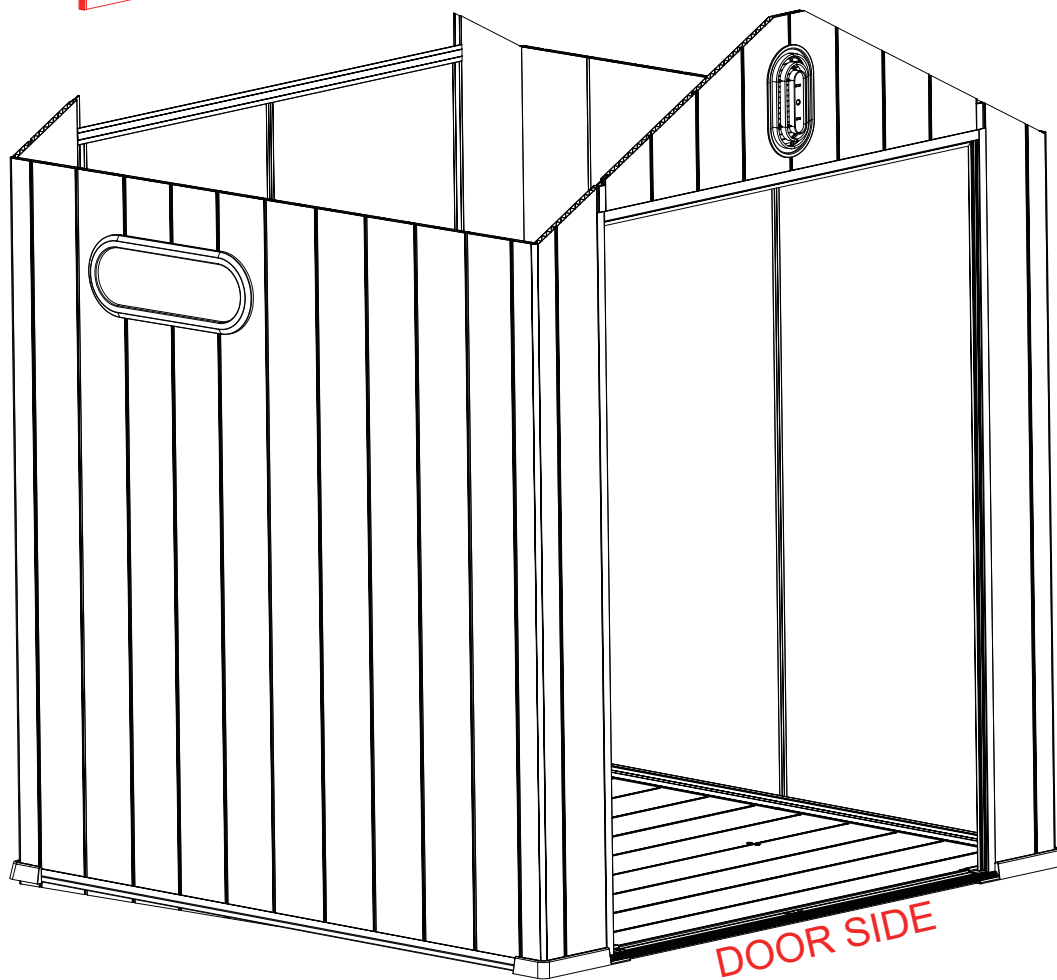
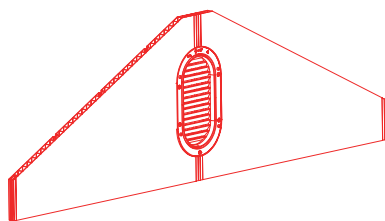

PART	NO	QTY
	VNR2.OUT	1
	VNR2.IN	1
	W.13(kc6)	1
	W.14(kc6)	1
	W.15(kc6)	1
	W.12(kc6)	1
	FT.2(3.9x12)	6
	W.10(kc)	1



STEP 28

PART	NO	QTY
	FR.6(kc)	2
	FR.7(kc46)	2
	FT.2(3.9x12)	18
	FT.8(M6X16)	4
	FT.7A(M6)	4

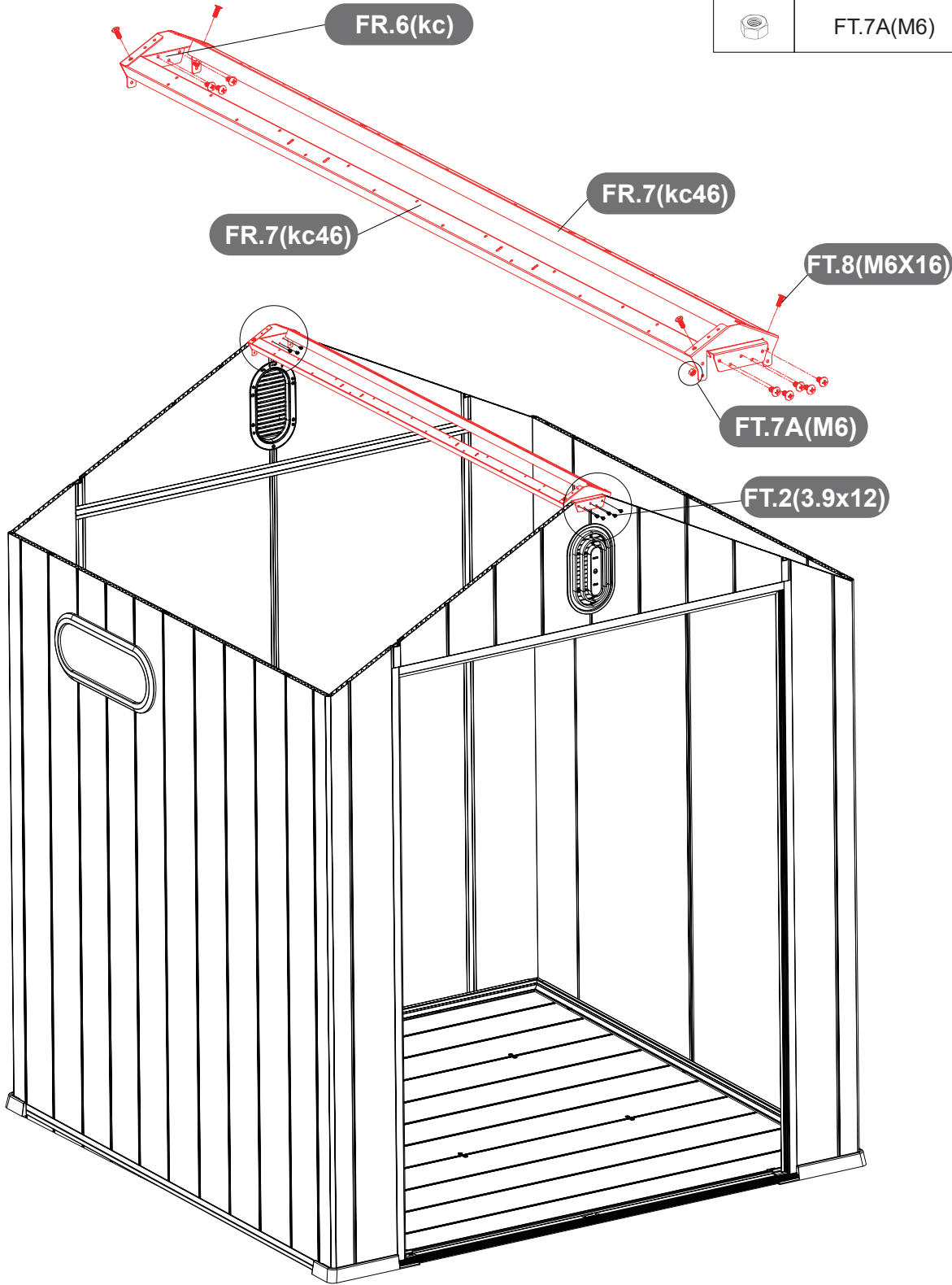

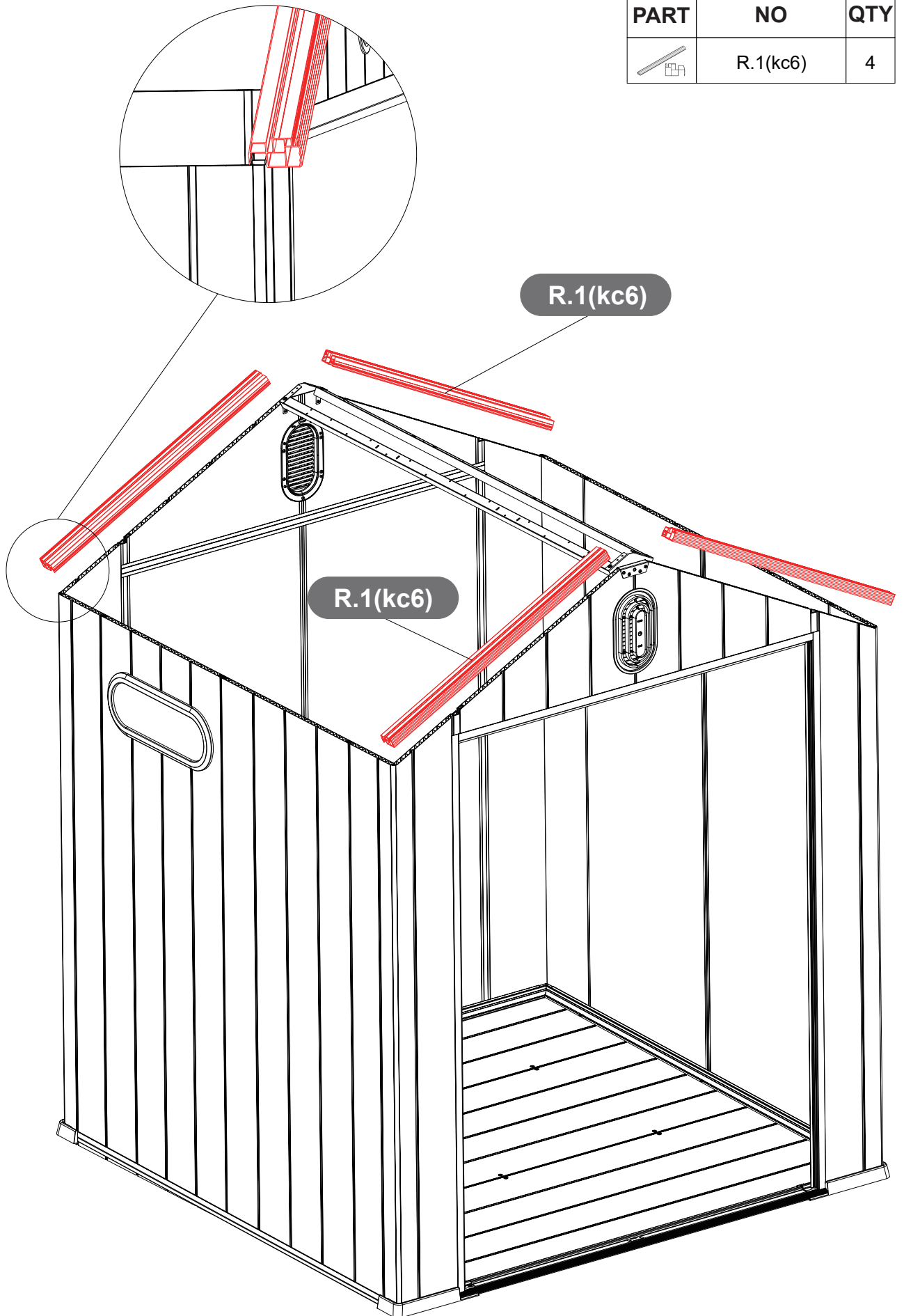

STEP 29

PART	NO	QTY
	R.1(kc6)	4



STEP 30

PART	NO	QTY
	R.2(kc46)	2
	R.5(kc6)	1
	R.6(kc6)	1

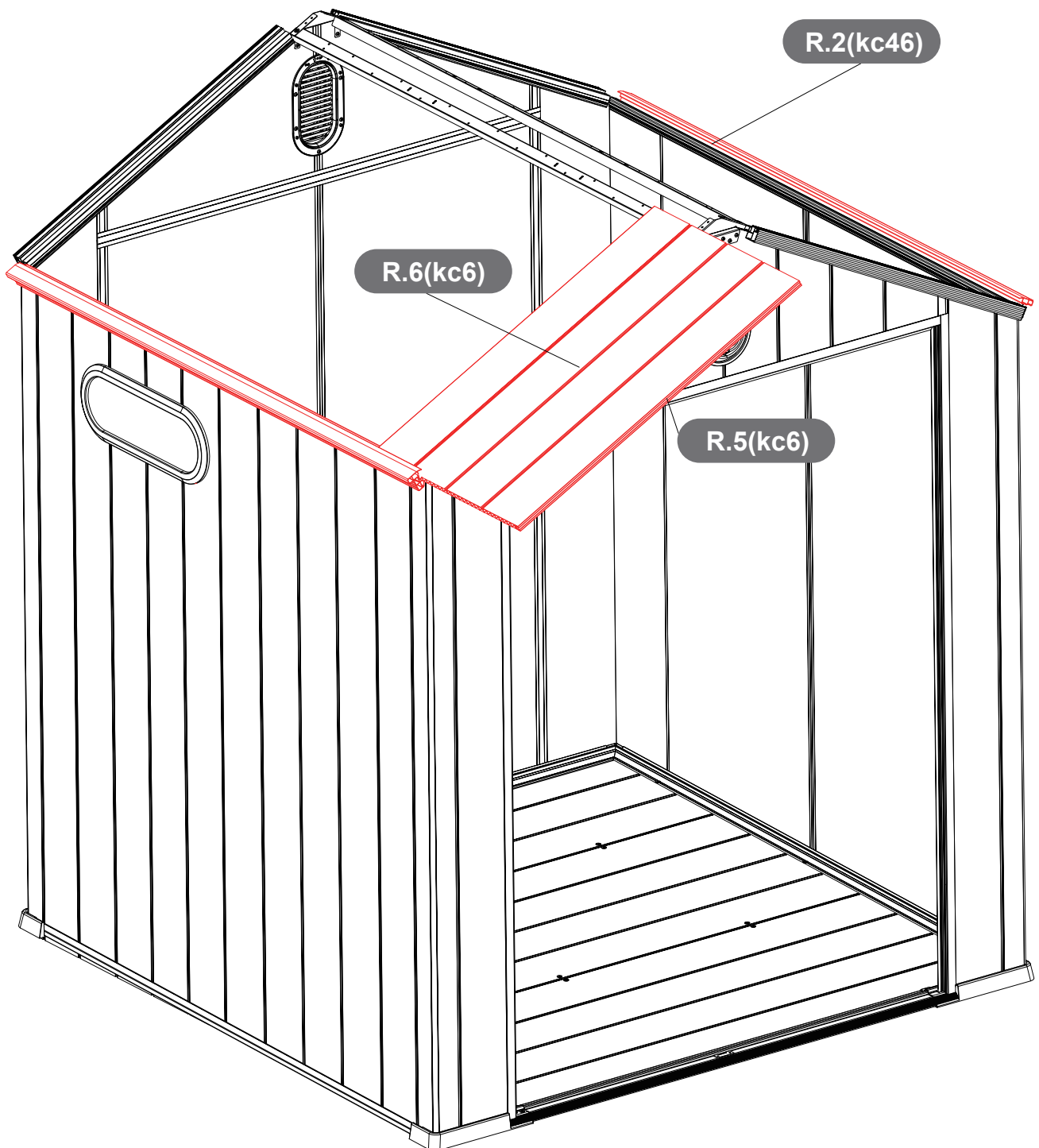

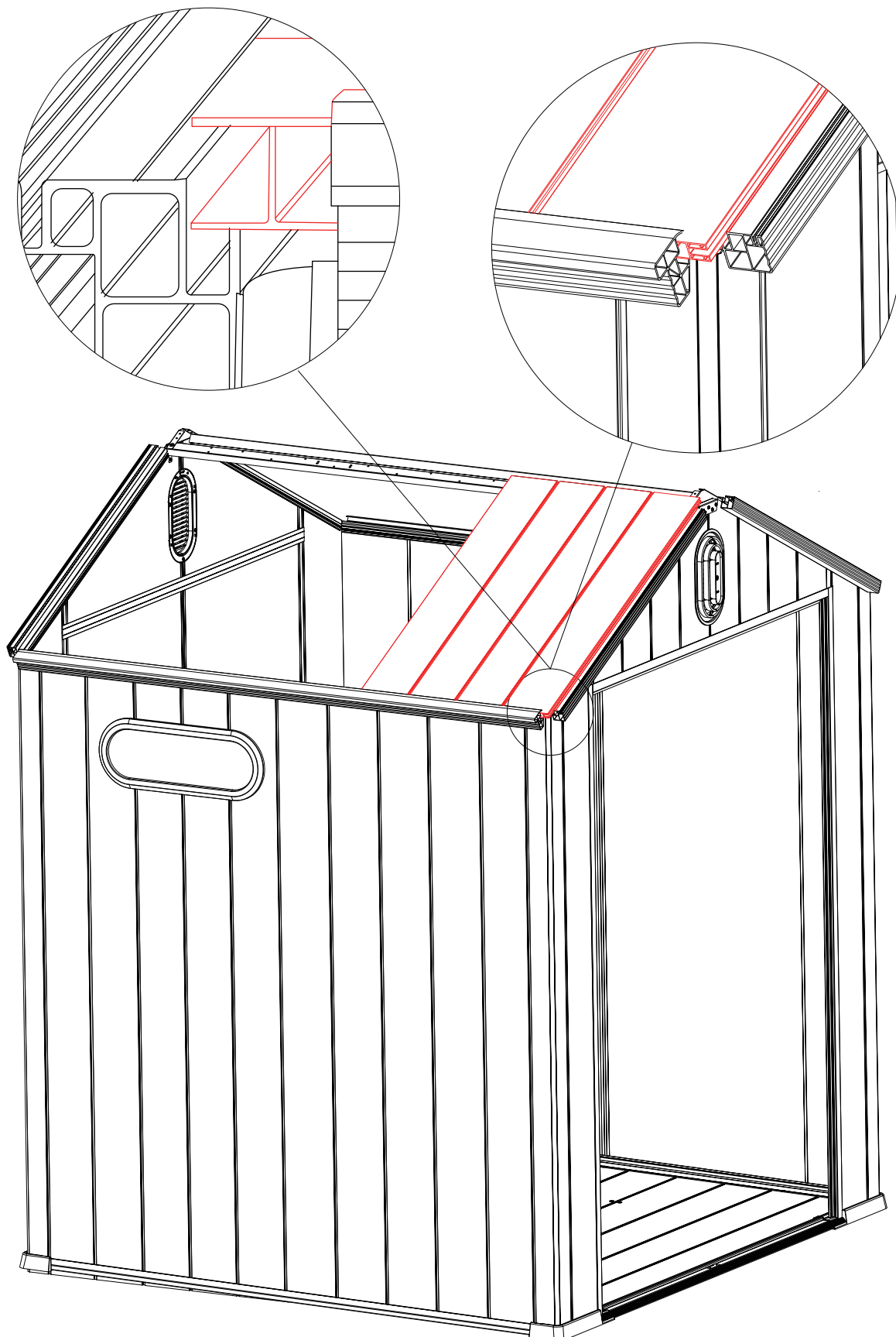

STEP 31

Note: R.6(kc6) is aligned with R.1(kc6), FR.7(kc46) edges.



STEP 32

PART	NO	QTY
	R.7(kc6)	1
	FT.3(3.9x30)	2

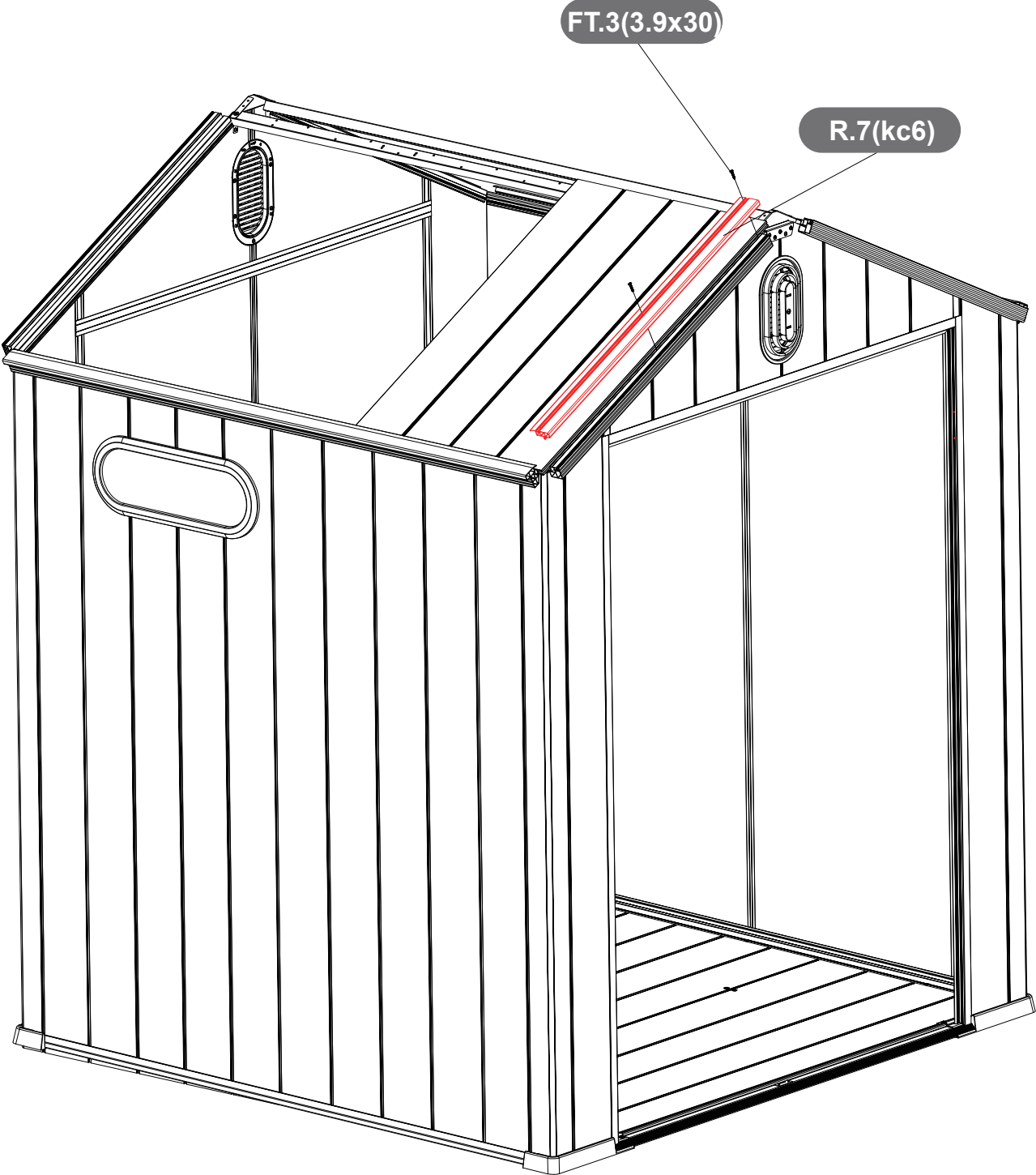

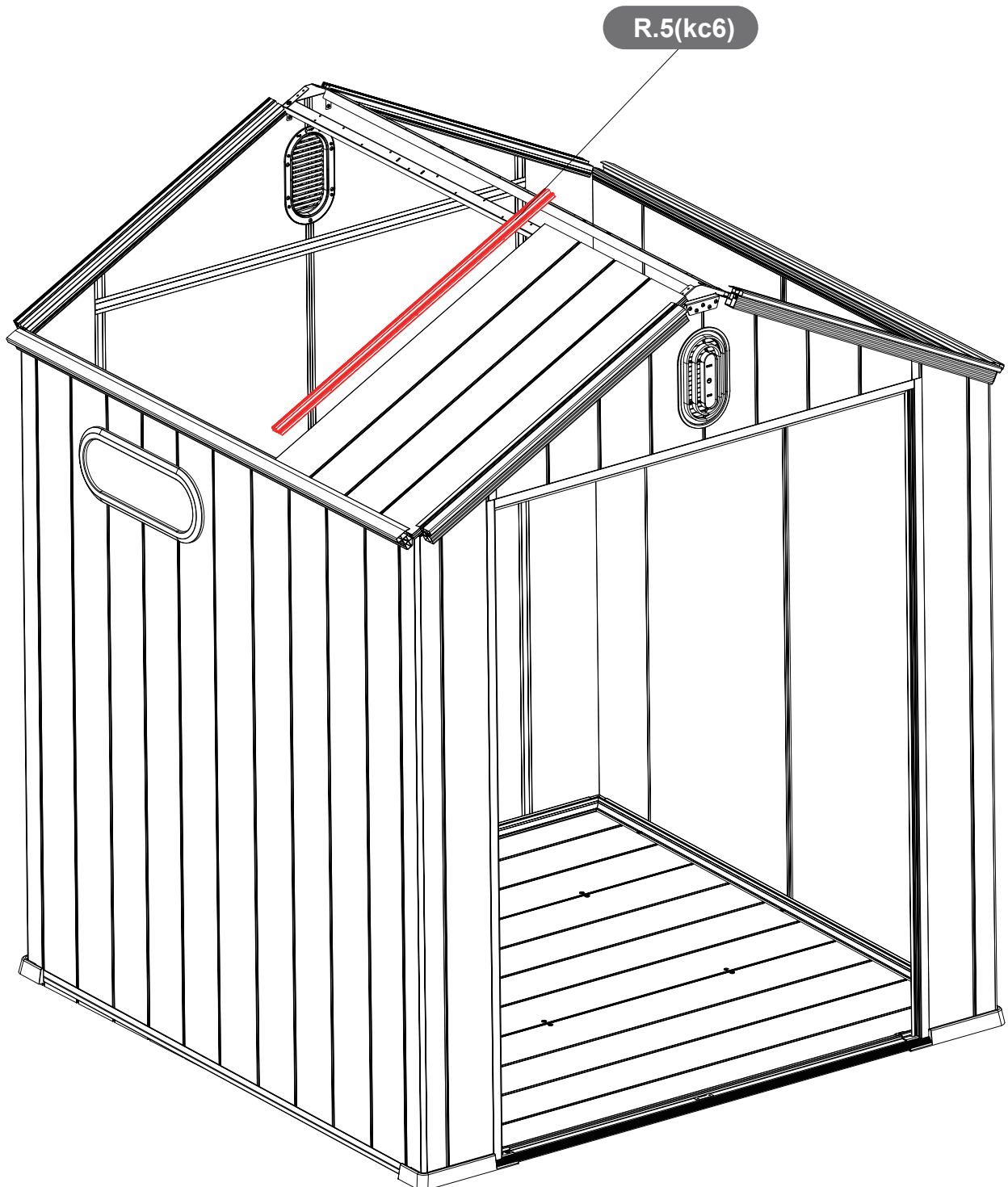

STEP 33

PART	NO	QTY
	R.5(kc6)	1



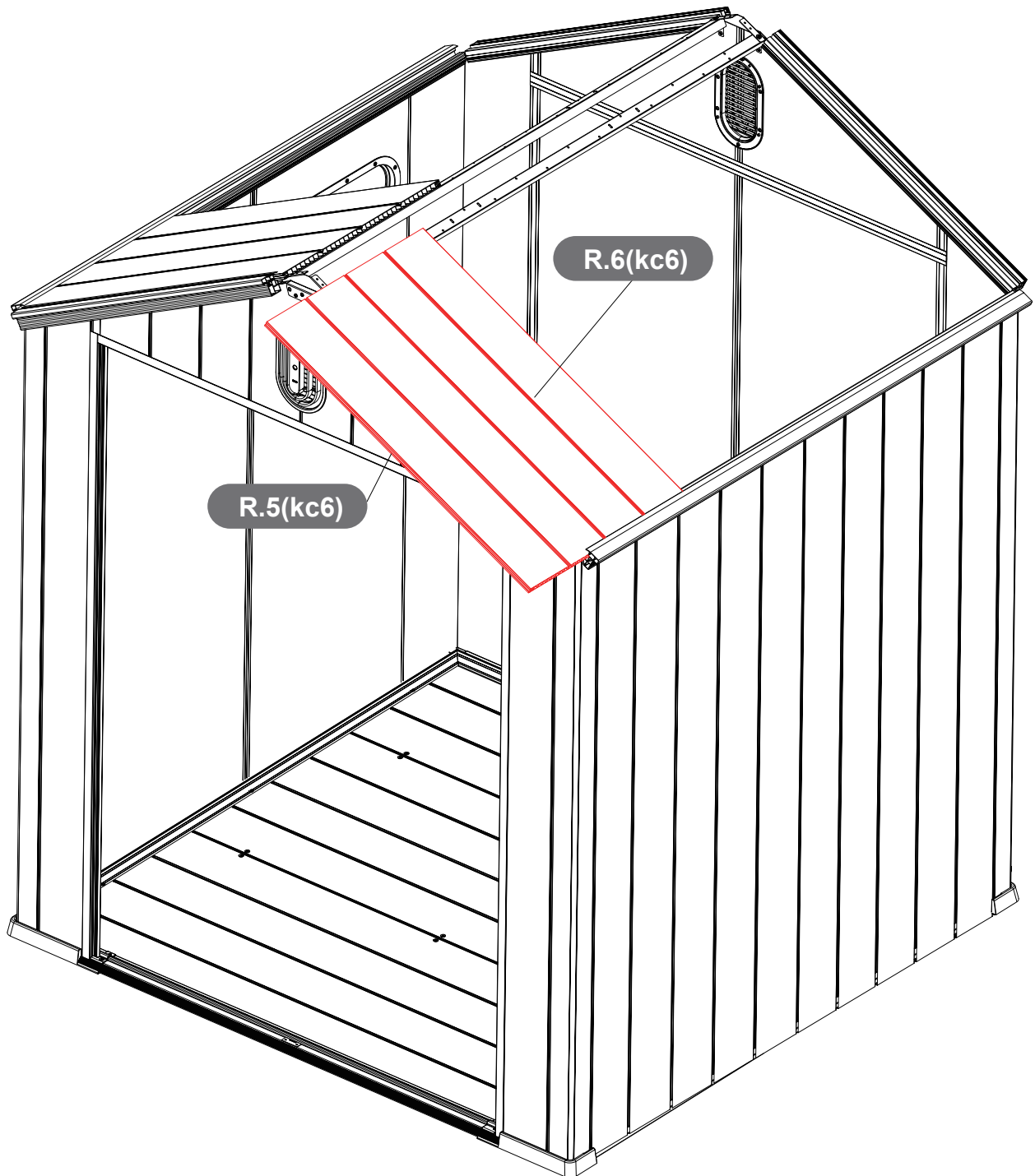

STEP 34

PART	NO	QTY
	R.5(kc6)	1
	R.6(kc6)	1



STEP 35

PART	NO	QTY
	R.7(kc6)	1
	FT.3(3.9x30)	2

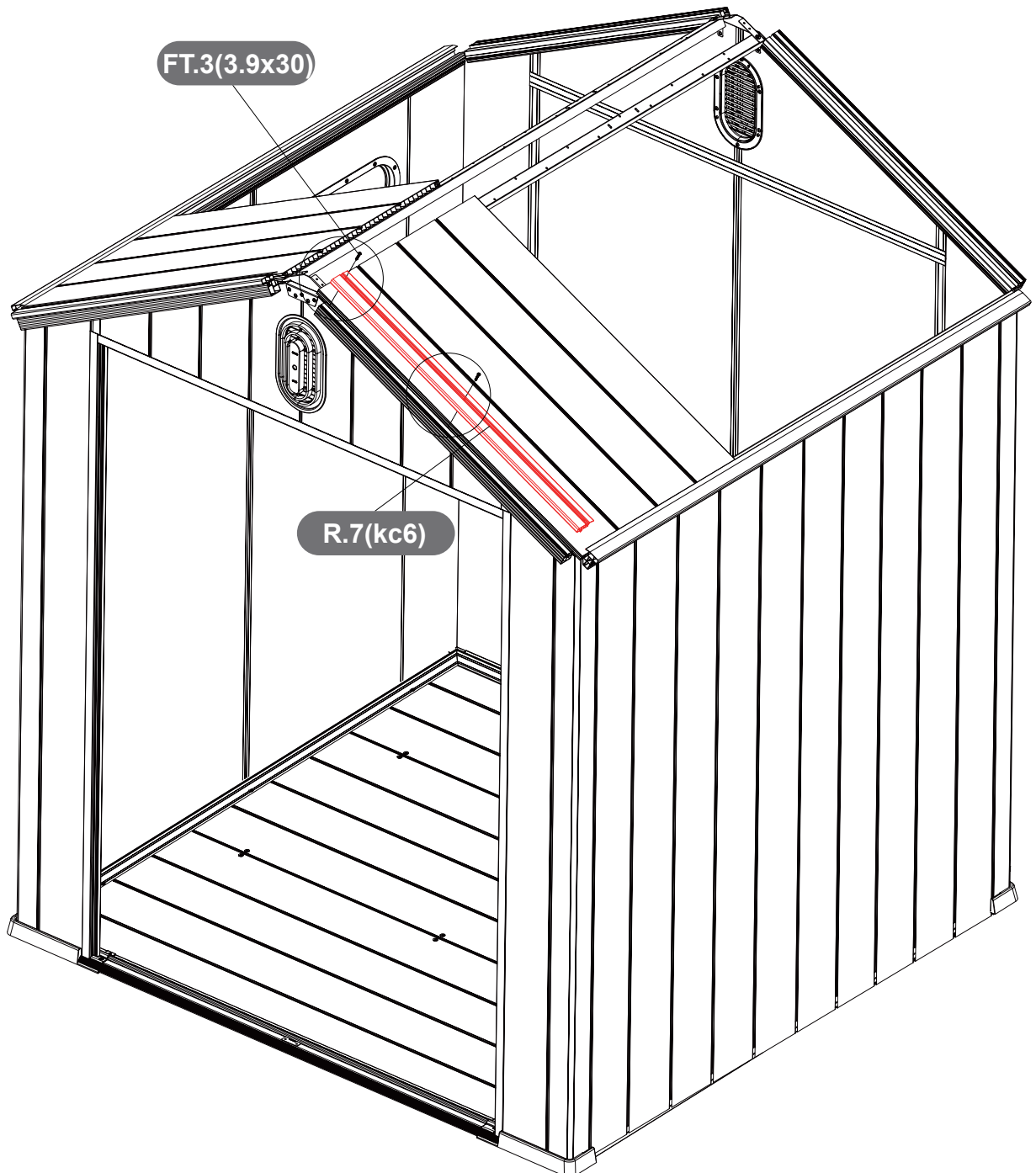

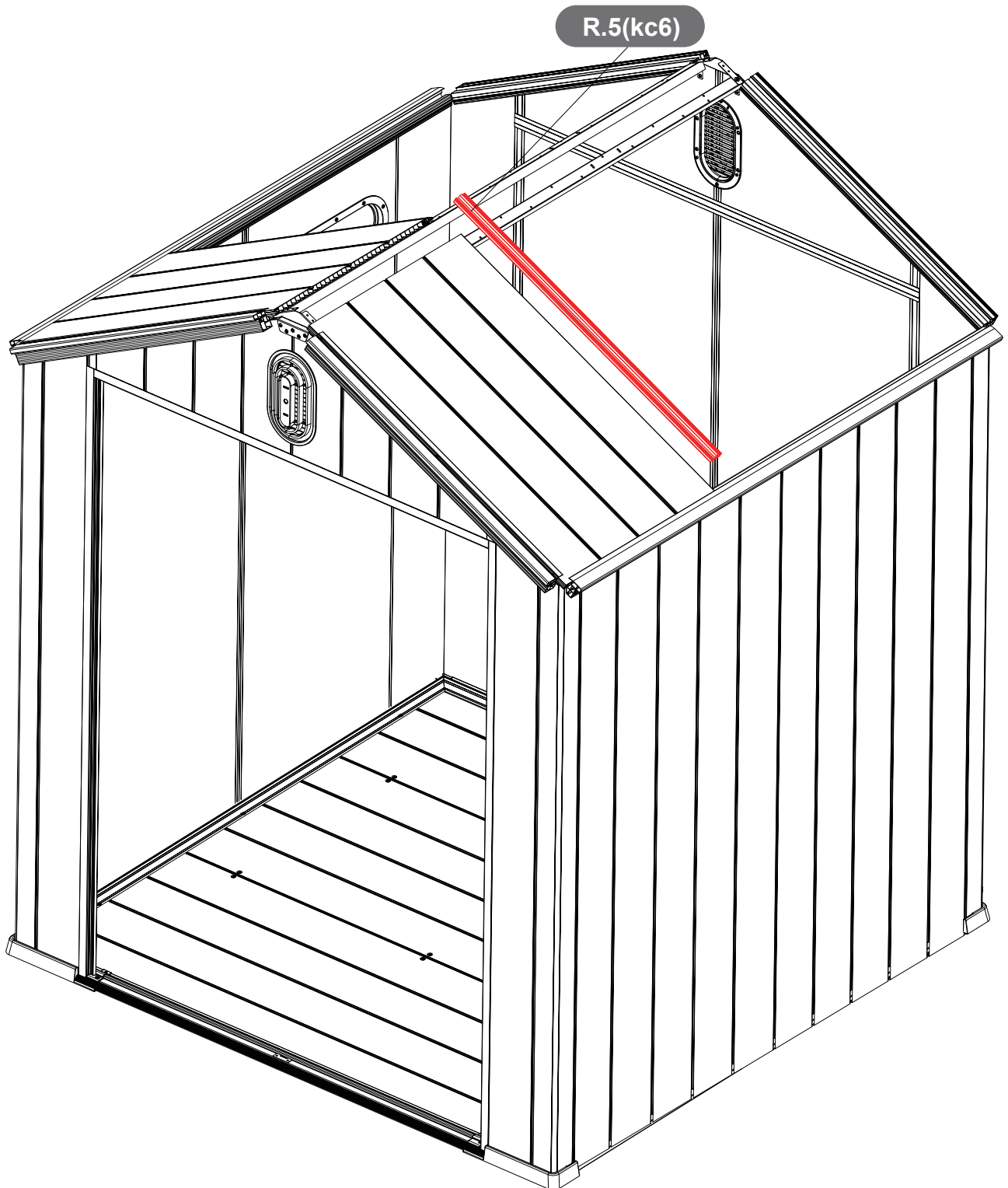

STEP 36

PART	NO	QTY
	R.5(kc6)	1



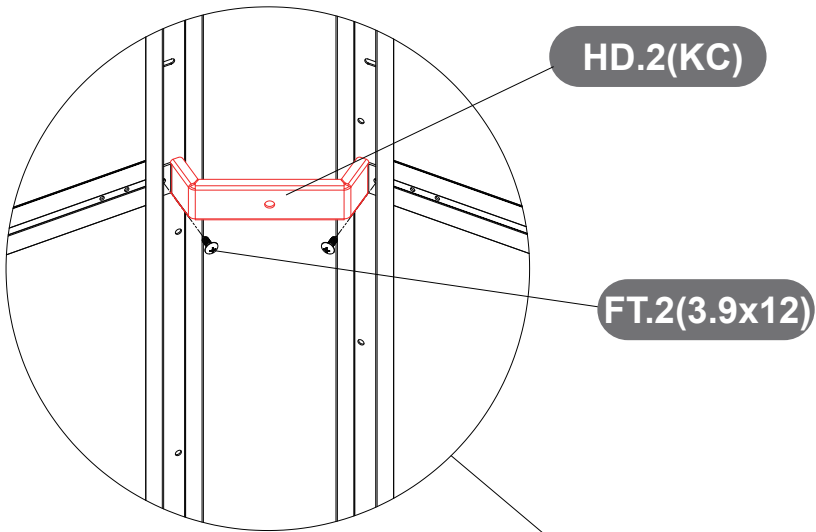

STEP 37

PART	NO	QTY
	HD.2(kc)	1
	FT.2(3.9x12)	2



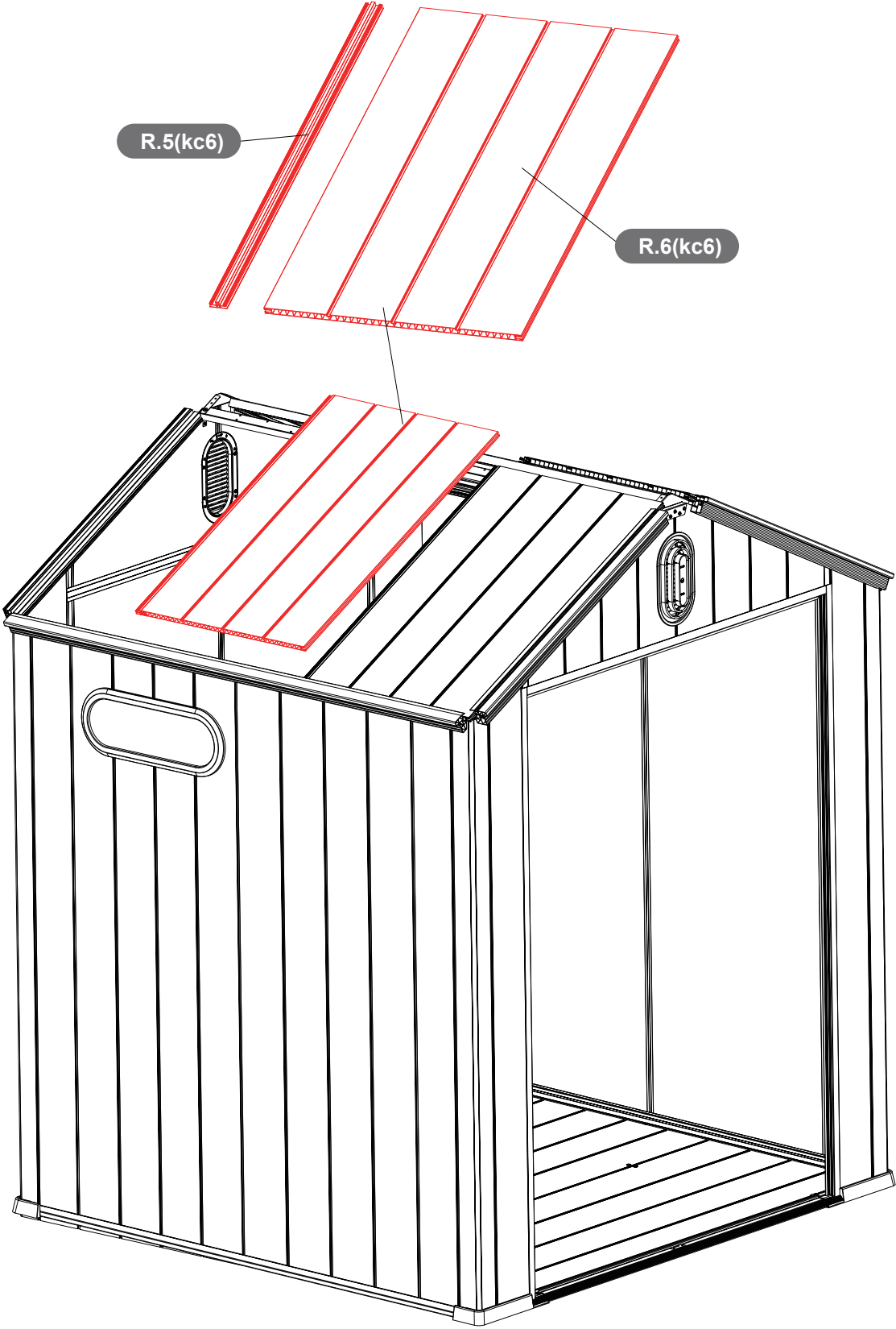

STEP 38

PART	NO	QTY
	R.5(kc6)	1
	R.6(kc6)	1



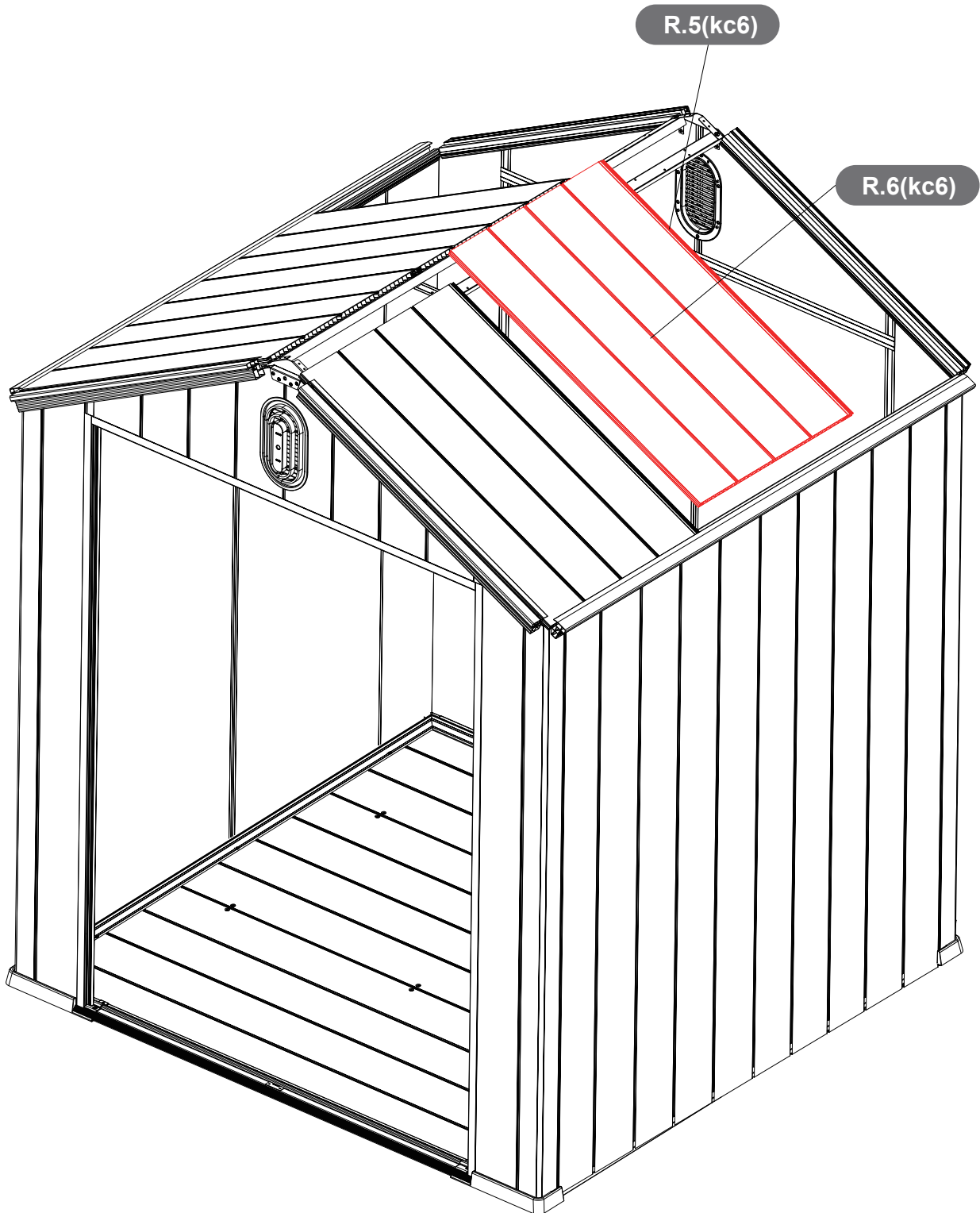

STEP 39

PART	NO	QTY
	R.5(kc6)	1
	R.6(kc6)	1



STEP 40

PART	NO	QTY
	HD.2(kc)	1
	FT.2(3.9x12)	2

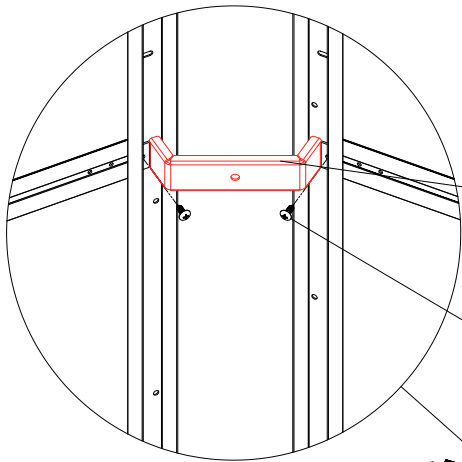

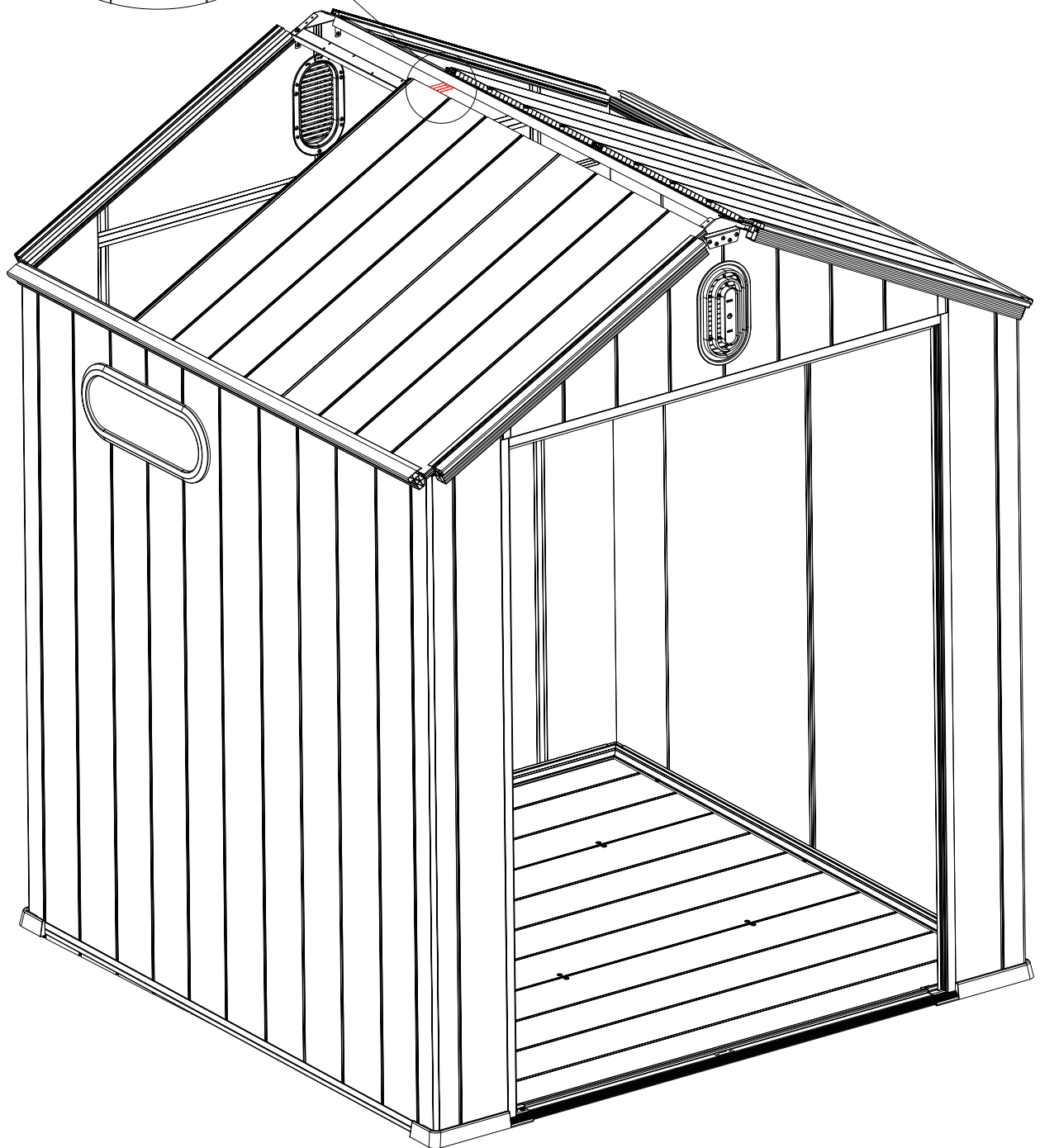

HD.2(KC)

FT.2(3.9x12)



STEP 41

NOTE: Lock the screws after the top plate is flush with FR.7(KC46).

PART	NO	QTY
	FR.7(kc46)	1
	R.6(kc6)	1

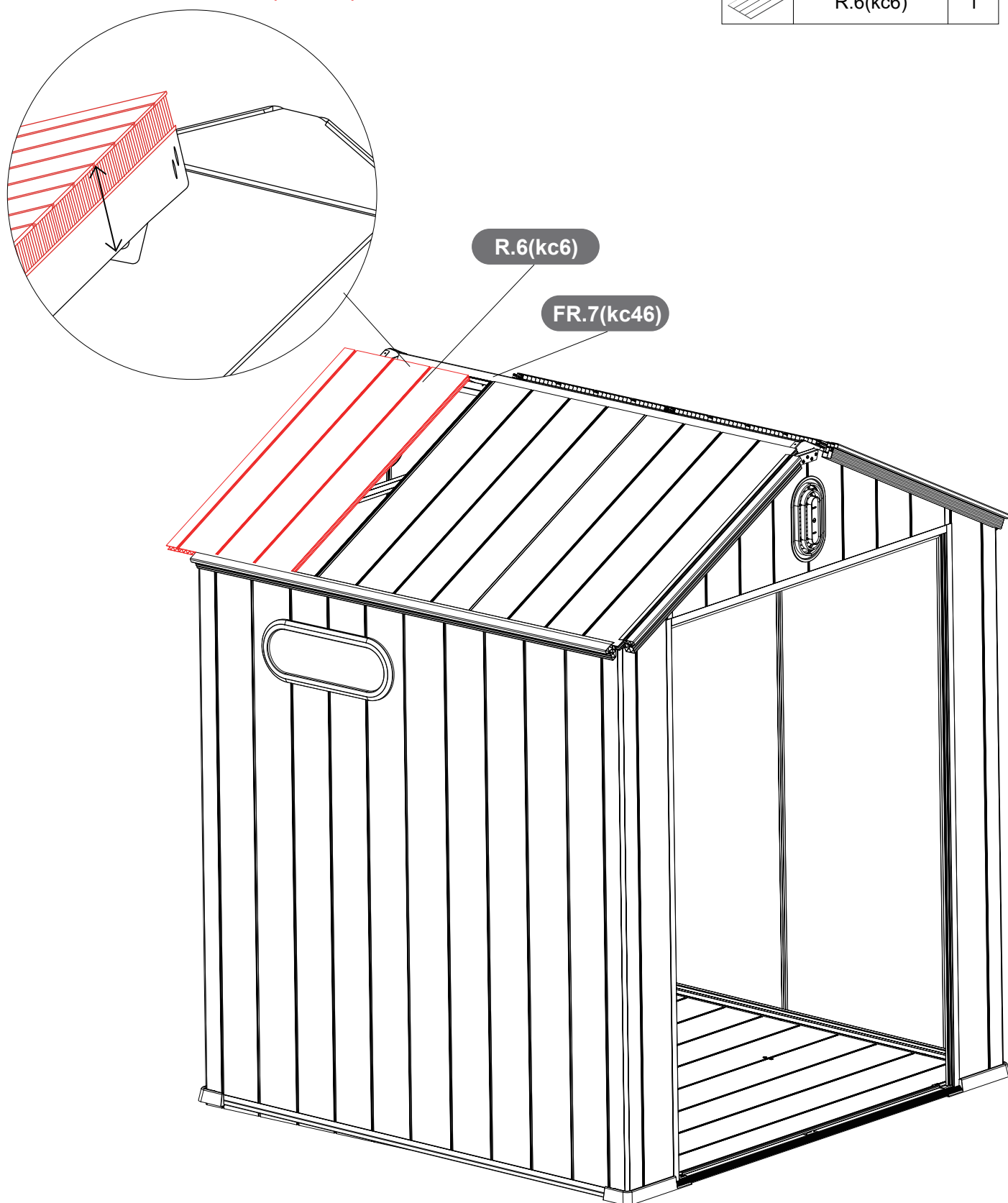

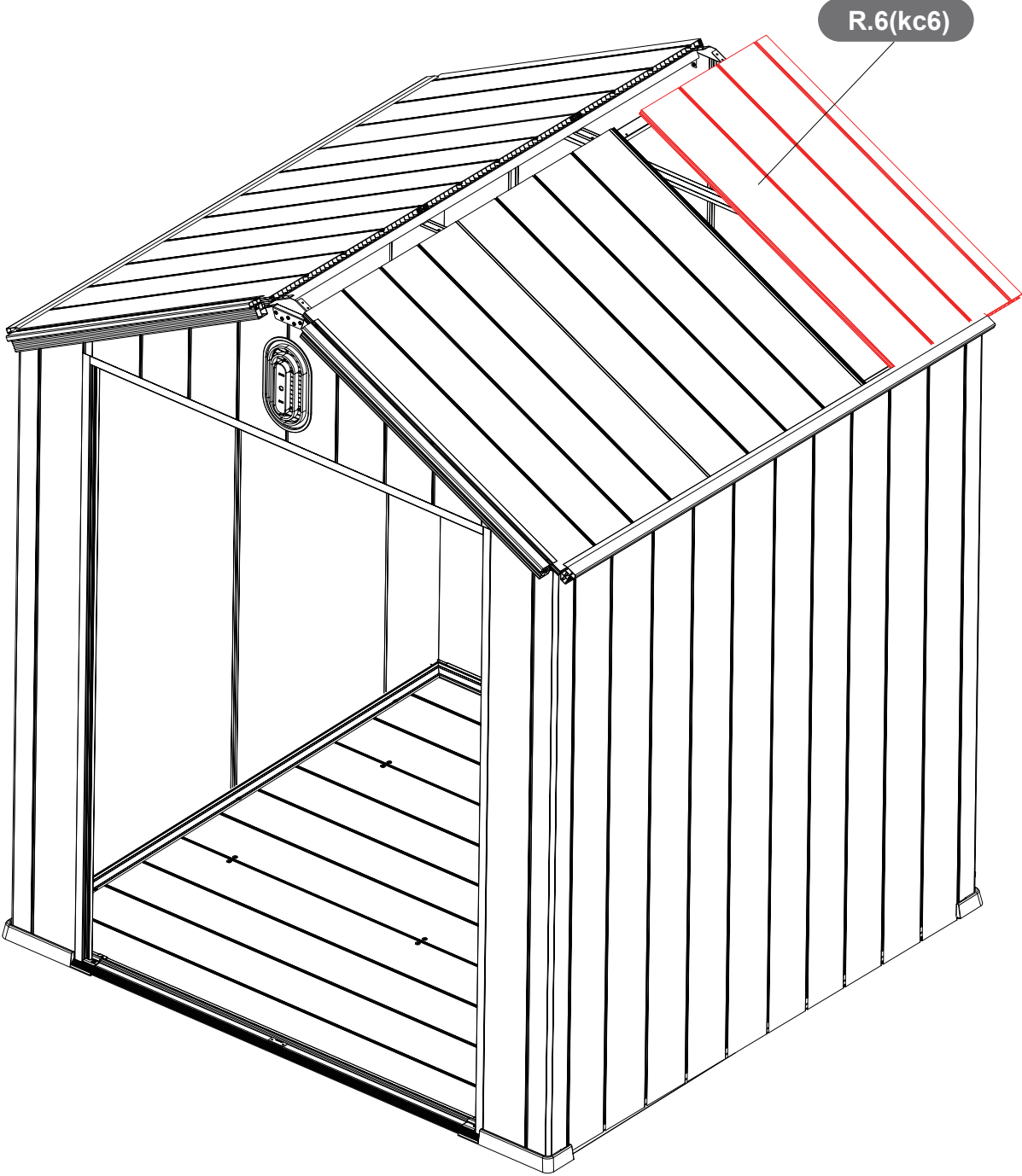

STEP 42

PART	NO	QTY
	R.6(kc6)	1



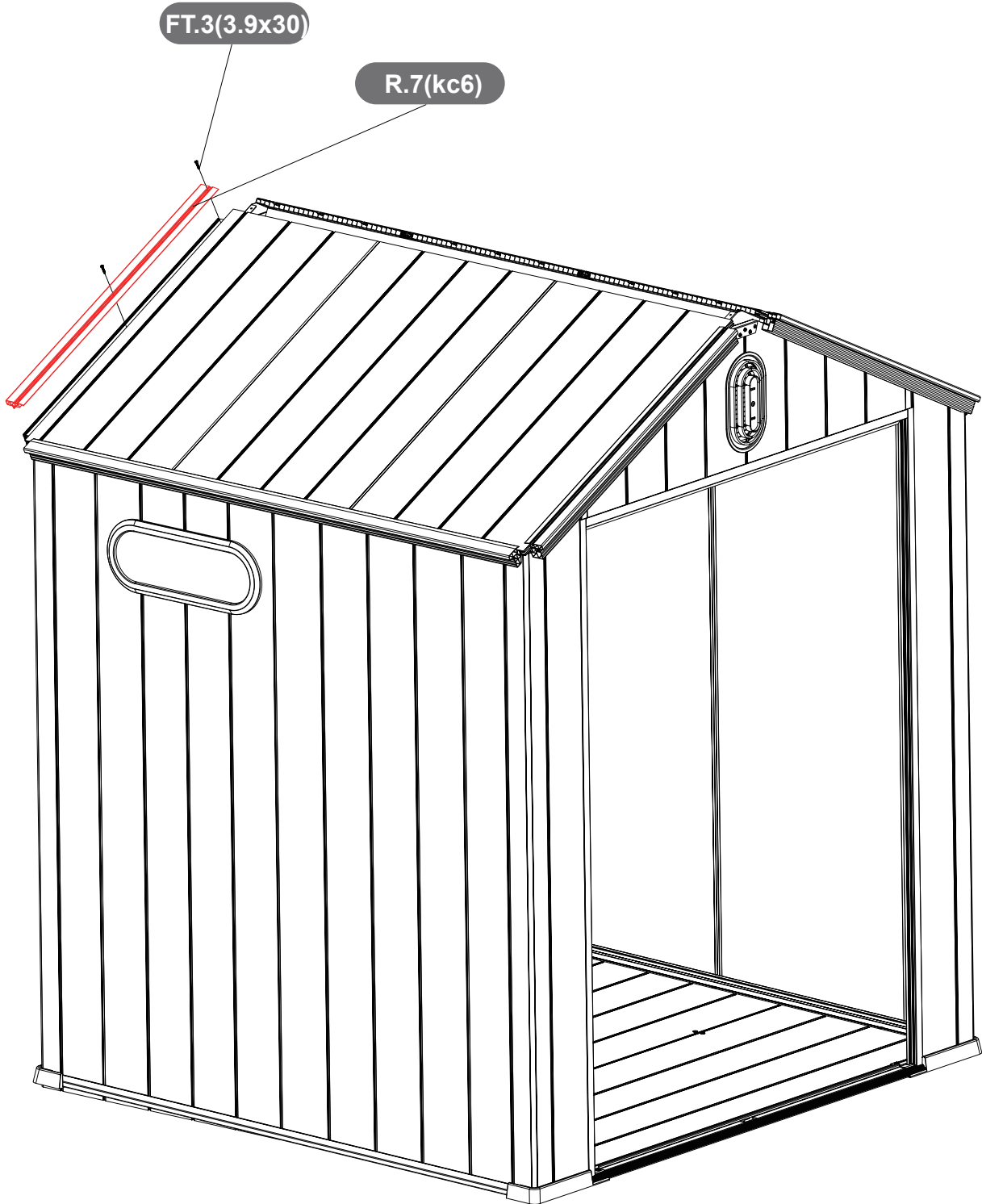

STEP 43

PART	NO	QTY
	R.7(kc6)	1
	FT.3(3.9x30)	2



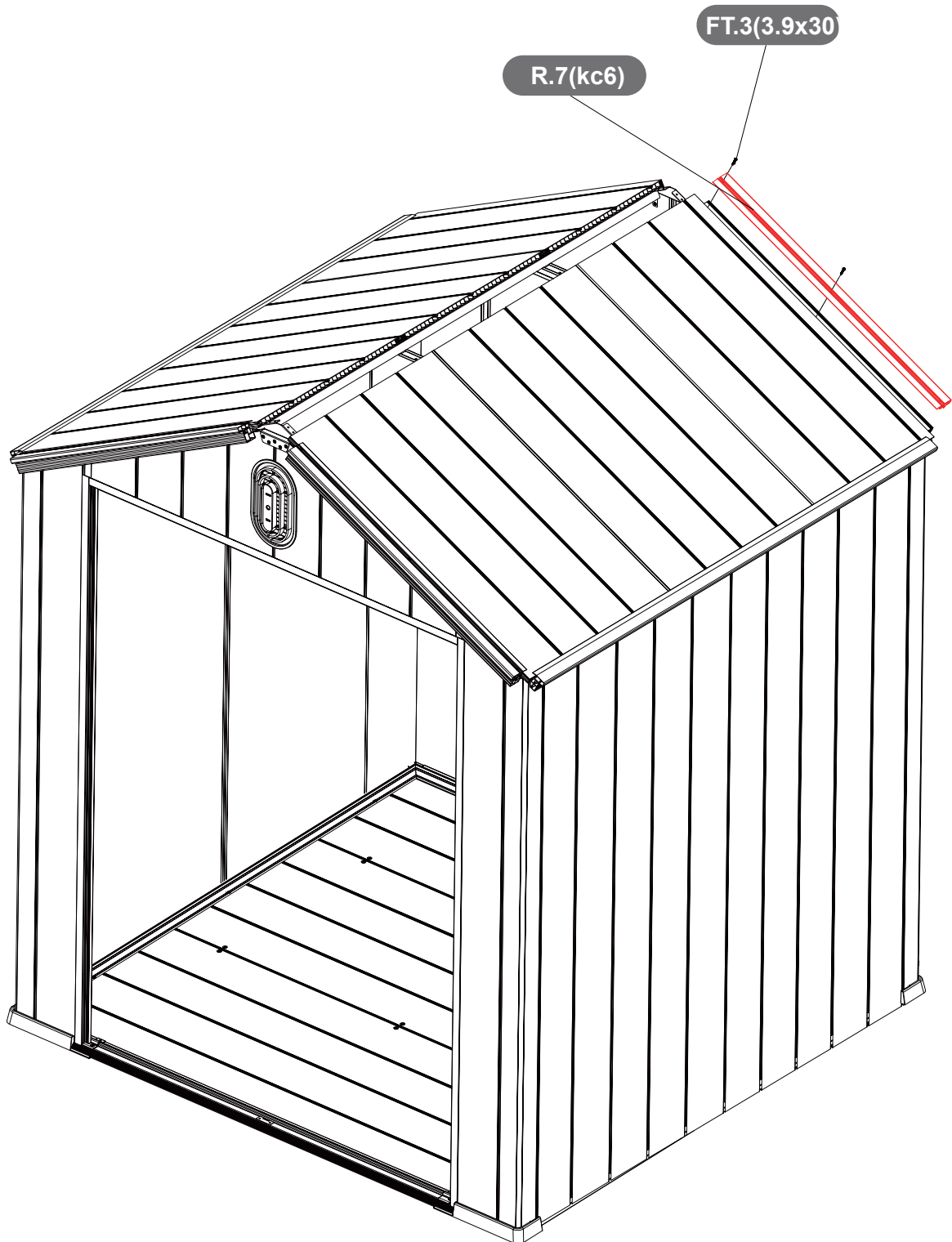

STEP 44

PART	NO	QTY
	R.7(kc6)	1
	FT.3(3.9x30)	2





STEP 45

NOTE: Attach rubber sealing strips to both ends of R.8(kc46) and be careful when pushing.

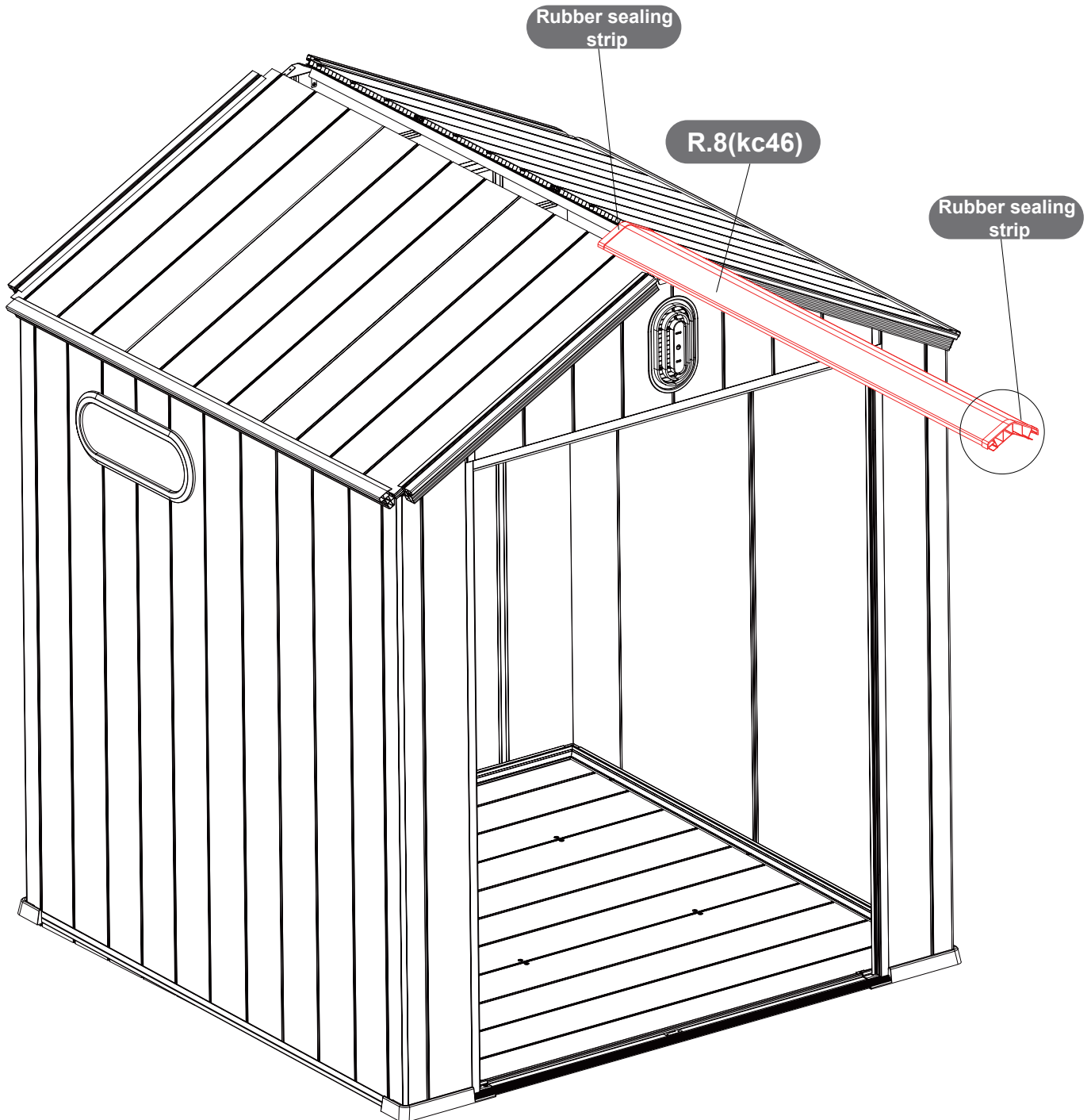
PART	NO	QTY
	R.8(kc46)	1
	Rubber sealing strip	2



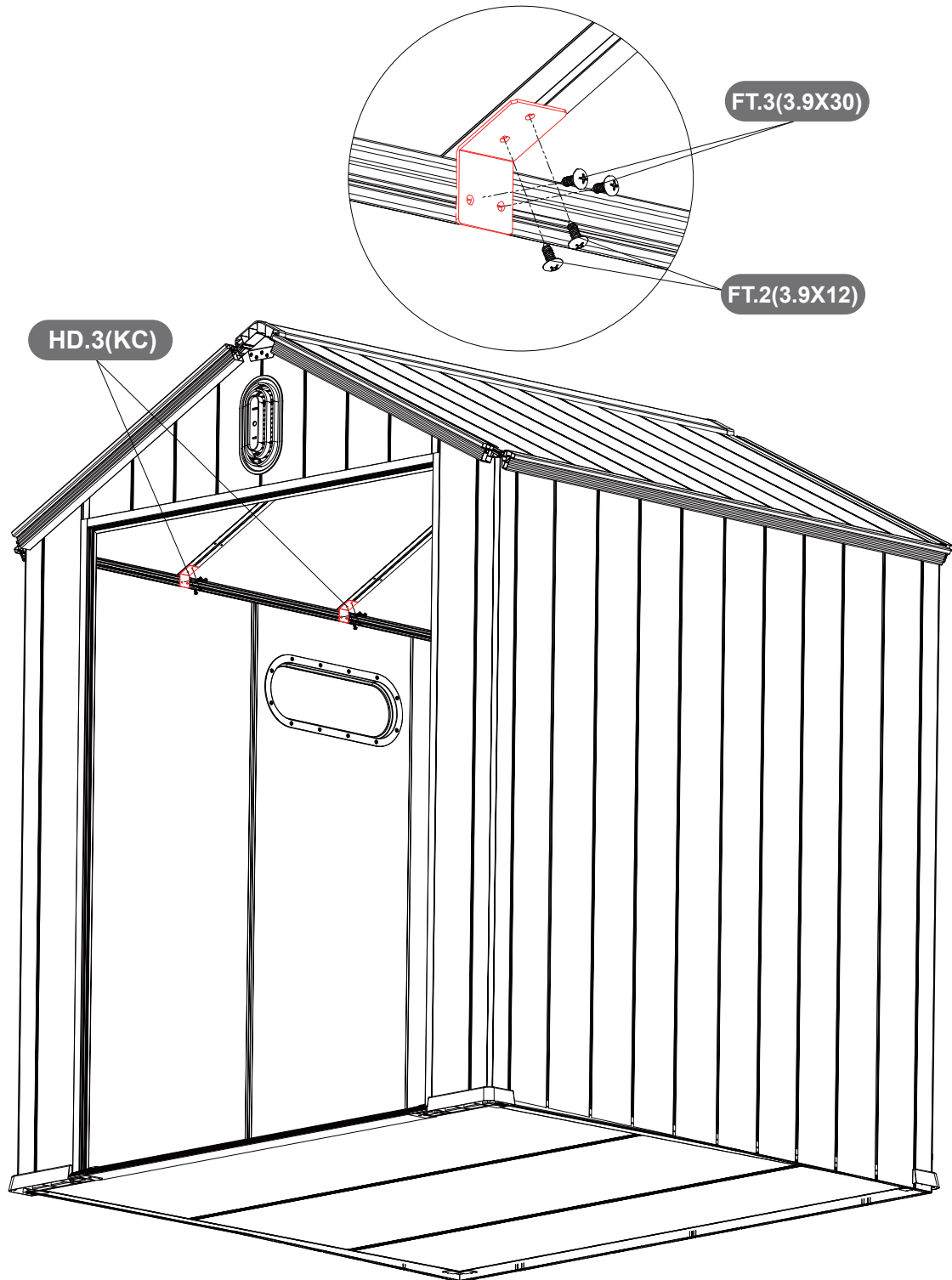

STEP 46

PART	NO	QTY
	HD.3(kc)	2
	FT.2(3.9x12)	4
	FT.3(3.9x30)	4



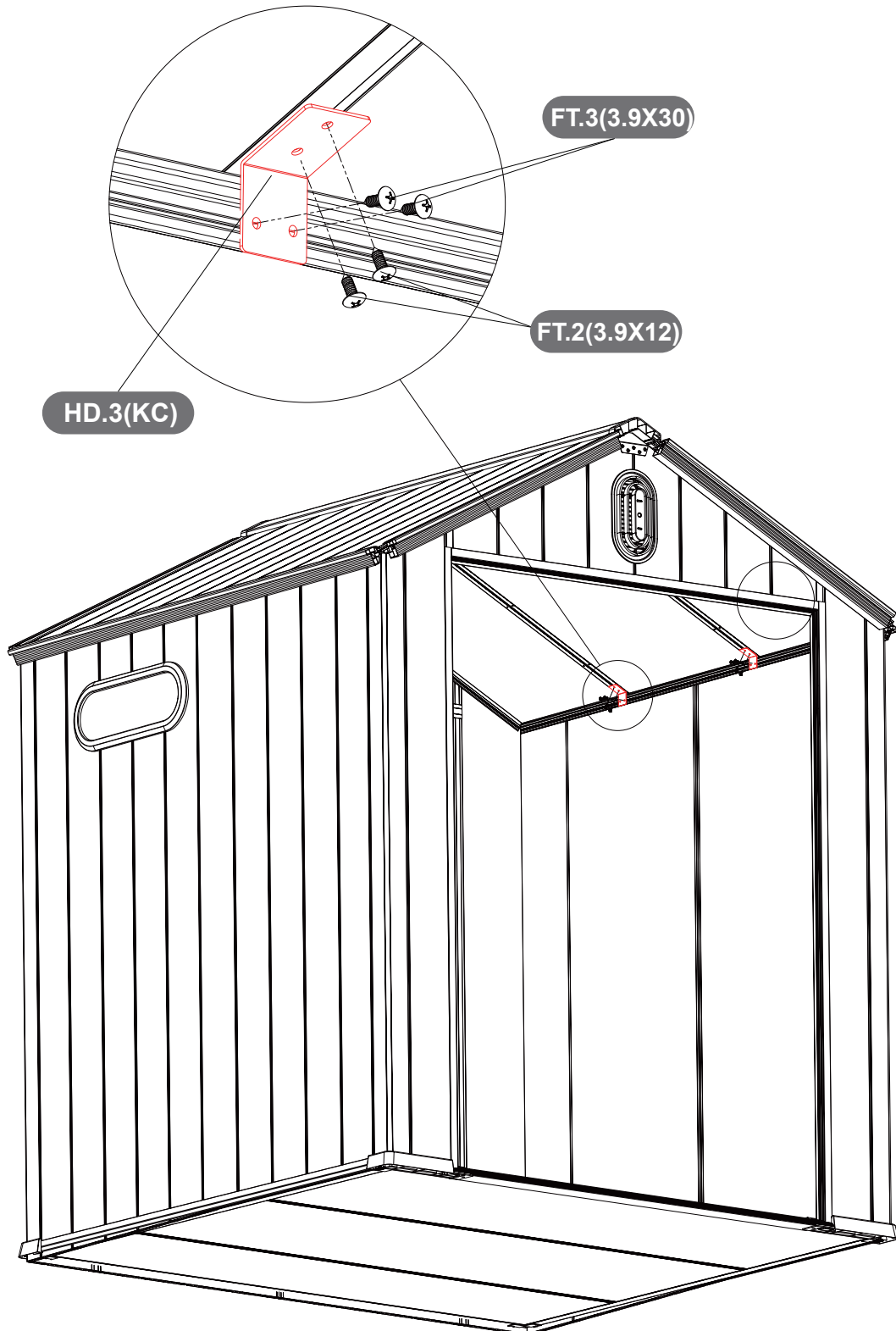

STEP 47

PART	NO	QTY
	HD.3(kc)	2
	FT.2(3.9x12)	4
	FT.3(3.9x30)	4



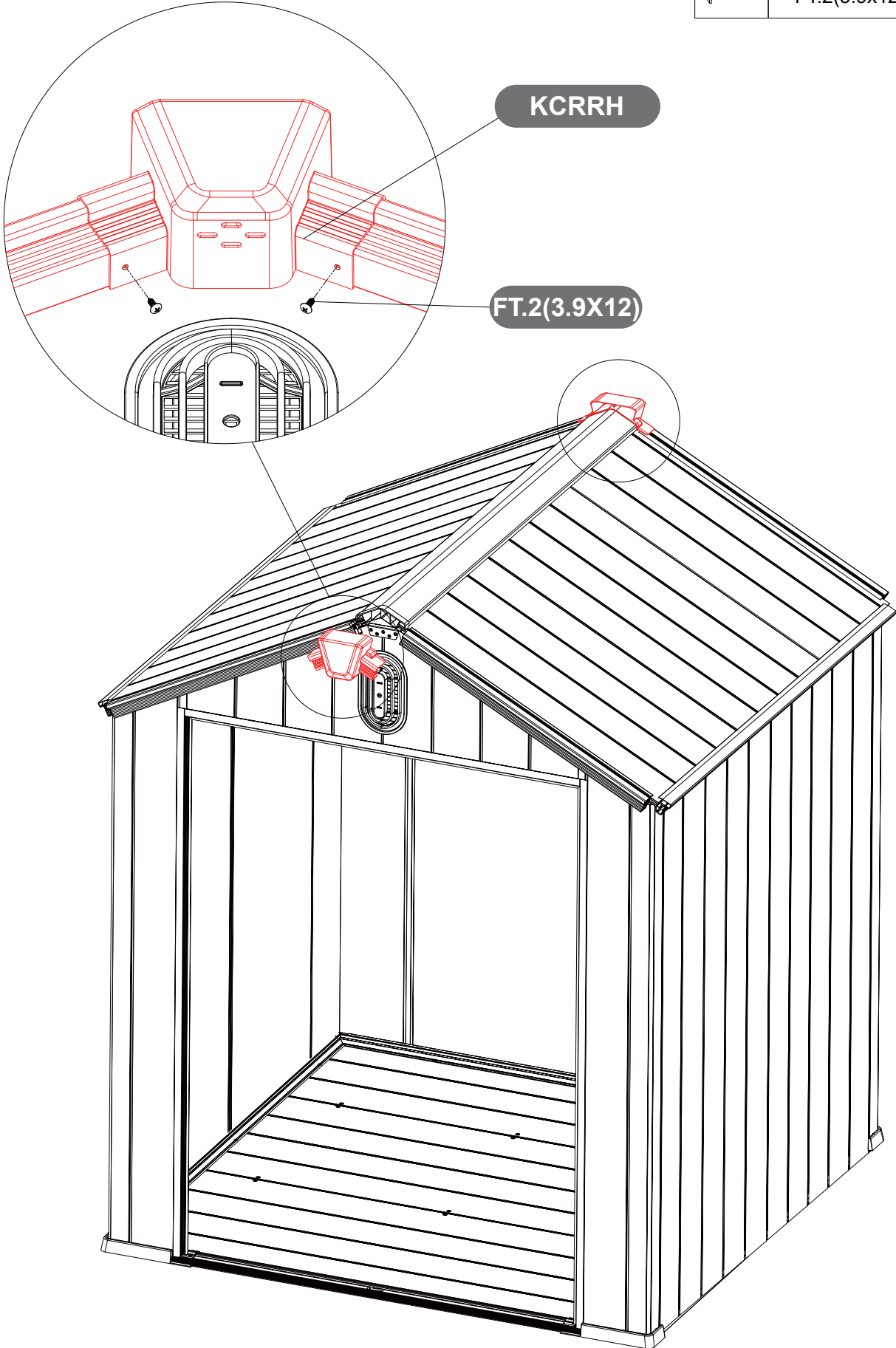

STEP 48

PART	NO	QTY
	KCRRH	2
	FT.2(3.9x12)	4







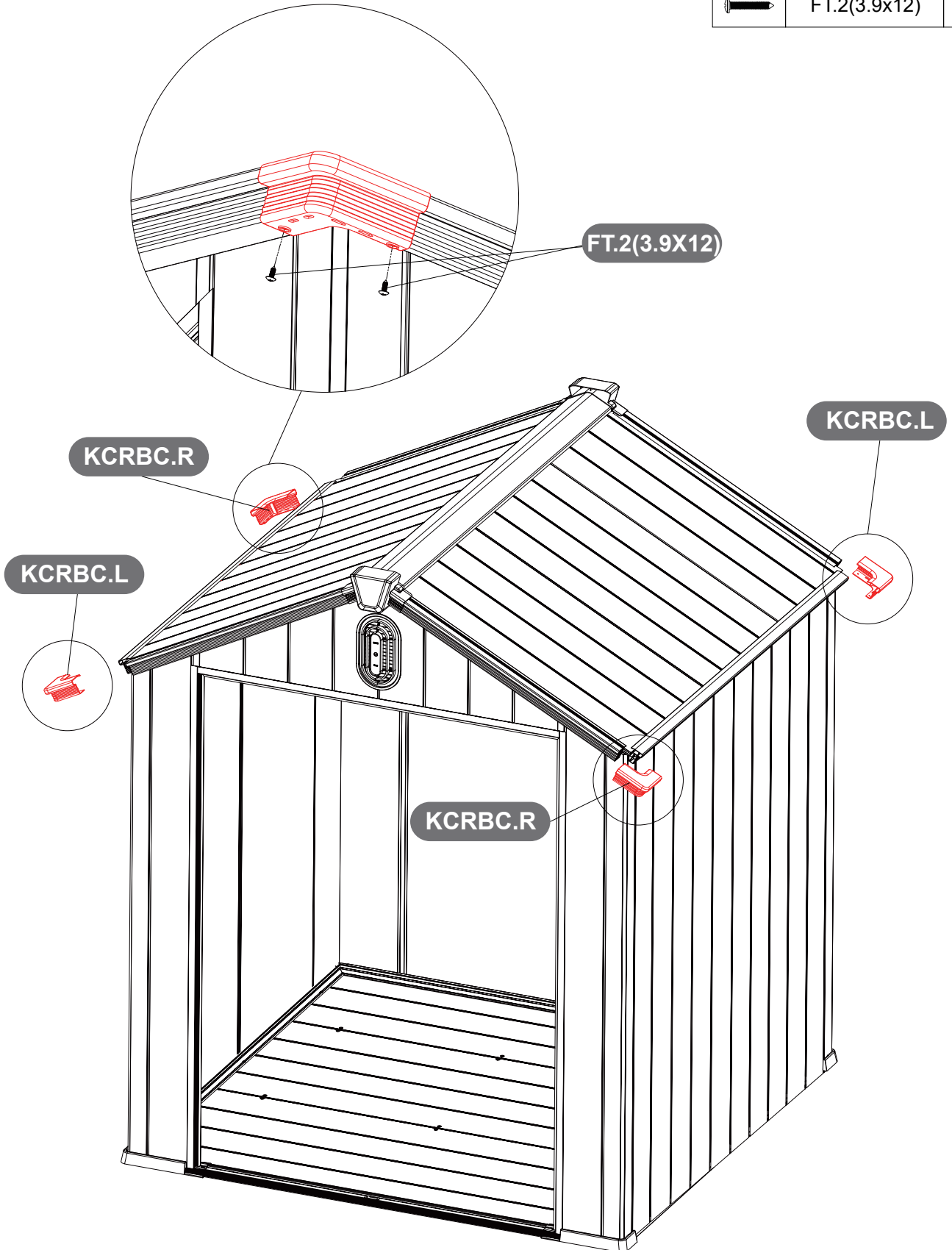

STEP 49

PART	NO	QTY
	KCRBC.L	2
	KCRBC.R	2
	FT.2(3.9x12)	8



STEP 50

PART	NO	QTY
	FR.4(kc6)	2
	FR.11(kc)	1
	FT.7(M6X40)	4
	FT.7A(M6)	4
	FR.14(kc)	1
	FT.2(3.9x12)	24

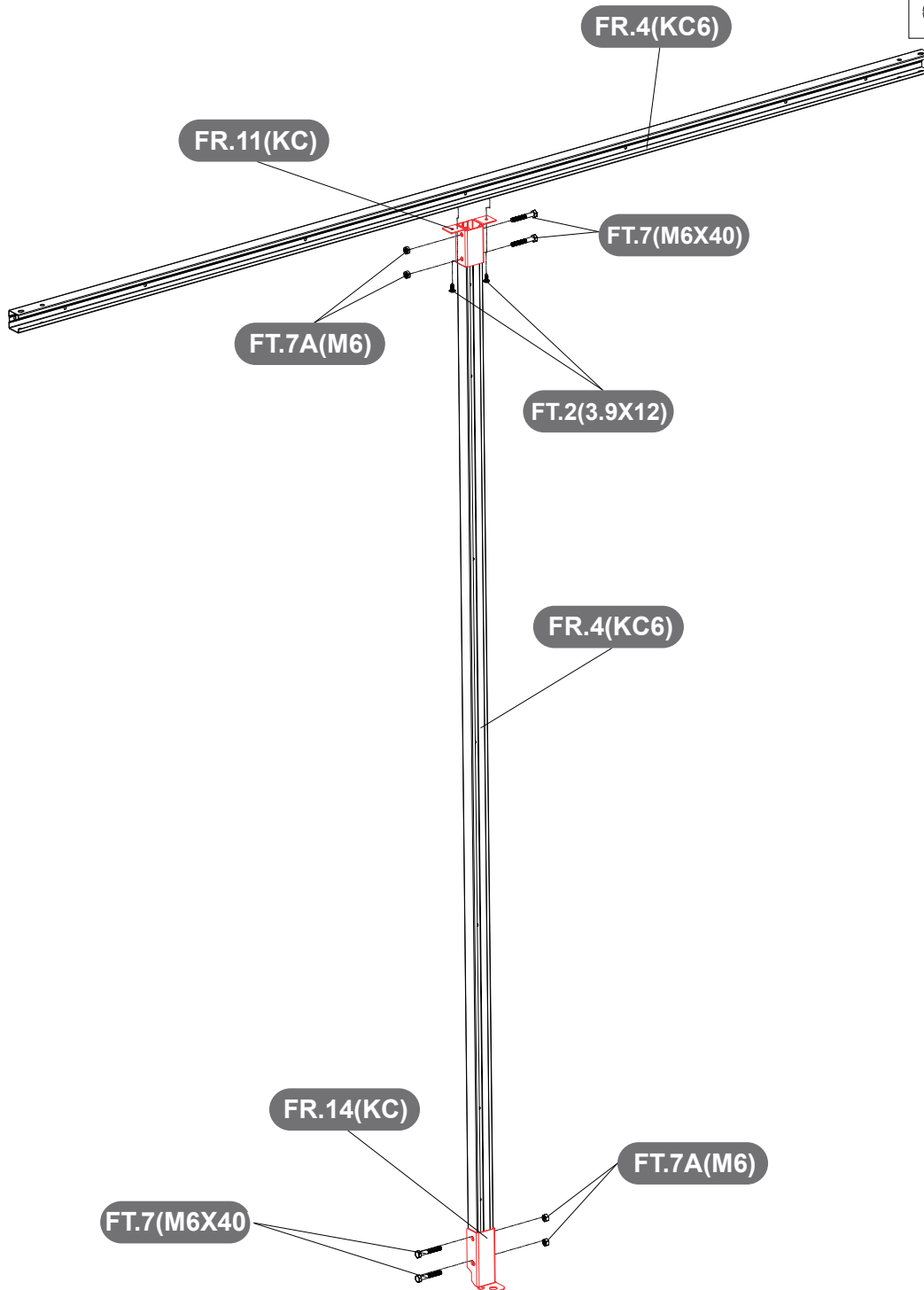

STEP 51

PART	NO	QTY
	FT.2(3.9x12)	7

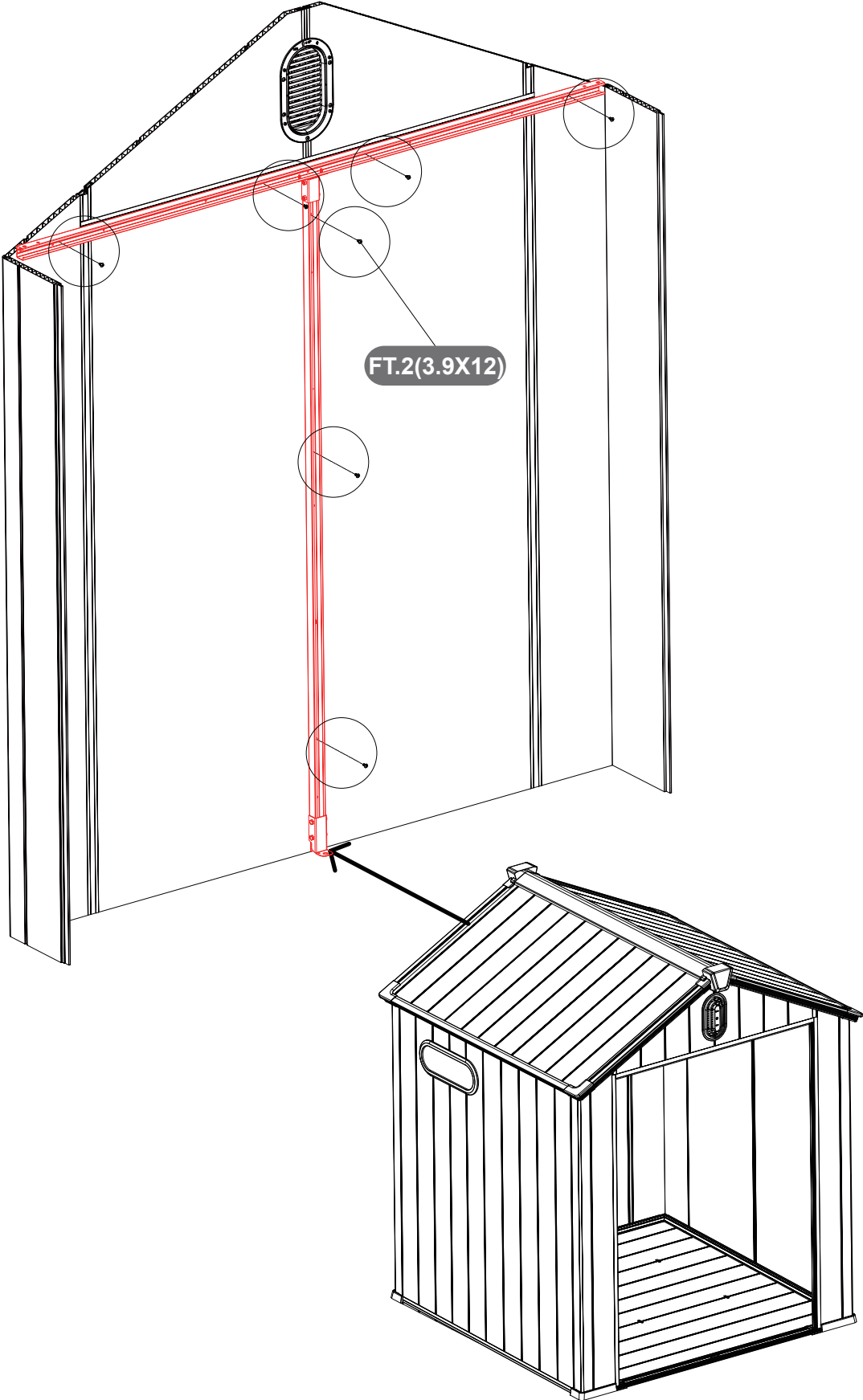

STEP 52

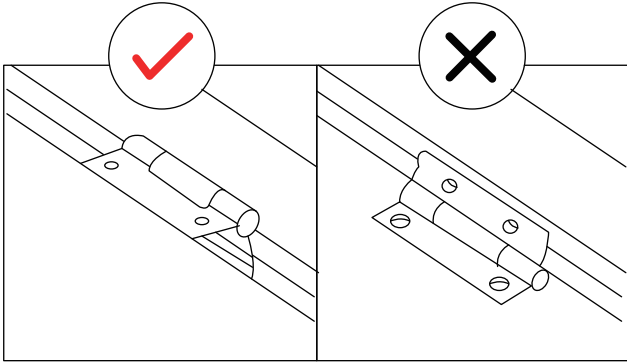

NOTE: The smooth side should be on the inside of the door. Please pay attention to how D.2(kc) and HD.7(kc) are attached to the door.

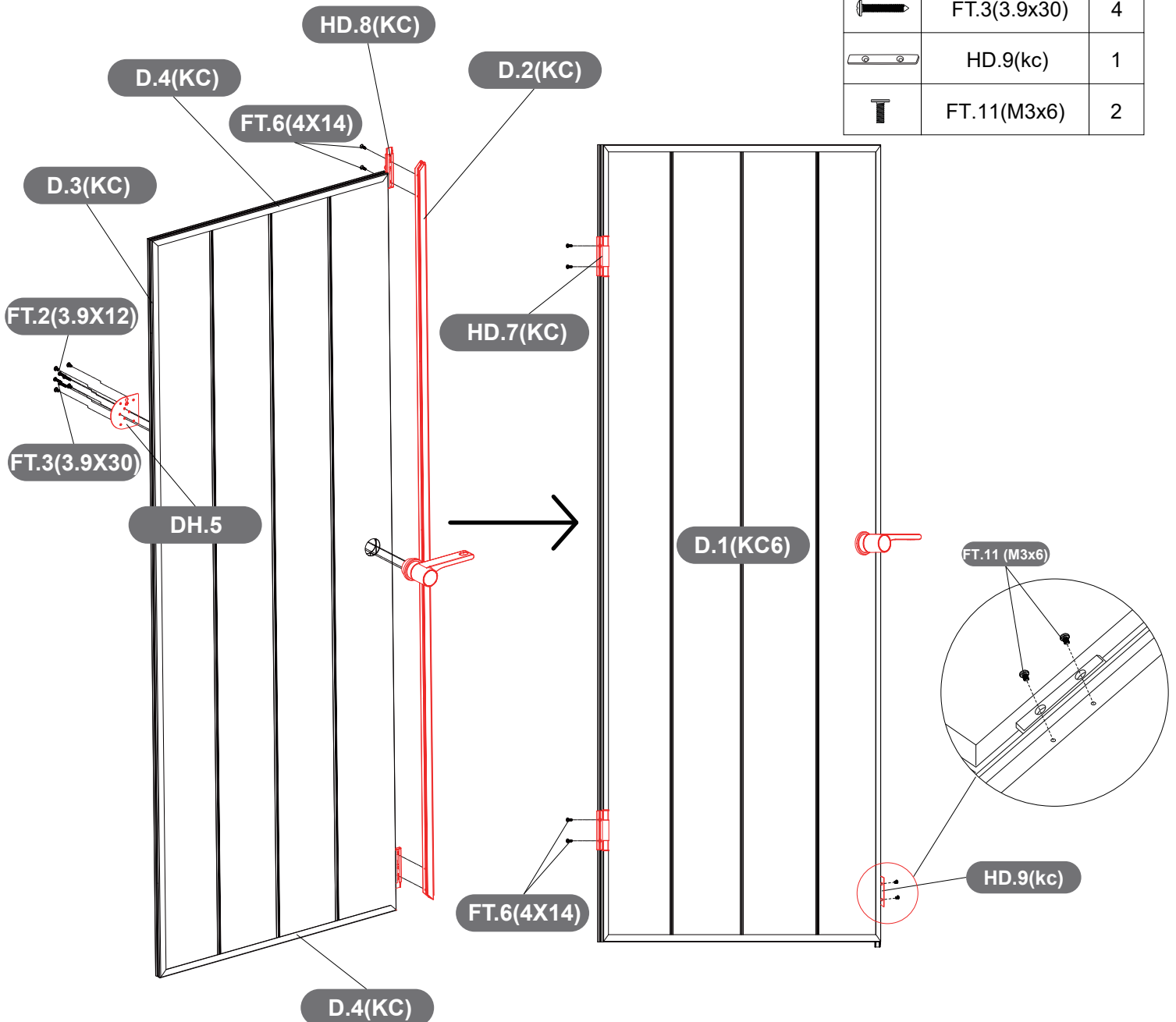

PART	NO	QTY
	HD.8(kc)	2
	D.4(kc)	2
	D.3(kc)	1
	D.2(kc)	1
	DH.5	1
	D.1(kc6)	1
	HD.7(kc)	2
	FT.6(4x14)	20
	FT.2(3.9x12)	4
	FT.3(3.9x30)	4
	HD.9(kc)	1
	FT.11(M3x6)	2







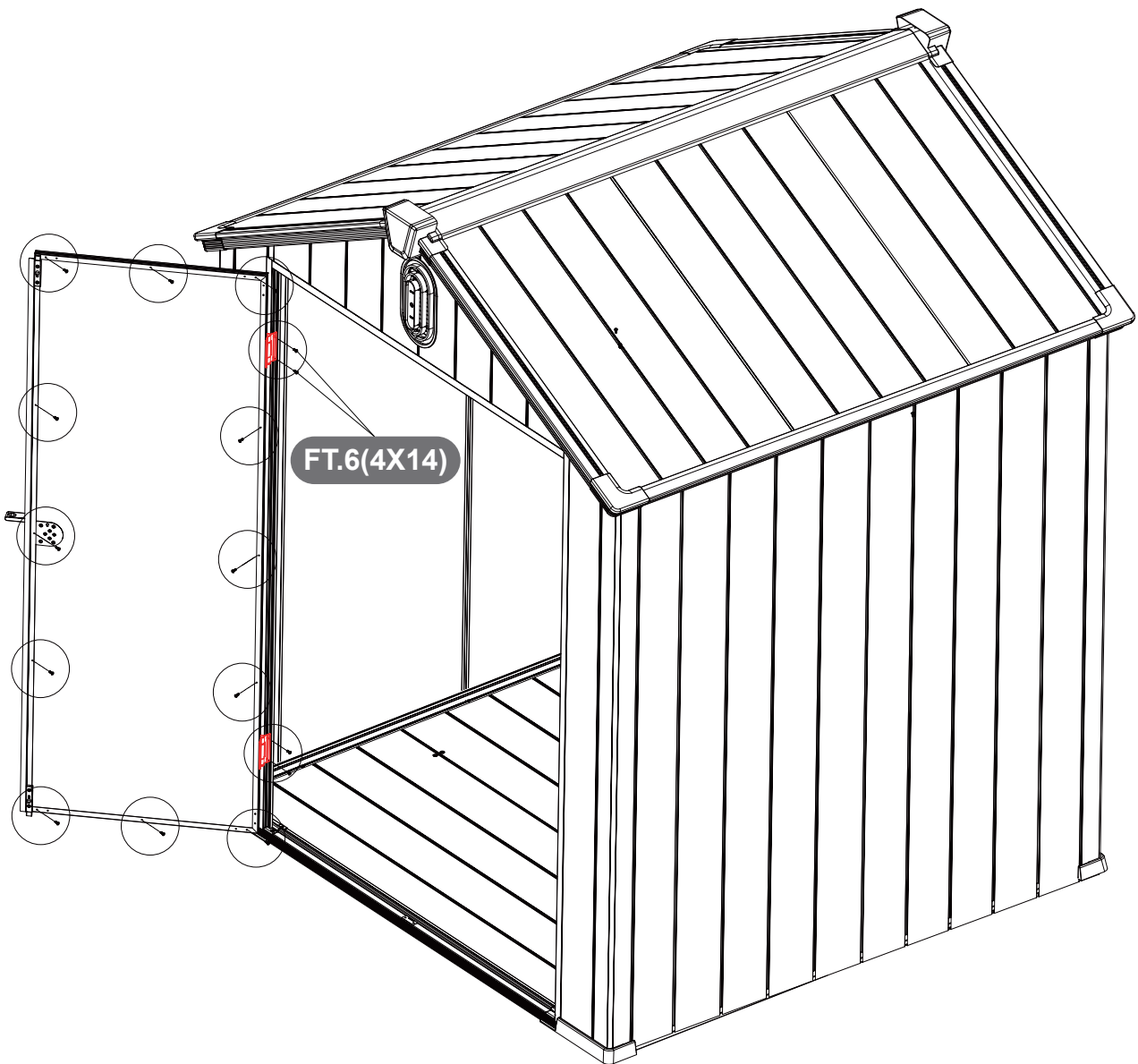



STEP 53

PART	NO	QTY
	HD.7(kc)	2
	FT.6(4x14)	16



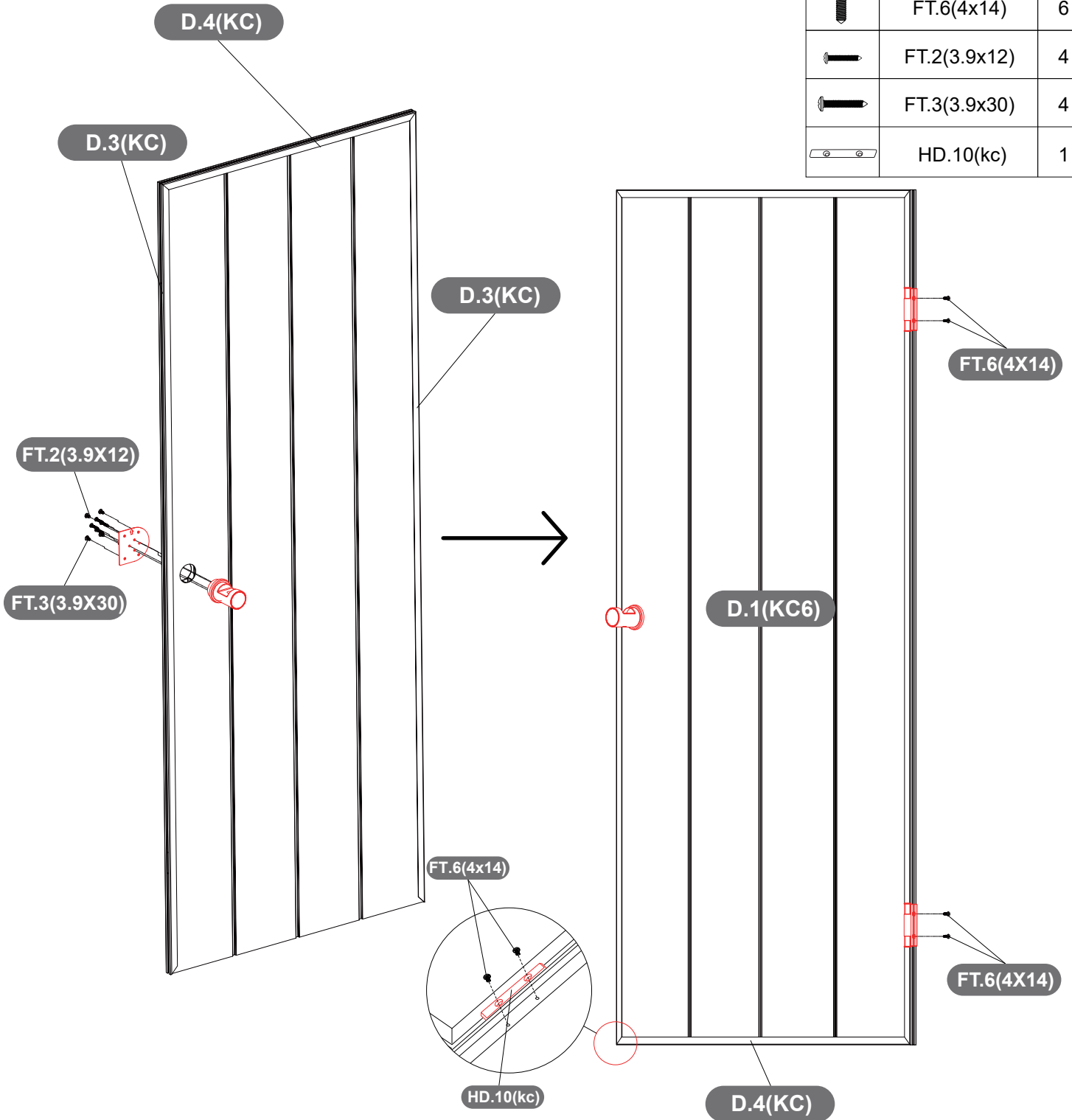

STEP 54

PART	NO	QTY
	D.4(kc)	2
	D.3(kc)	2
	DH.5	1
	D.1(kc6)	1
	HD.7(kc)	2
	FT.6(4x14)	6
	FT.2(3.9x12)	4
	FT.3(3.9x30)	4
	HD.10(kc)	1



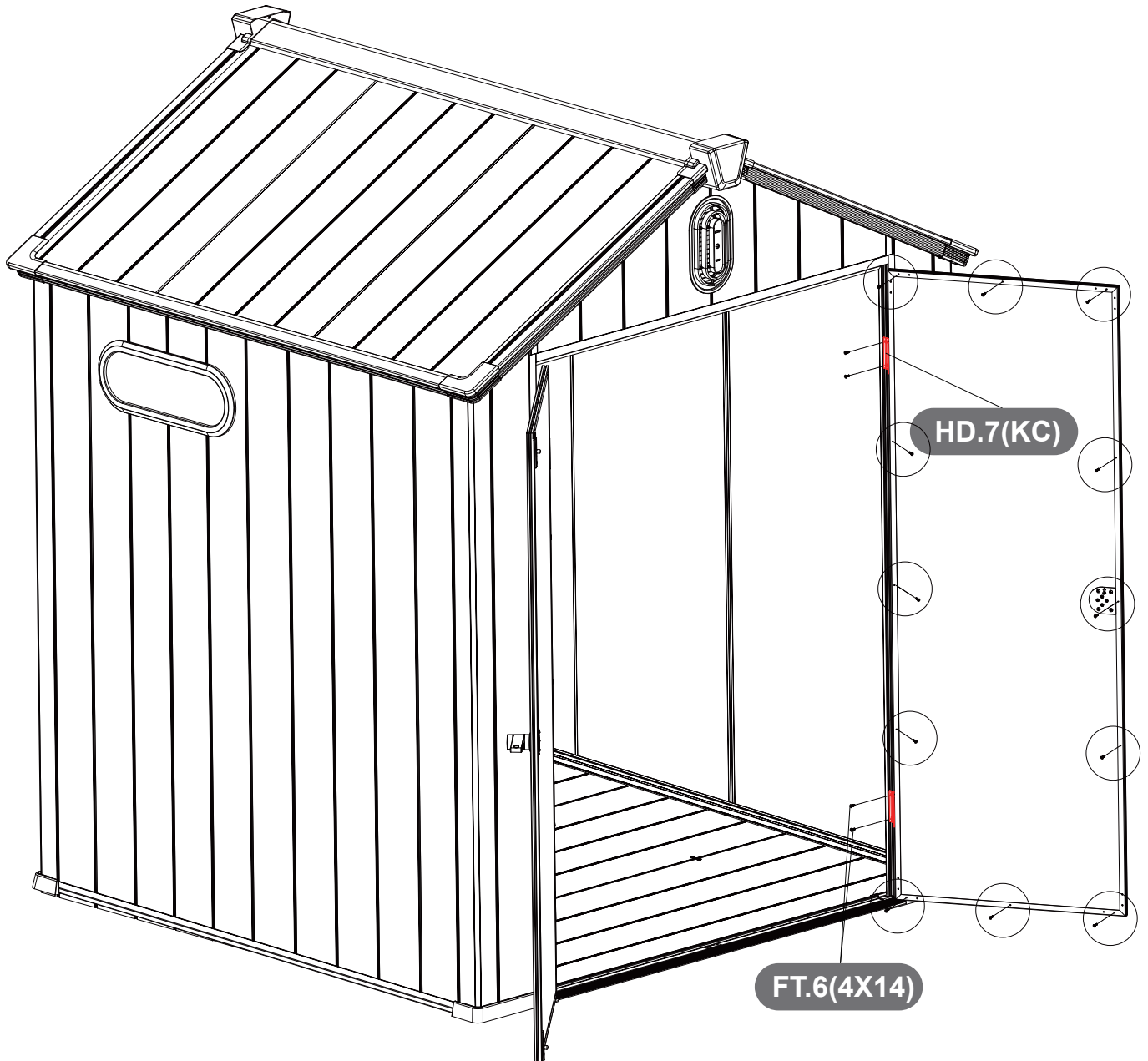

STEP 55

PART	NO	QTY
	HD.7(kc)	2
	FT.6(4x14)	16



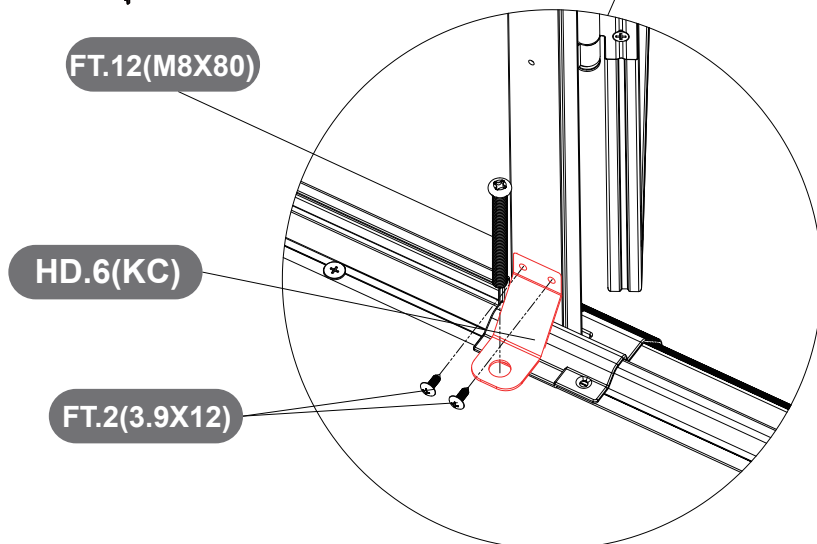

STEP 56

PART	NO	QTY
	HD.6(kc)	4
	FT.2(3.9x12)	8
	FT.12(M8x80)	4



STEP 57

PART	NO	QTY
	FR.14(kc)	1
	FT.12(M8x80)	1

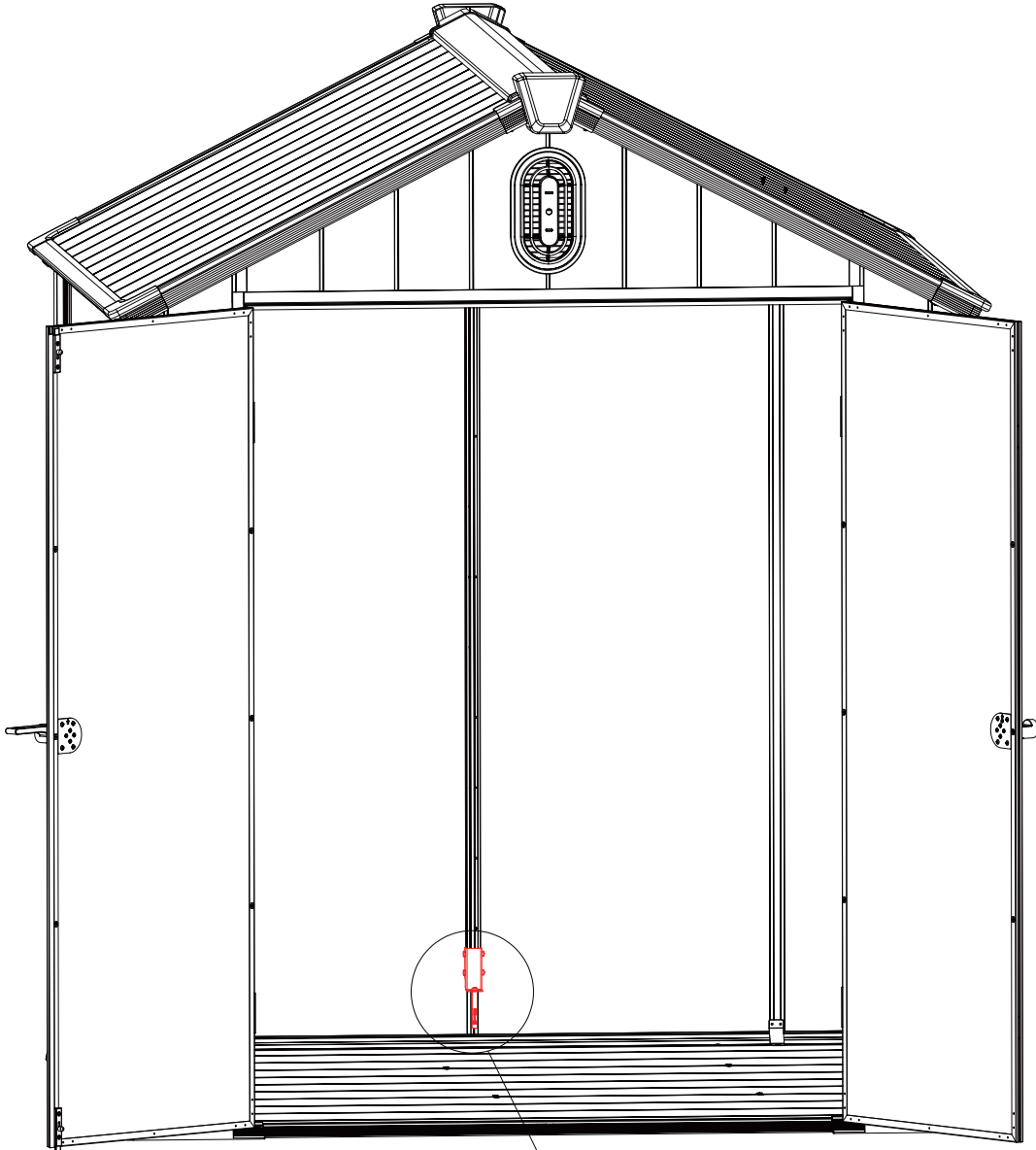

FR.14(KC)

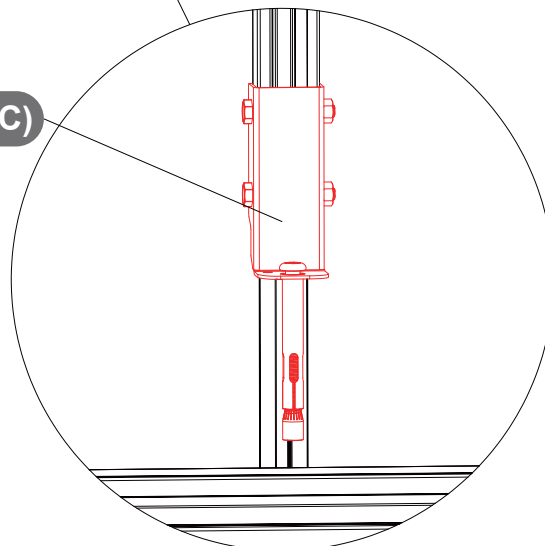

STEP 58

When the door is not closed smoothly, it needs to be leveled or adjust by tighten or loosen the hinge.

PART	NO	QTY
	PADS	2

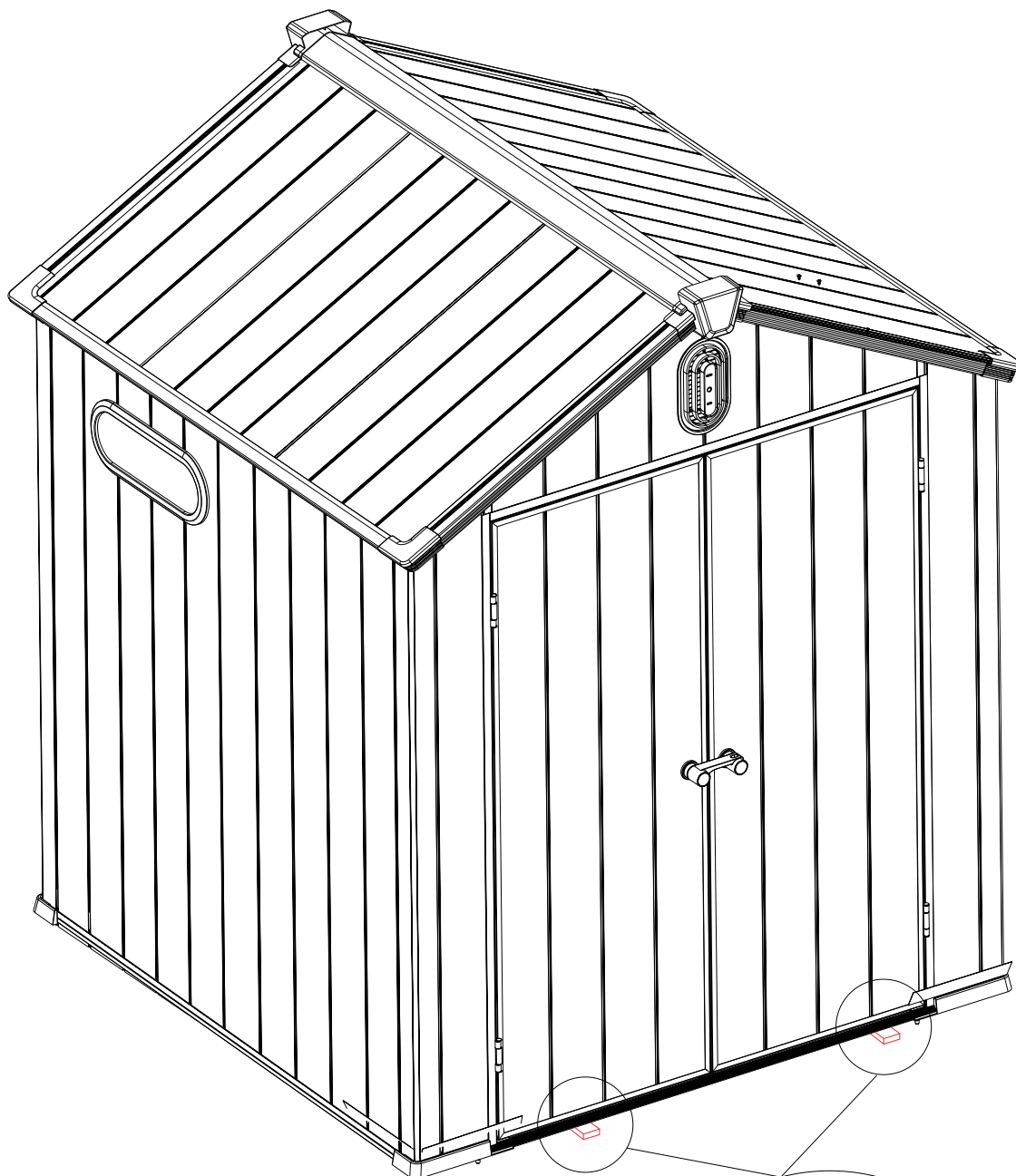

PADS

These pads are optional.

AFTER-SALE SERVICE

If you have any suggestions for our products or find that the products have quality problems, please contact us first, our after-sales team will reply you within 24 hours, and we will do our best to give you solutions until you are satisfied.

Guaranteed Customer Service

Your shopping experience is very important to us!
Feel unsatisfied? **Contact us!**
Have any questions? **Contact us!**

Wanna Share how wonderful our smart promakes your home?
Share your pictures with us.
Any suggestions? **Contact us!**
We gotcha back!



Patiofurniture Serviceteam@outlook.com

