

# Installation & Assembly

## LOVESEAT SOFA

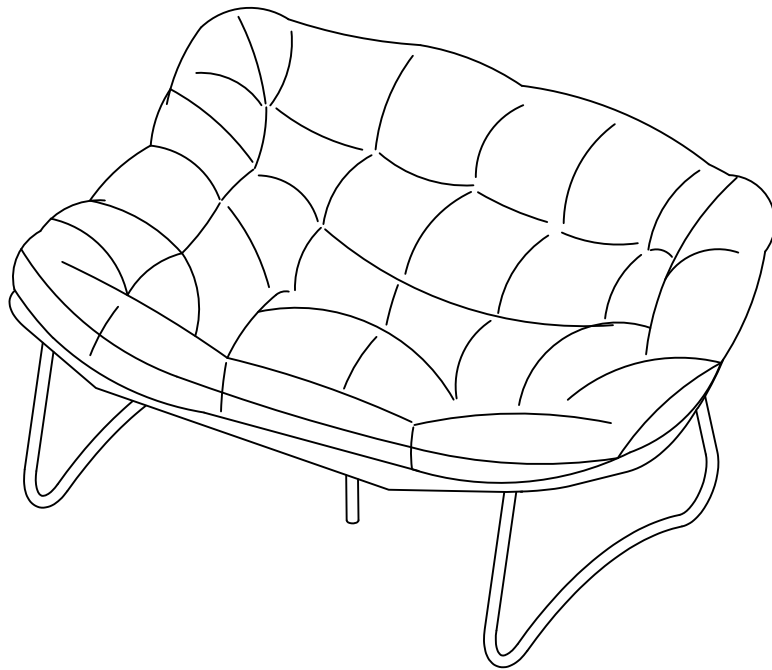







### ATTENTION Section:

1. If you encounter any issues, such as missing accessories or damaged parts, please contact us immediately and include pictures

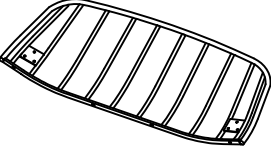
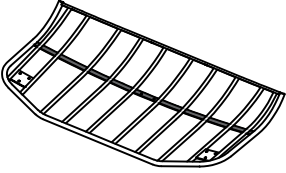
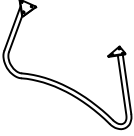
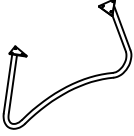
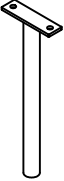
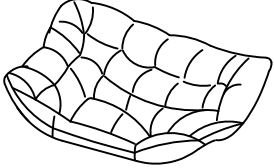
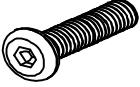
### Assembly Instructions:

1. Assembly requires two people to complete.
2. For optimal assembly, we highly recommend using the provided Allen key. If using a power tool, please set it to a low speed to prevent any damage.
3. Do not fully tighten the screws until all screws are properly aligned with their holes.

# PARTS LIST OF BOX

<p><b>A</b></p>  <p>TOP PLATE 1pc</p>	<p><b>B</b></p>  <p>LOWER PLATE 1pc</p>	<p><b>C</b></p>  <p>LEFT LEG 1pc</p>	<p><b>D</b></p>  <p>RIGHT LEG 1pc</p>
<p><b>E</b></p>  <p>LEG 1pc</p>	<p><b>F</b></p>  <p>SEAT CUSHION 1pc</p>	<p>①</p>  <p>M6*35 4pcs</p>	<p>②</p>  <p>M6*16 14pcs</p>
<p>③</p>  <p>M6 22pcs</p>	<p>④</p>  <p>M6 18pcs</p>	<p>⑤</p>  <p>M6 1pc</p>	<p>⑥</p>  <p>M6 1pc</p>

# STEP 1

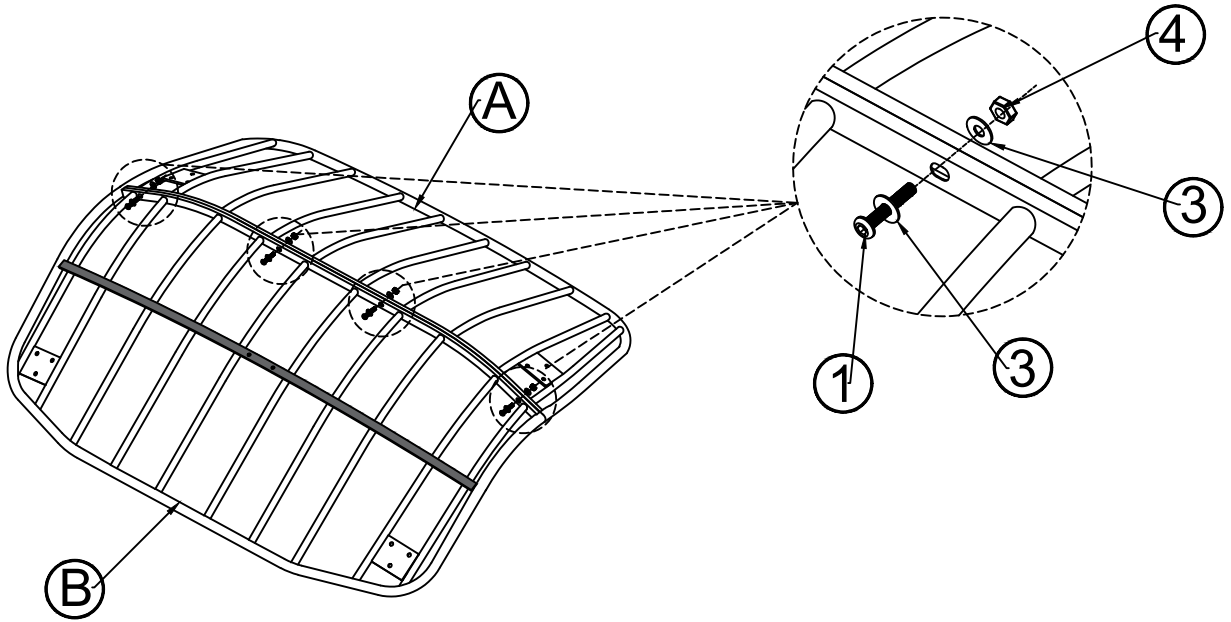

A	1pc	B	1pc	①	4pcs	③	8pcs	④	4pcs	⑤	1pc	⑥	1pc
				M6*35		M6		M6					

# STEP 2

TIPS: Ensure you attach the FRONT side of the leg on PART C and PART D to PART B .

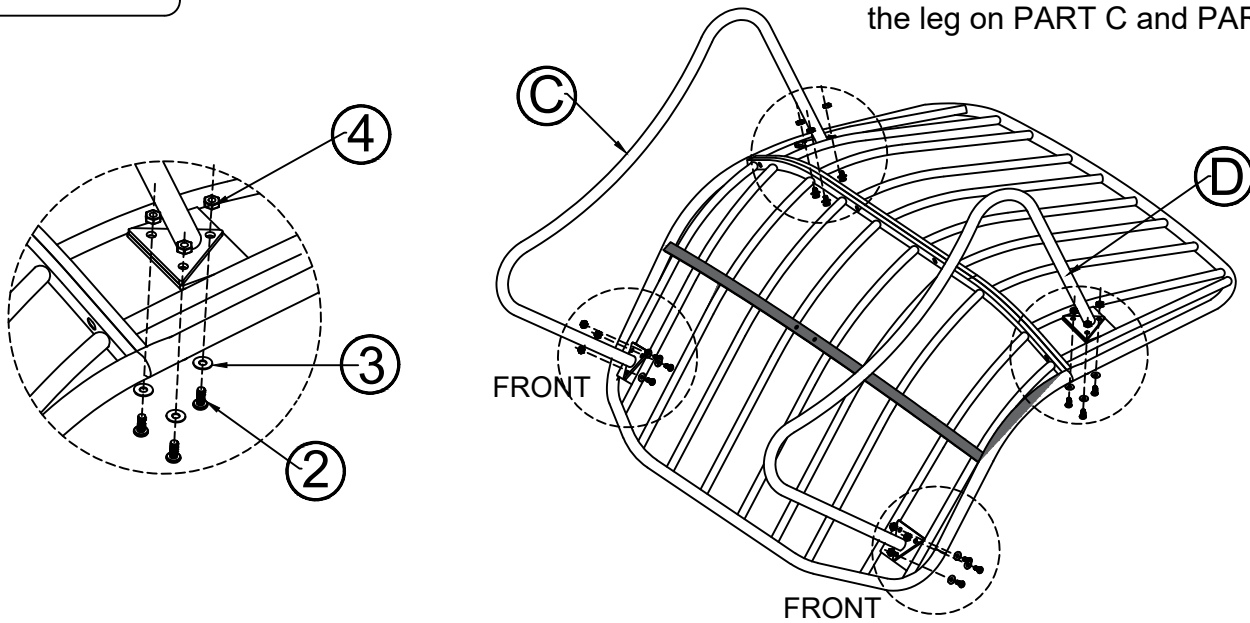





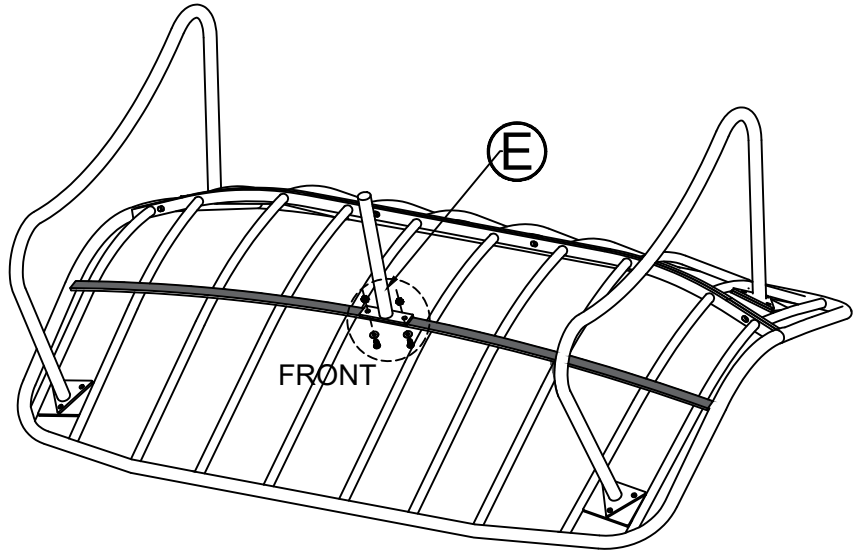
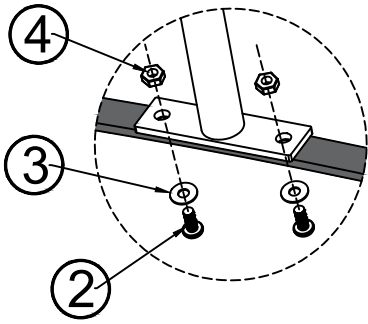

C	1pc	D	1pc	②	12pcs	③	12pcs	④	12pcs	⑤	1pc	⑥	1pc
				M6*16		M6		M6					

Do not fully tighten all screws until assembly is completed.

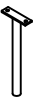
### STEP 3

TIPS: When connecting PART E to PART B, confirm that the FRONT marking on PART E faces the same direction as the FRONT markings on PART C and PART D.



E	1pc	②	2pcs	③	2pcs	④	2pcs	⑤	1pc	⑥	1pc
											
		M6*16	M6	M6							

### STEP 4

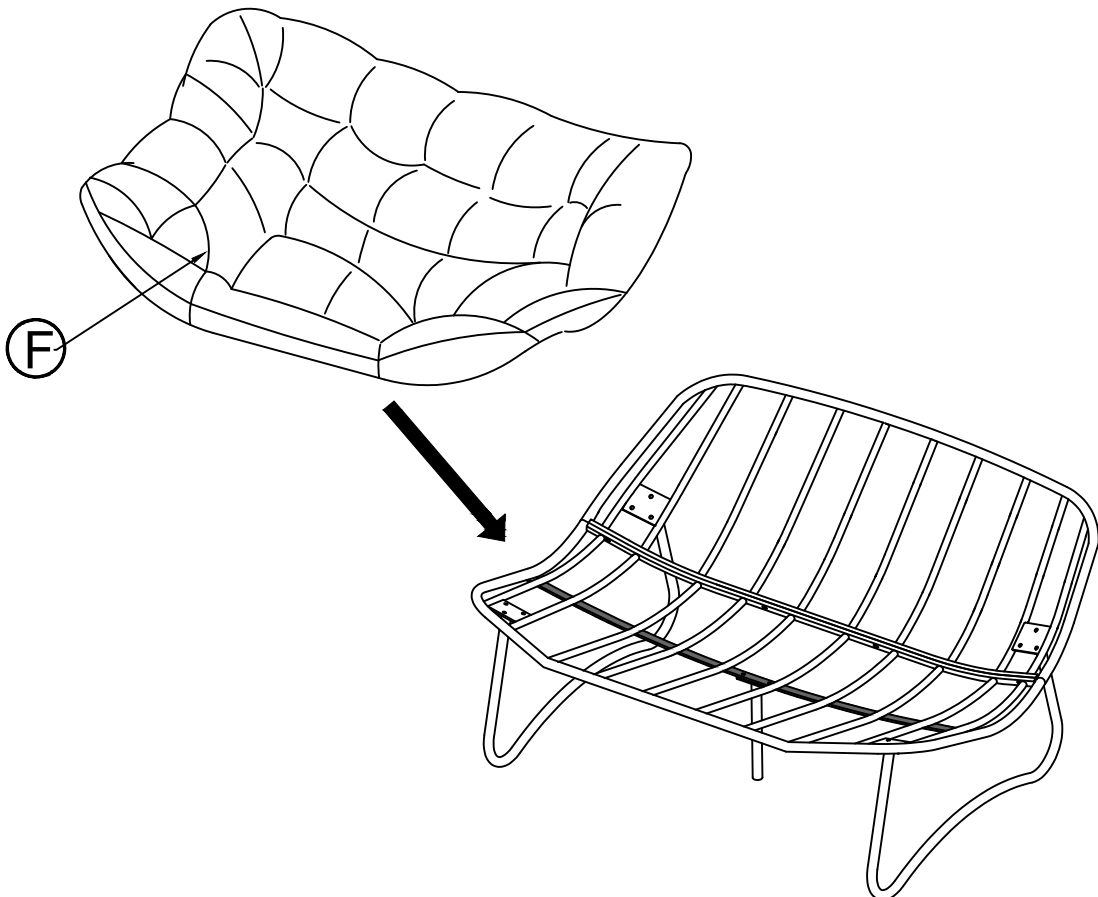

F	1pc
	

Do not fully tighten all screws until assembly is completed.