

Assembly Instruction

Go to the **Care+Maintenance** selection.

Tools Required: Flathead screwdriver, Phillips screwdriver, pliers, wire cutters, wire strippers, electrical tape, safety glasses.

Light Source: Integrated 27W LED

Compatible Dimmer Switches: Lutron DVELV-300P or Lutron SELV-300P.

Estimated Assembly Time: 20-30 minutes

Preparation: Identify and inspect all parts before beginning installation. Check package content list and diagrams below to be sure all parts are present. If any parts are missing or damaged, do not attempt to assemble, install, or operate the fixture. Contact customer service for replacement parts.

⚠ Warnings and Cautions

Turn off electricity at circuit breaker or main fuse box before installation. Consult a licensed electrician if in doubt.

These instructions are provided for your safety. It is very important you read them completely before installing the fixture. We strongly recommend that a licensed, professional electrician perform the installation.

Package Contents

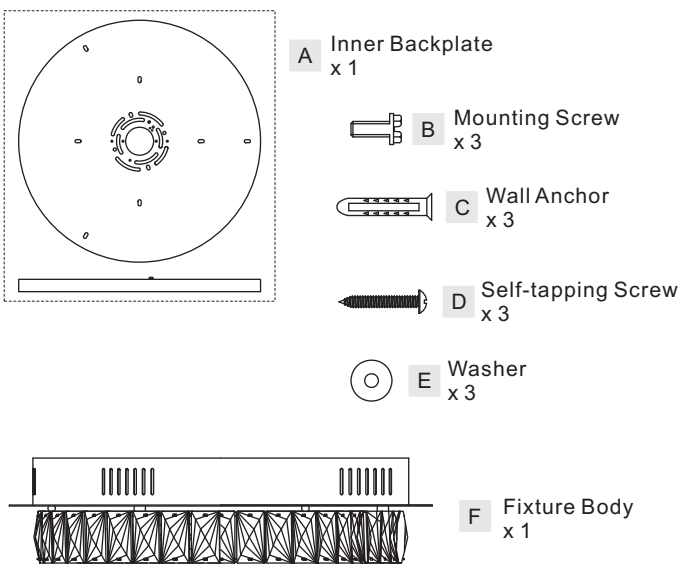

STEP 2 - Attach Lanyard

- The purpose of the lanyard is to provide the installer a means to support the fixture from the junction box while connecting the electrical wires. This enables the fixture to hang from the junction box and your hands are free to make the wire connections.
- Turn the Button Stop so it may be inserted into the Inner Backplate Slot. Make sure the Button Stop is completely inside the Inner Backplate (A). Slowly release the fixture to make sure it is supported by the Button Stop. Proceed to the wiring steps in the next step. Once you are complete with the wiring there is nothing to do with Lanyard. The Lanyard will push into the junction box when the fixture is placed for final mounting.

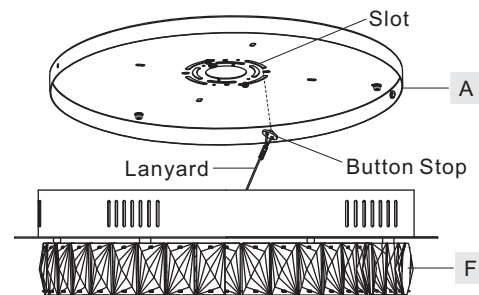

Figure 2

STEP 1 - Attach Inner Backplate to Outlet Box

- Attach the Inner Backplate (A) onto the Outlet Box and make four marks on the ceiling from keyholes on the Inner Backplate (A).
- Remove the Inner Backplate (A) and drill proper holes on the ceiling from marks. Insert Wall Anchors (C) into the holes properly. Attach the Inner Backplate (A) to Outlet Box. Thread Outlet Box Screws (not Supplied) into mounting holes on the Outlet Box. Pass Washers (E) over Self-tapping Screws (D) and thread Self-tapping Screws (D) into Wall Anchors (C). Hand tighten until snug.

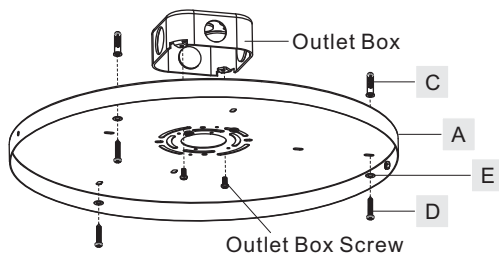

Figure 1

STEP 3 - Wire Connections

- Use standard wire connectors (not included) to make all wire connections. Twist connectors until wires are tightly joined together. Wrap each connection with approved electrical tape and carefully stuff all the connected wires into the Outlet Box.

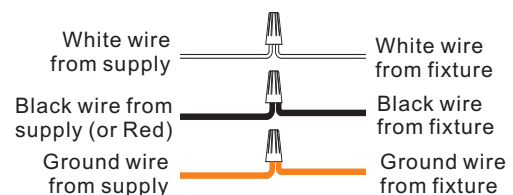

Figure 3

STEP 4 – Attach Fixture Body to Inner Backplate

A. Fit supply wires and ground wire in the ceiling canopy of Fixture Body (F) properly. Line up the holes on the side of the ceiling canopy to the mounting holes on the side of the Inner Backplate (A). Secure them with Mounting Screws (B). Tighten until snug with screwdrivers.

Your fixture is now assembled and ready to use. Enjoy!

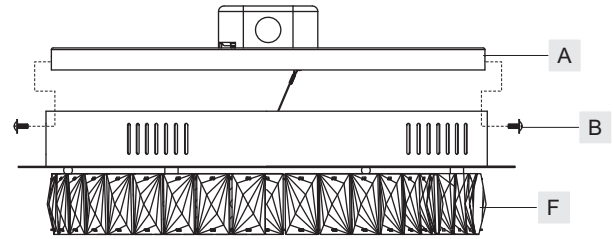
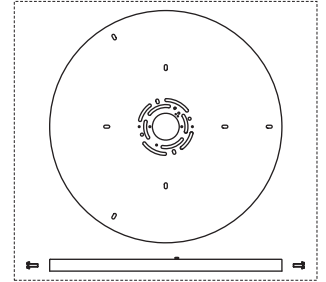
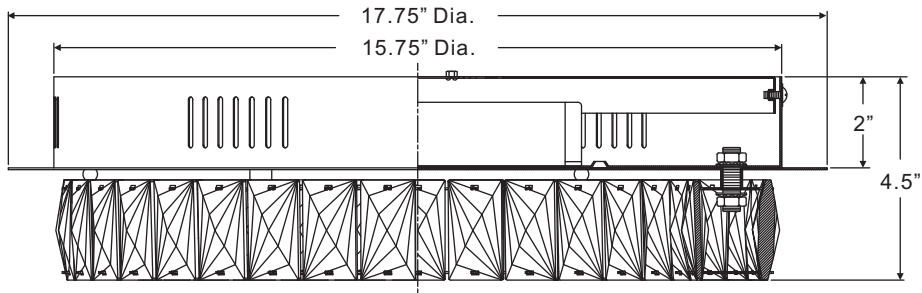

Figure 4

FINISH: POLISHED CHROME



NOTE: ALL DIMENSIONS ARE ROUNDED UP TO THE NEAREST 1/4"