

# ASSEMBLY INSTRUCTION

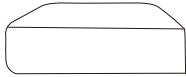

A\*3

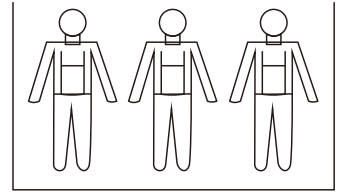

B\*1

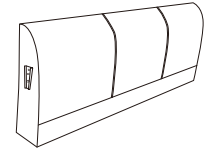

C\*1

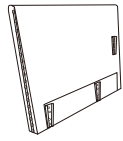

D\*1 LEFT

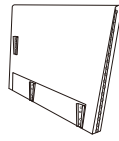

D\*1 RIGHT

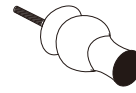

E\*4



G\*4

## STEP1

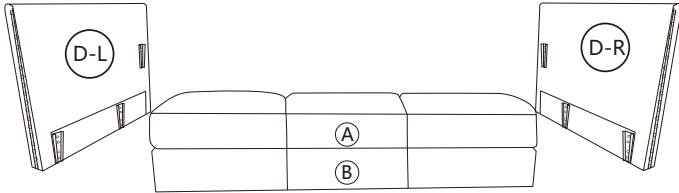

## STEP2

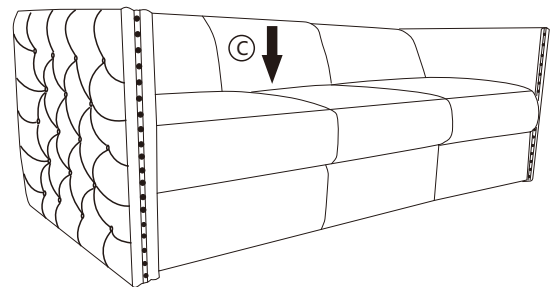

## STEP3

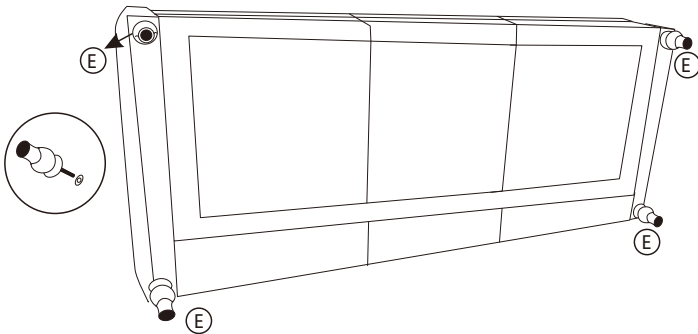

## STEP4

