

# Deck Mounted Bird Bath with Fountain

## SECTION A

## Parts List

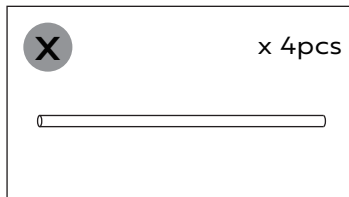
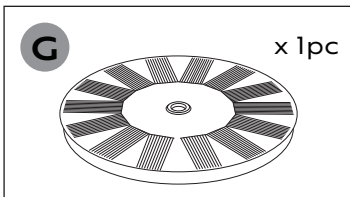
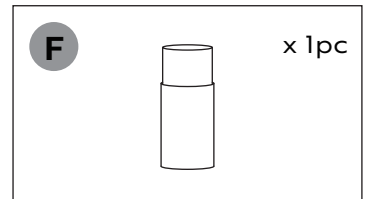
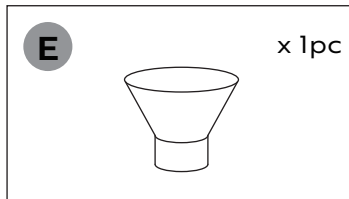
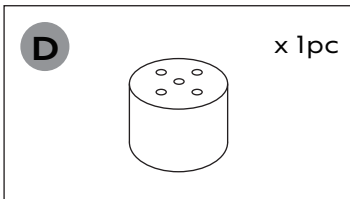
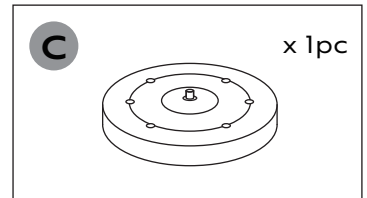
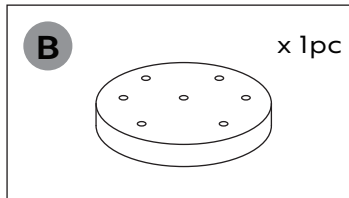
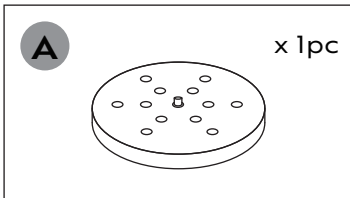
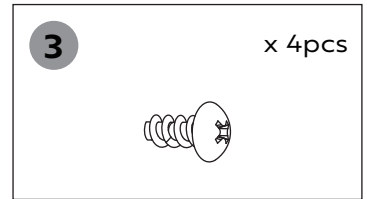
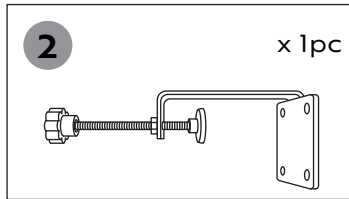
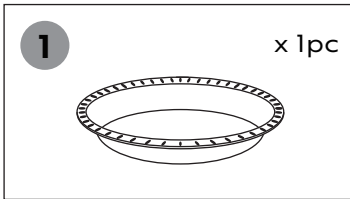

**STEP 1**

Attach the bracket (Part 2) to the bottom of the basin (Part 1) using four screws (Part 3).

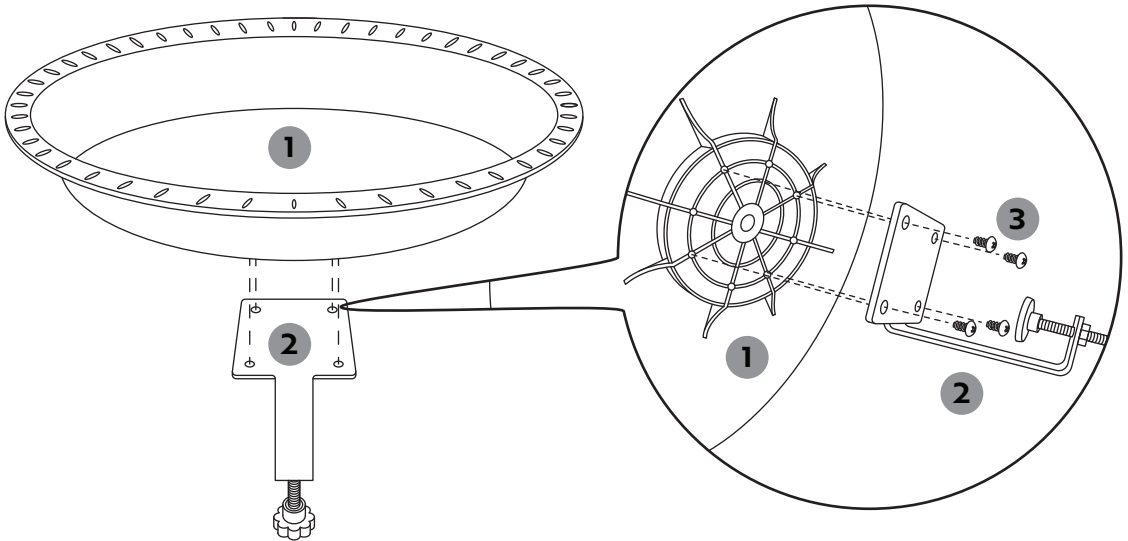
**STEP 2**

Tighten the bracket by adjusting the clamp at the bottom.

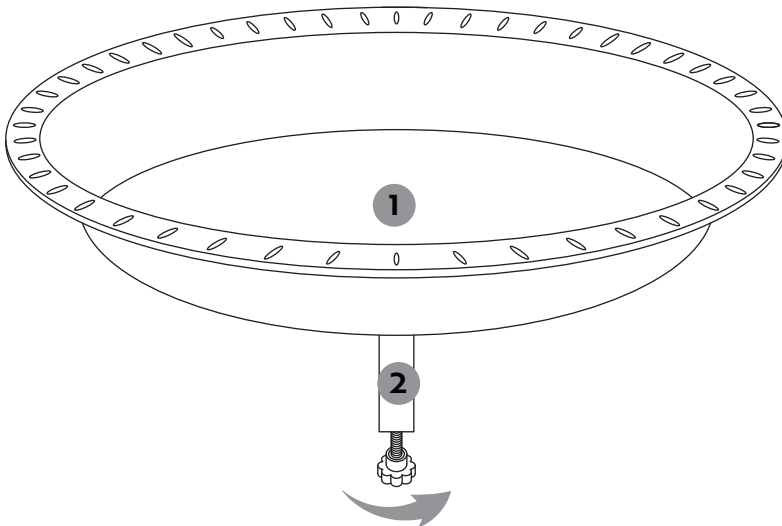



# Installation

## STEP 3

Choose a spout for your fountain!

G+F+D

G+F+E+A/B/C

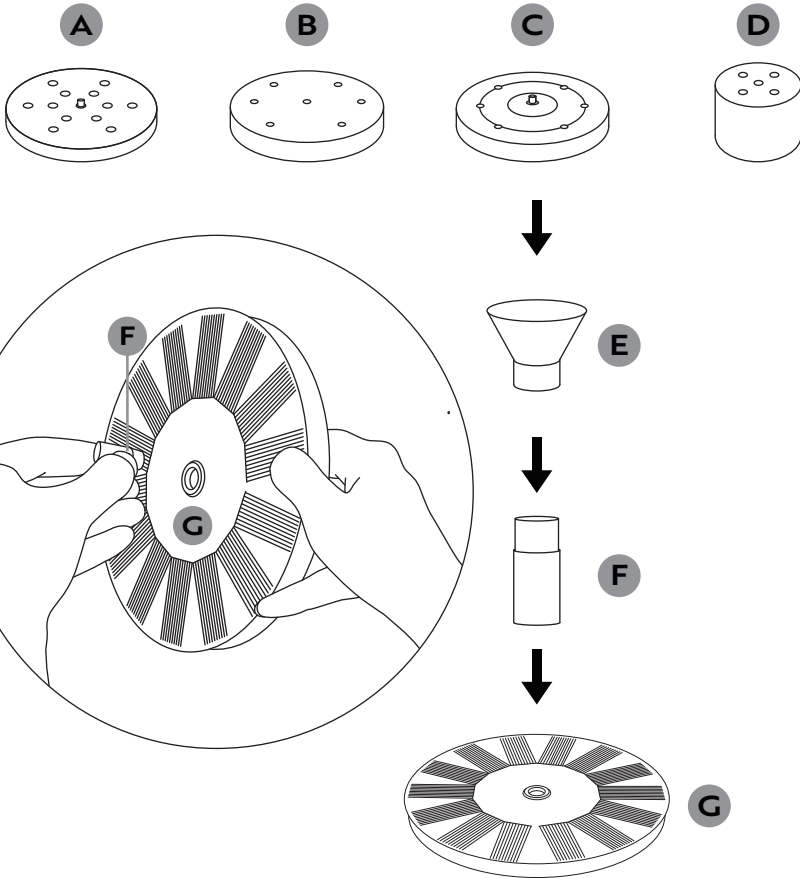

**STEP 4**

Fix the anti-collision poles (Parts X) at the four ends of the solar fountain pump (Part G), and place it in the basin.

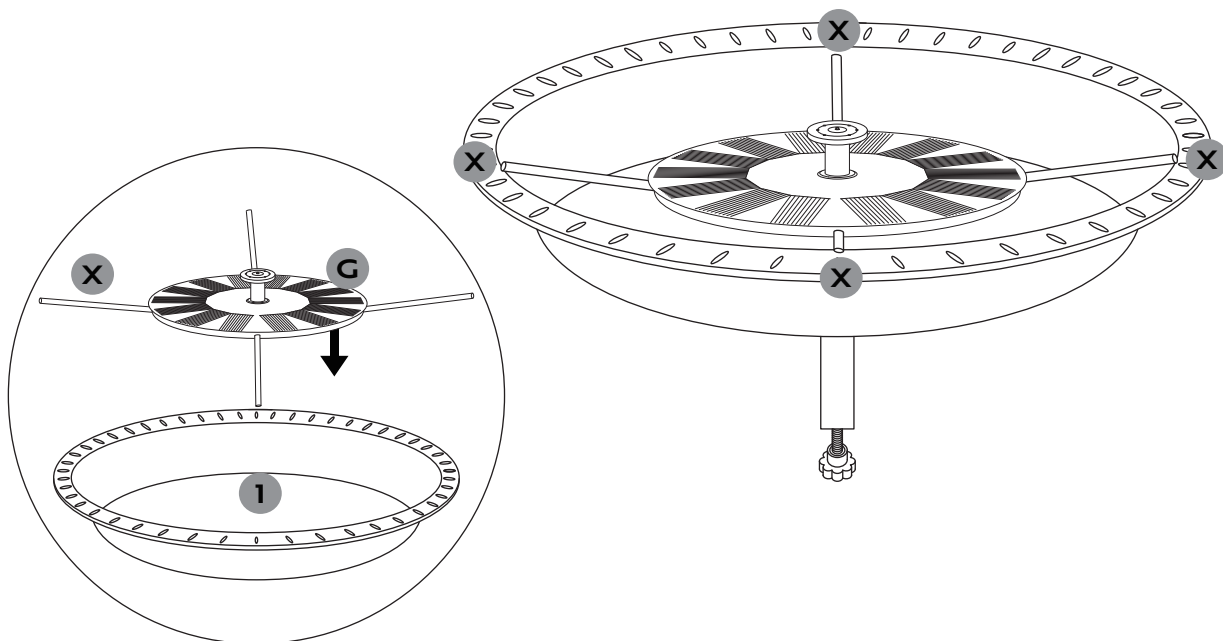

## Warning



1. The metal support bracket is heavy; do not throw it carelessly to avoid injury.
2. Do not store corrosive liquids in the bowl to avoid damage or safety risks.
3. Ensure the product is securely installed with tightened screws to prevent falling or injuries. Avoid placing it on high railings.