

"BOOKCASE"

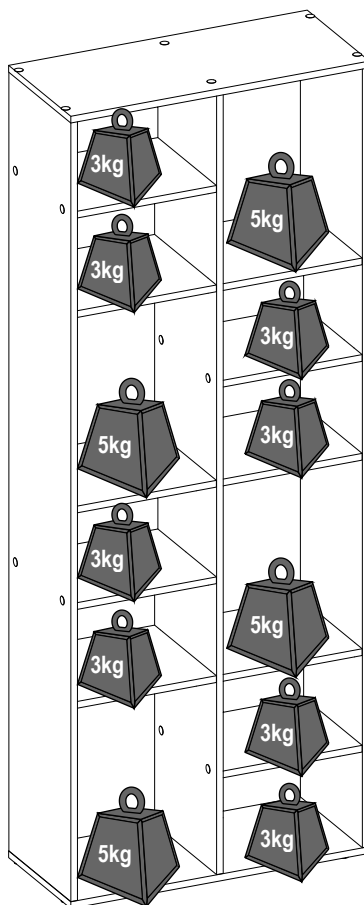
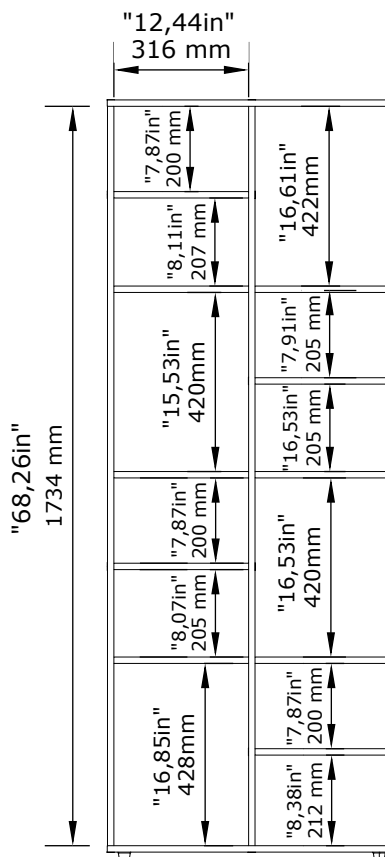
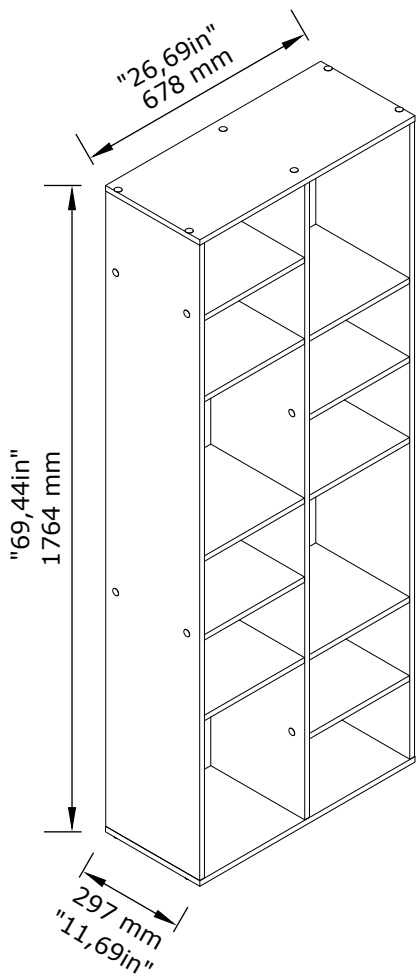

Tools needed to assemble the furniture: - Outils nécessaires pour assembler les meubles:

Werkzeuge, die für die Montage der Möbel benötigt werden: - Herramientas necesarias para armar el mueble:

Ferramentas necessárias para montar o móvel: - Strumenti necessari per assemblare il mobile:

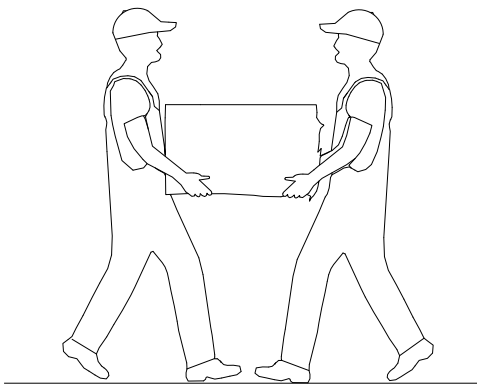
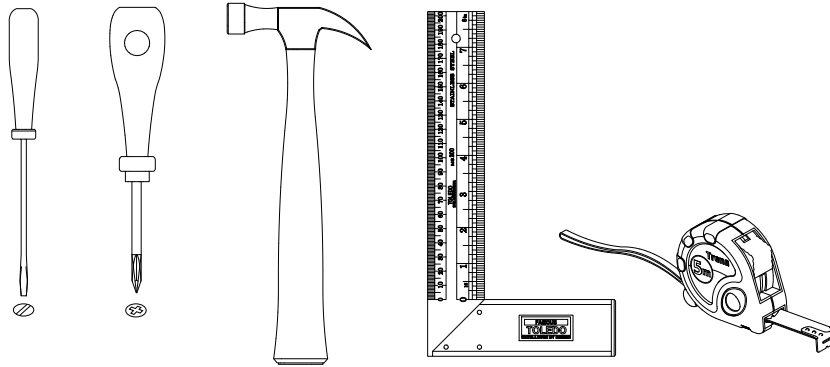

The assembly must be done by two people.

L'assemblage doit être effectué par deux personnes.

Es wird empfohlen, dass zwei Personen den Artikel montieren.

El montaje debe ser efectuado por dos personas.

A montagem deve ser efetuada por duas pessoas.

Il montaggio deve essere effettuato da due pers

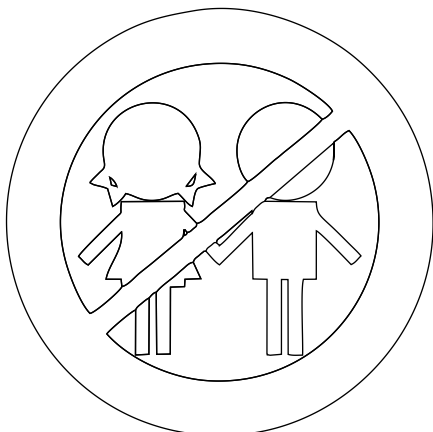

This product contain small parts, please,
keep out of reach of children.

Ce produit contient de petites pièces, s'il vous plait,
à conserver hors de portée des enfants.

Bitte halten Sie kleine Teile außerhalb der Reichweite von Kindern.

Este producto contiene piezas pequeñas,
mantener fuera del alcance de los niños.

Este produto contém peças pequenas, por favor,
mantenha fora do alcance das crianças.

Questo prodotto contiene piccole parti,
si prega di tenerle fuori dalla portata dei bambini.

In case of doubt, compare the hardware
with the full-size images below.

En cas de doute, veuillez comparer le matériel avec les images en taille réelle
ci-dessous.

Vergleichen Sie im Zweifelsfall die Schrauben mit den Abbildungen in
Originalgröße.

En caso de dudas, compare las herrajes con las imágenes a seguir en tamaño
real.

Em caso de dúvida, compare as ferragens com as imagens abaixo em
tamanho real.

In caso di dubbio, confronta le ferramenta con le immagini sottostanti a
grandezza reale.

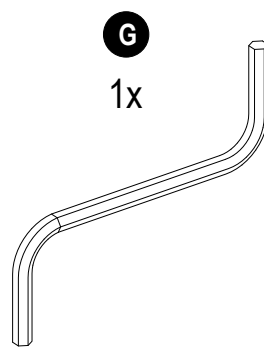
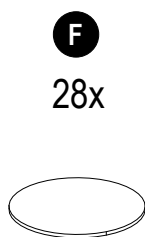
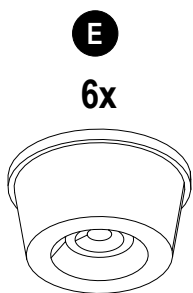
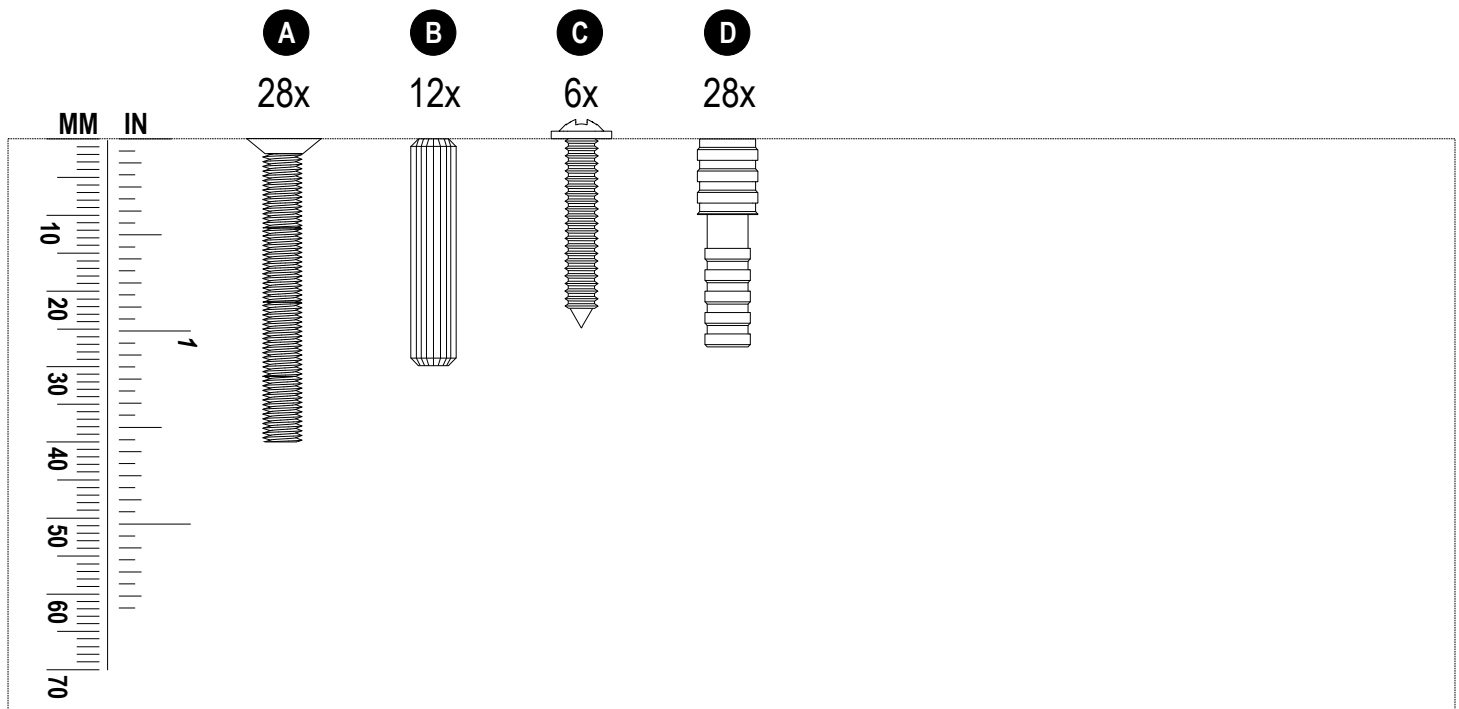

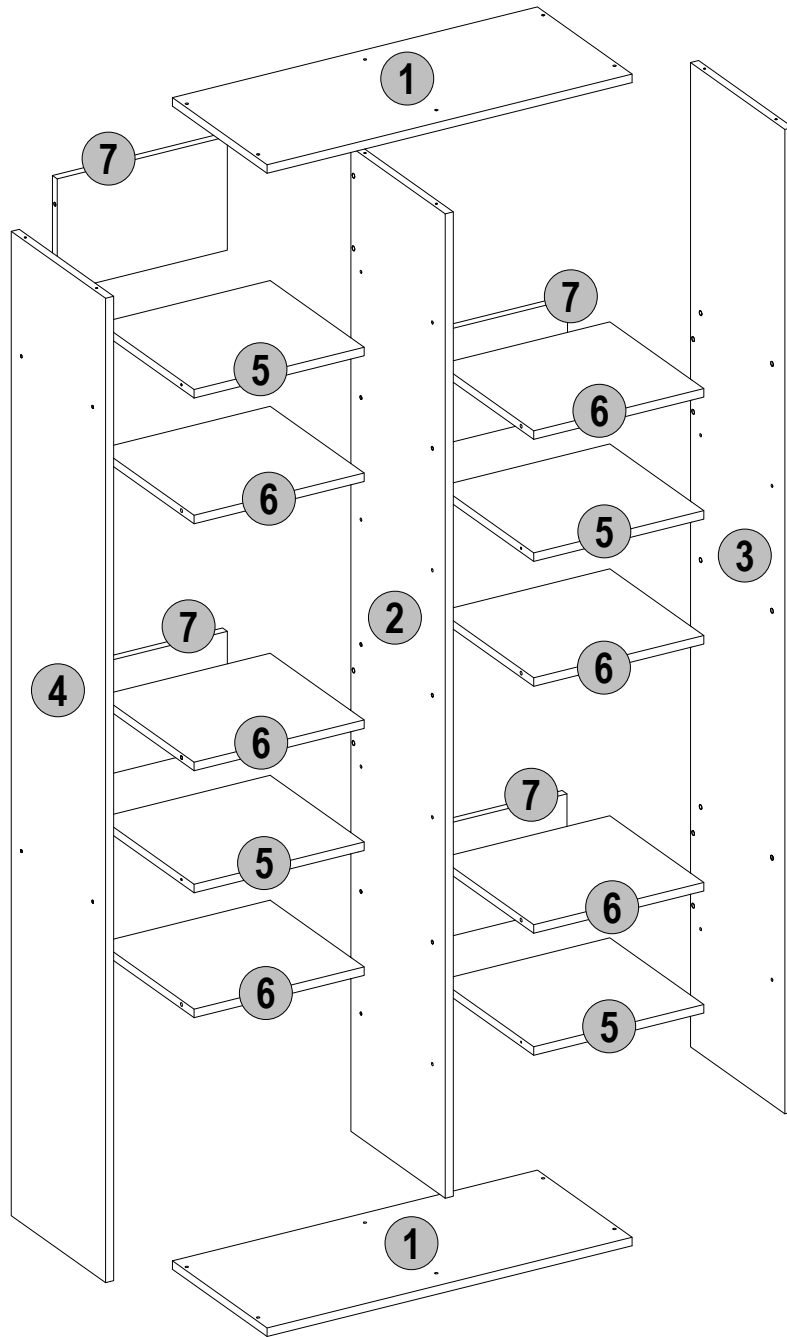

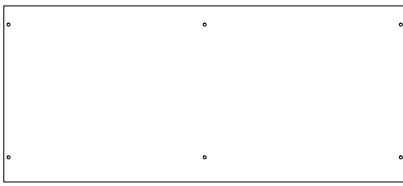

1 (679 x 298 mm)
(26,73 x 11,73 in)

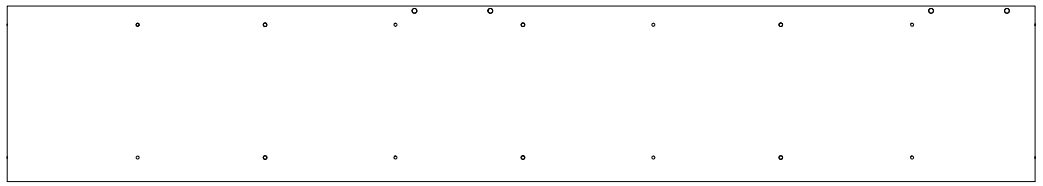

2 (1734 x 297 mm)
(68,27 x 11,69 in)

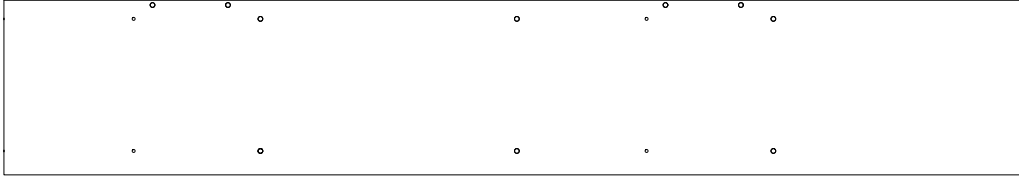

3 (1734 x 297 mm)
(68,27 x 11,69 in)

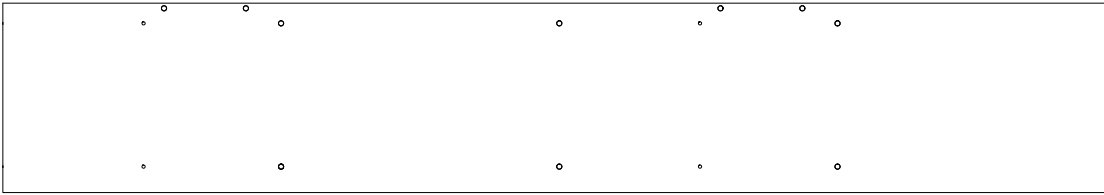

4 (1734 x 297 mm)
(68,27 x 11,69 in)

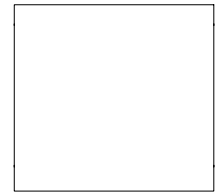

5 (316 x 296 mm)
(12,44 x 11,65 in)

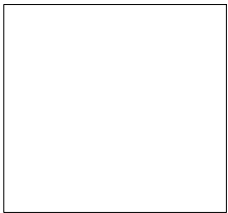

6 (316 x 296 mm)
(12,44 x 11,65 in)

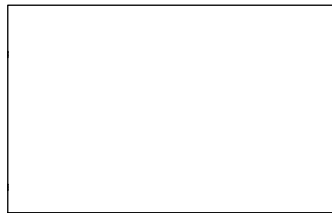

7 (316 x 200 mm)
(12,44 x 7,87 in)

ATTENTION - AVERTISSEMENT - ACHTUNG - ATENCIÓN - ATENÇÃO - ATEMZIONE

Assemble the furniture on a clean and flat surface and cover it with the cardboard of the packaging.

Assemblez le meuble sur une surface propre et plane et couvrez-le avec le carton de l'emballage du produit.

Um Beschädigungen zu vermeiden, montieren Sie den Artikel auf einer weichen, sauberen Unterlage.

Tipp: Legen Sie den Artikel auf dem Verpackungskarton.

Montar el mueble sobre una superficie limpia y plana y cubrirlo con el cartón del embalaje del producto.

Montar o móvel sobre uma superfície limpa e plana e forrá-la com o papelão da embalagem do produto.

Montare il mobile su una superficie pulita e piana e rivestirla con il cartone d'imballaggio del prodotto.

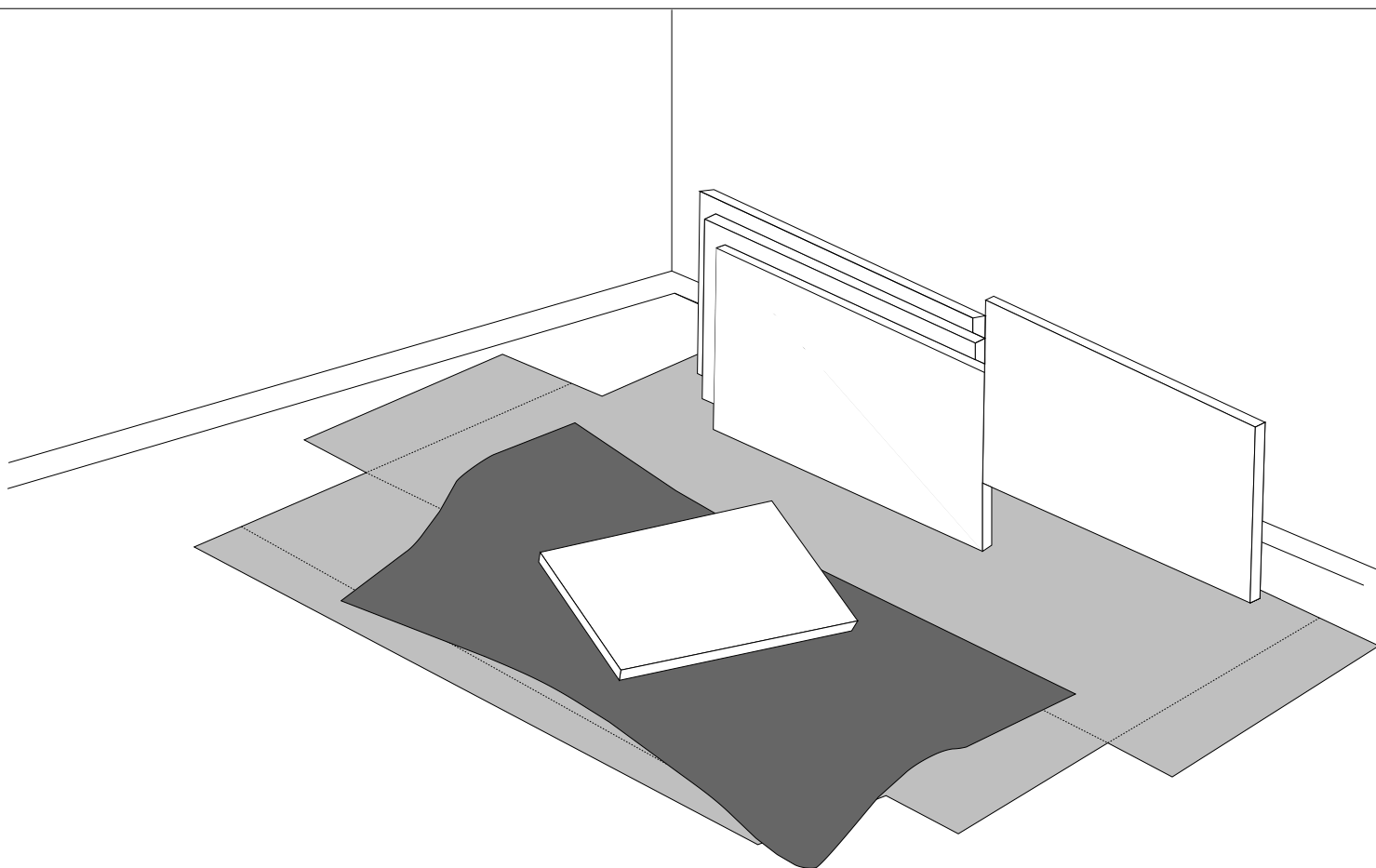
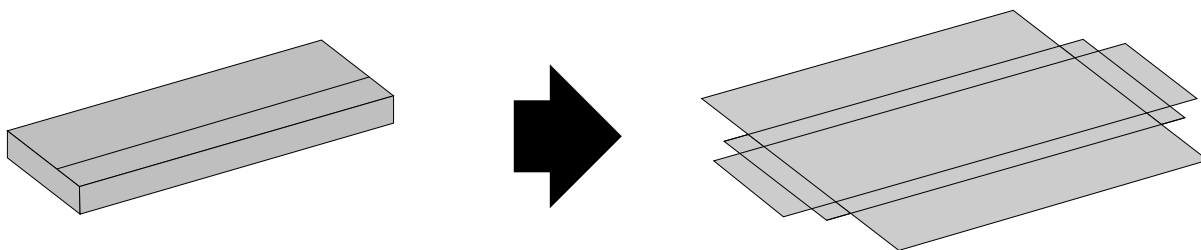

1

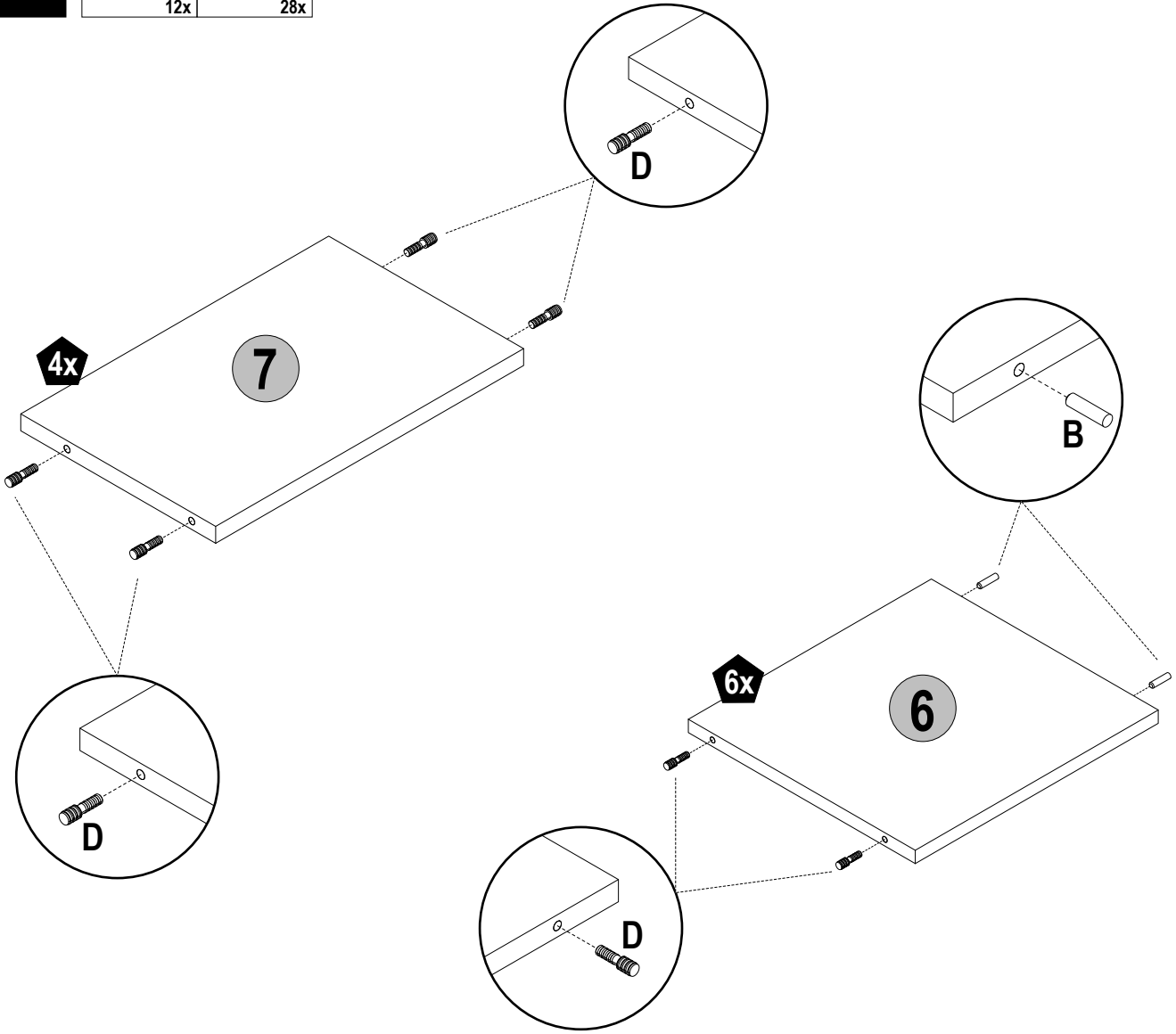
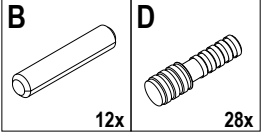

2

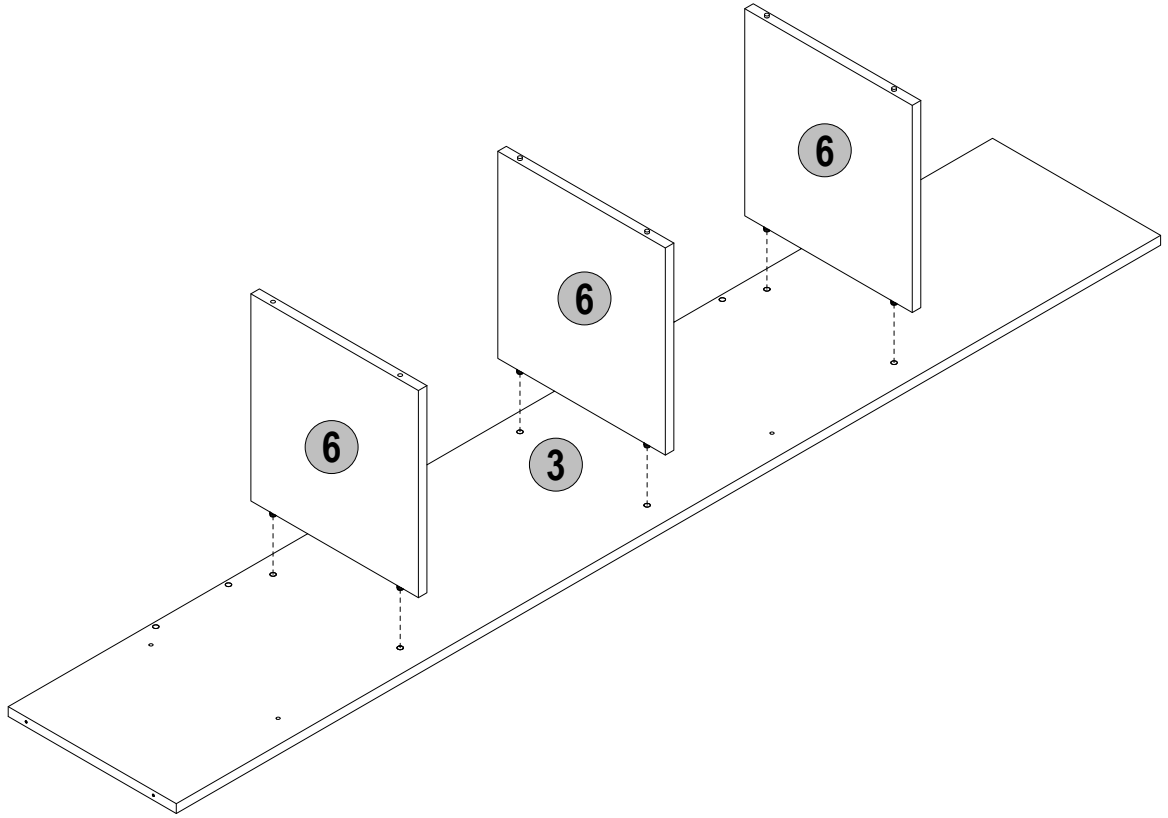

3

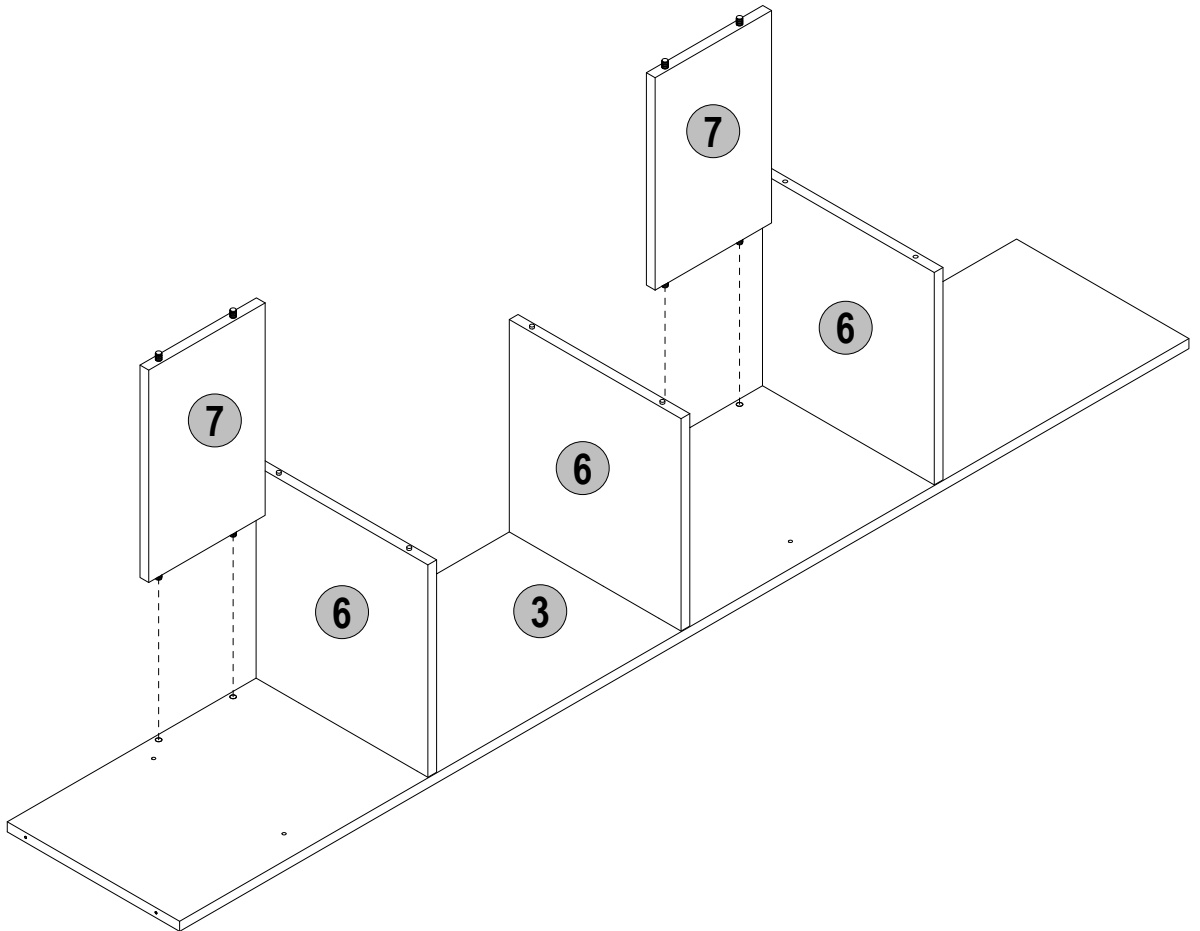

4

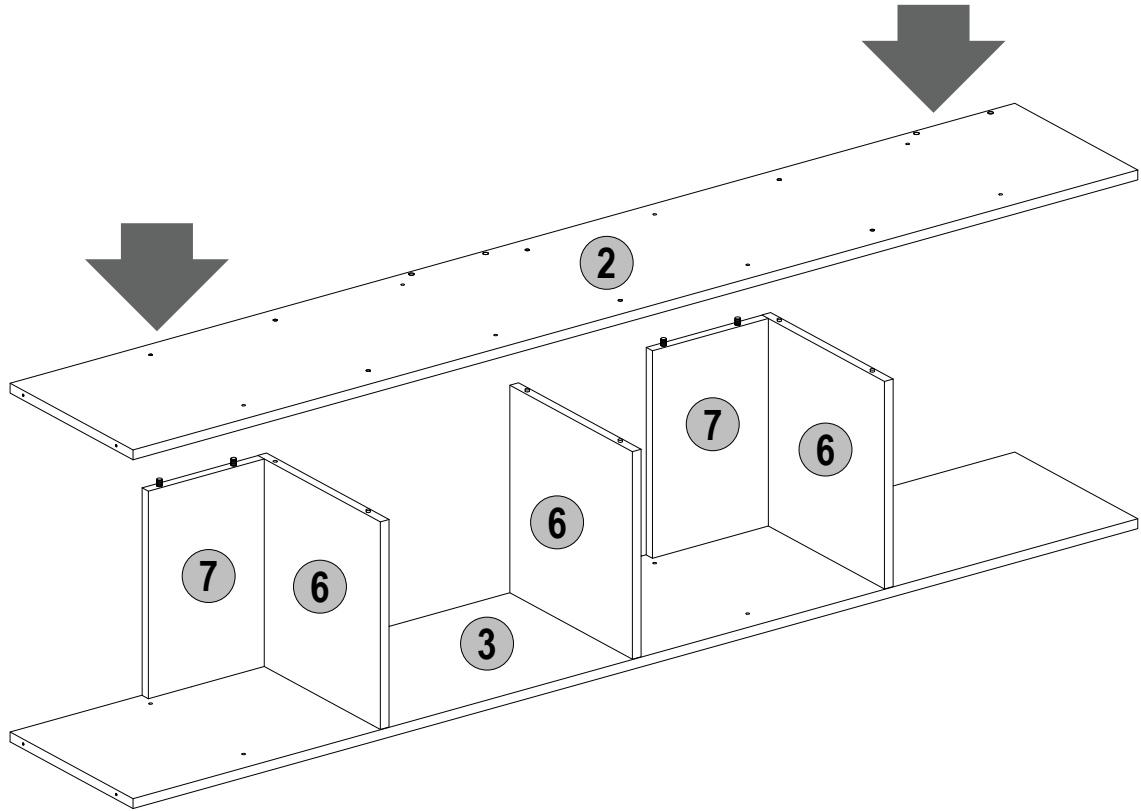

5

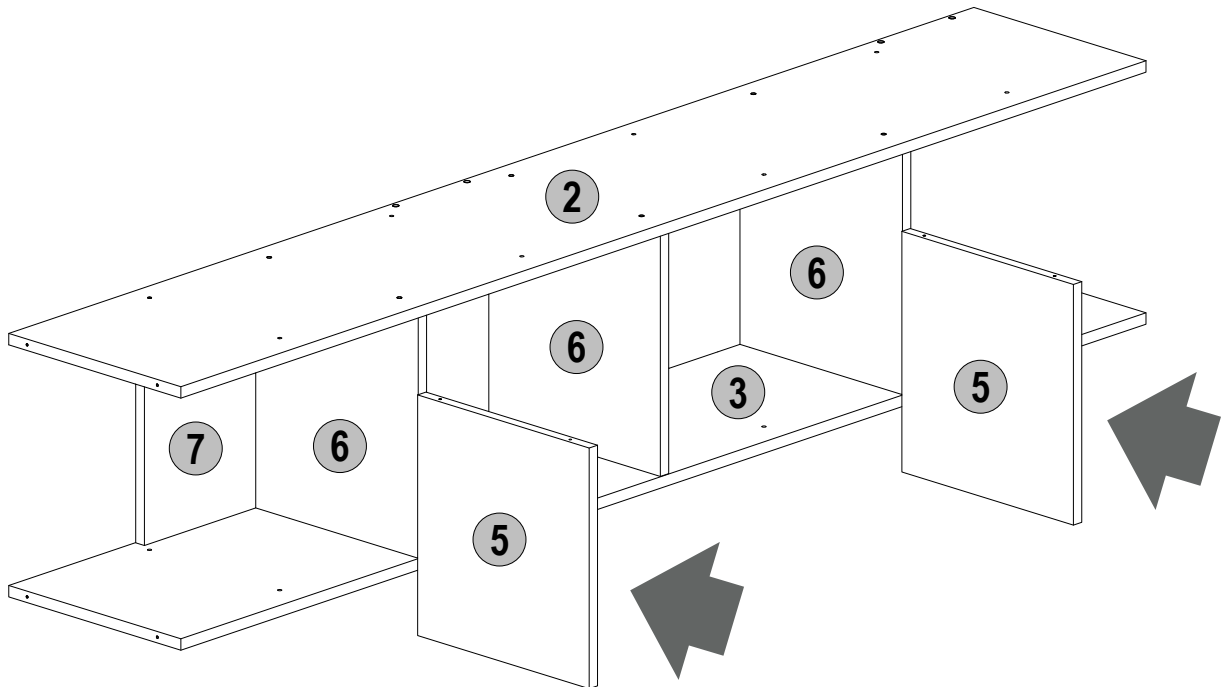

6

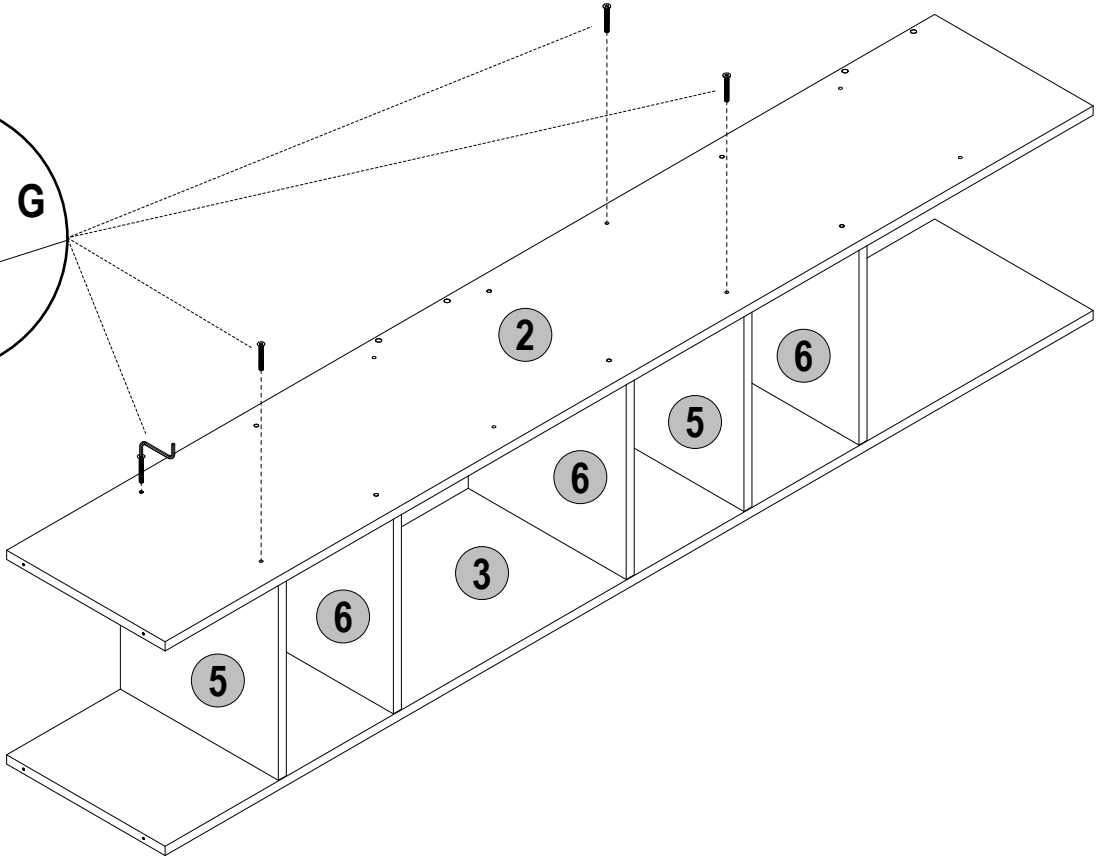
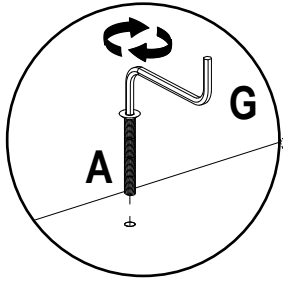
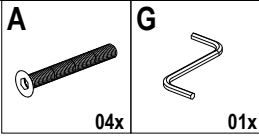

7

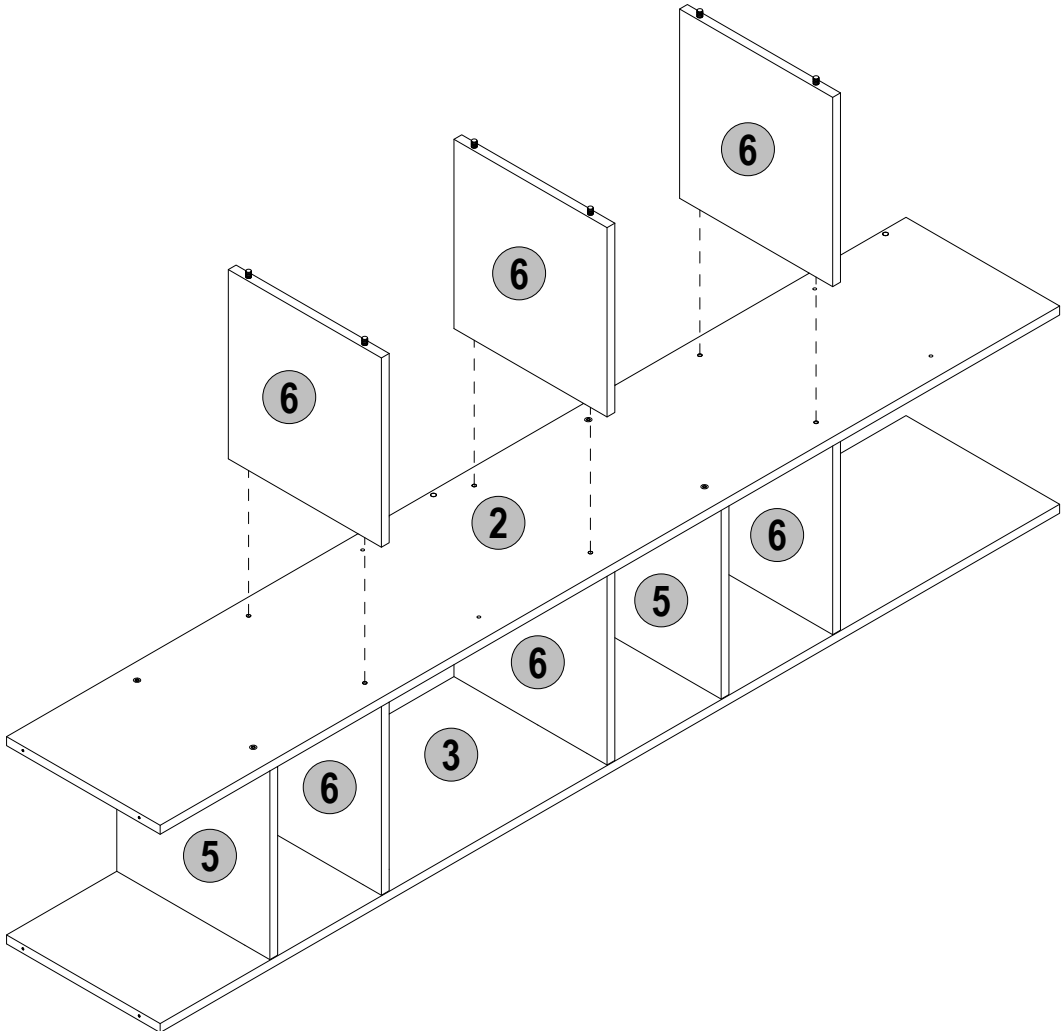

8

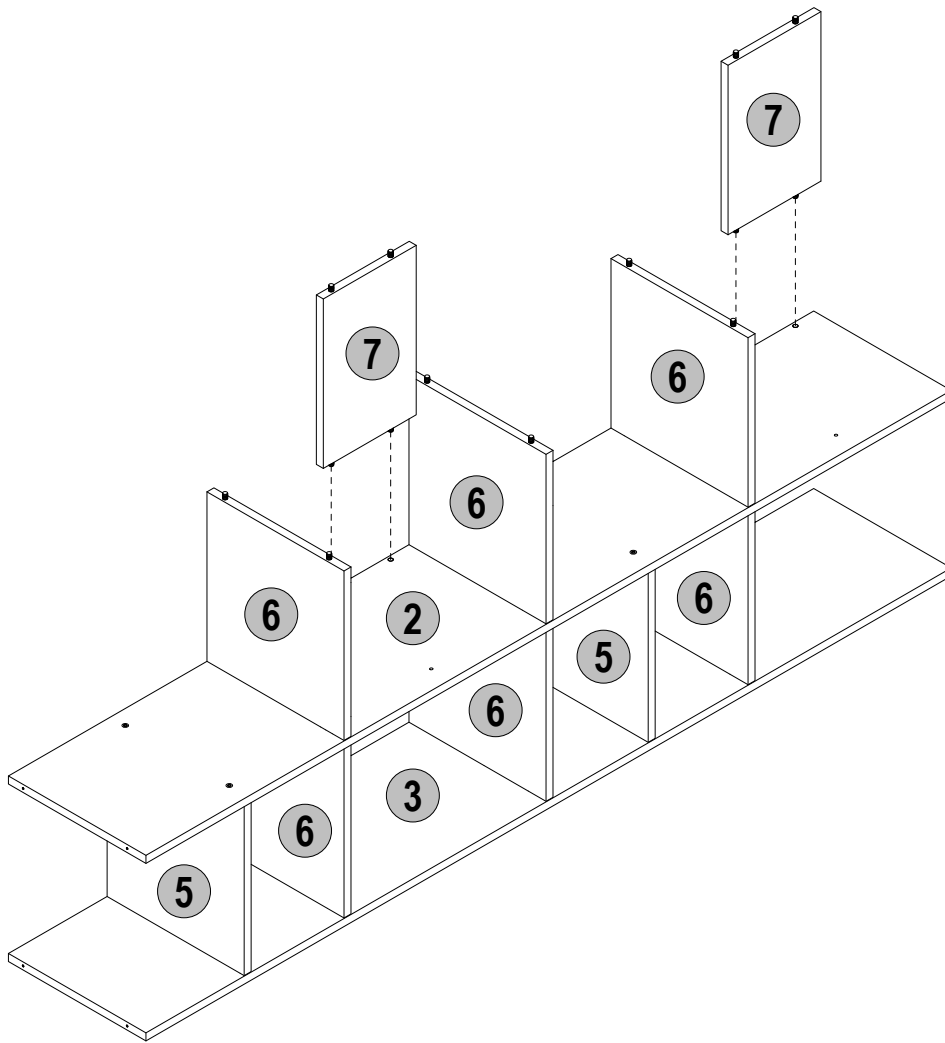

9

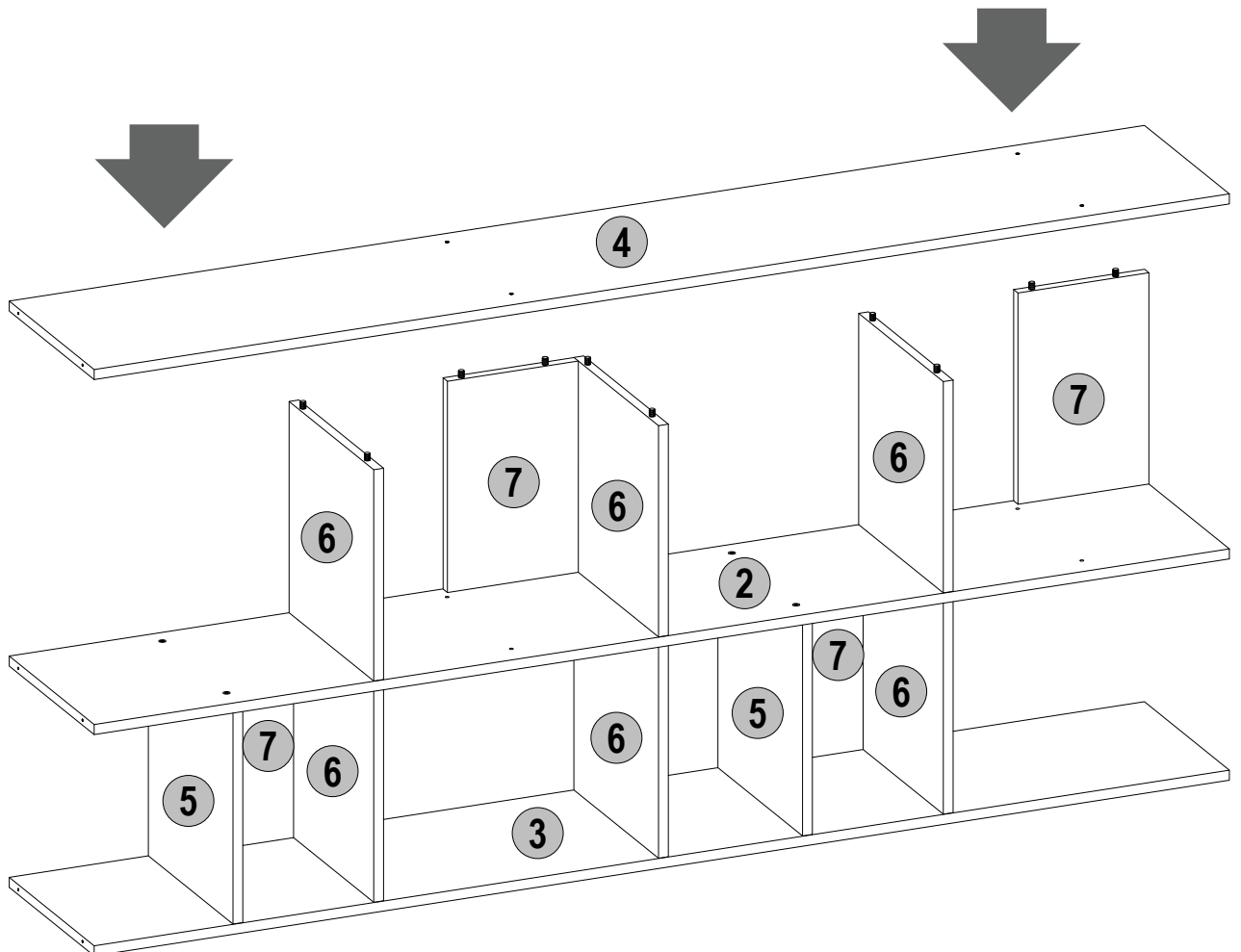

10

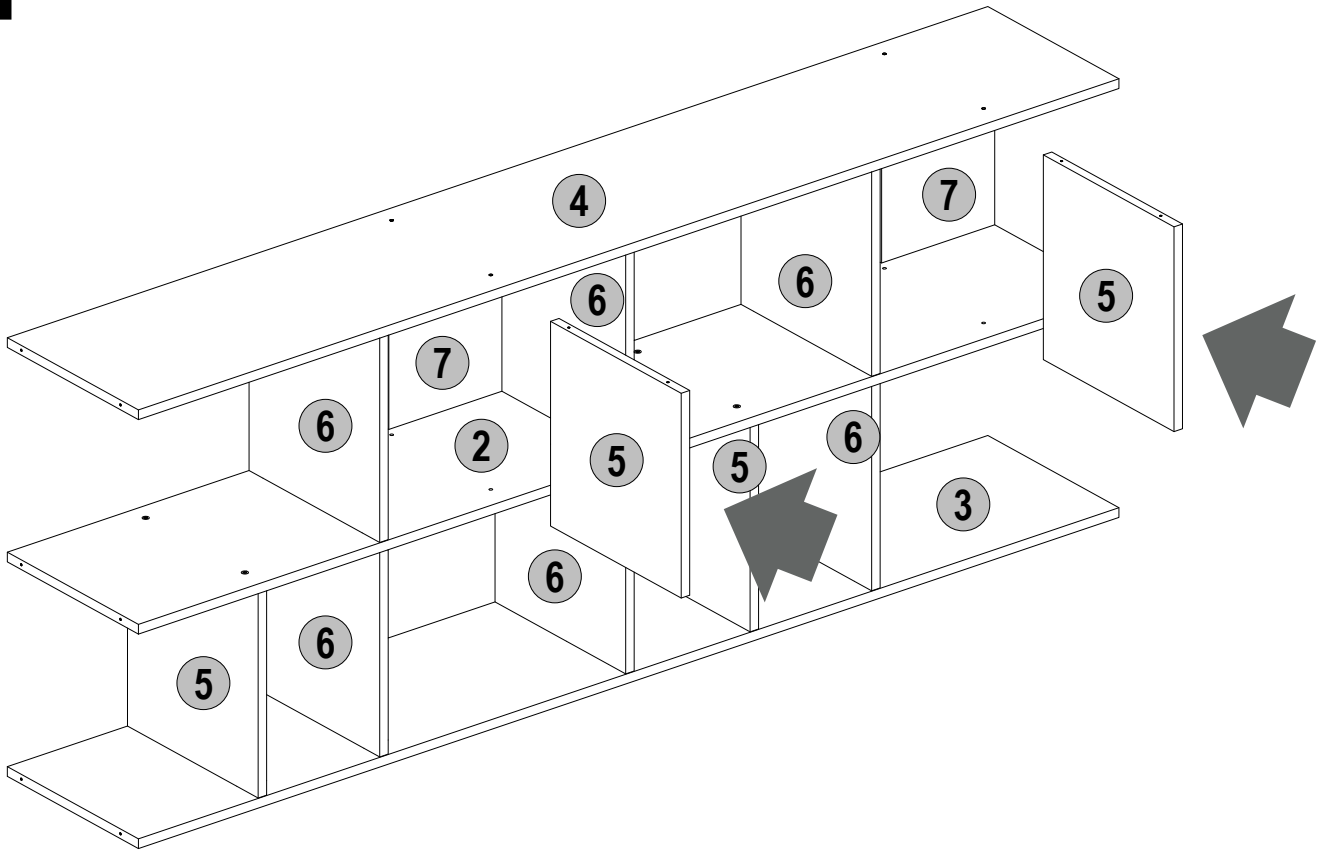

11

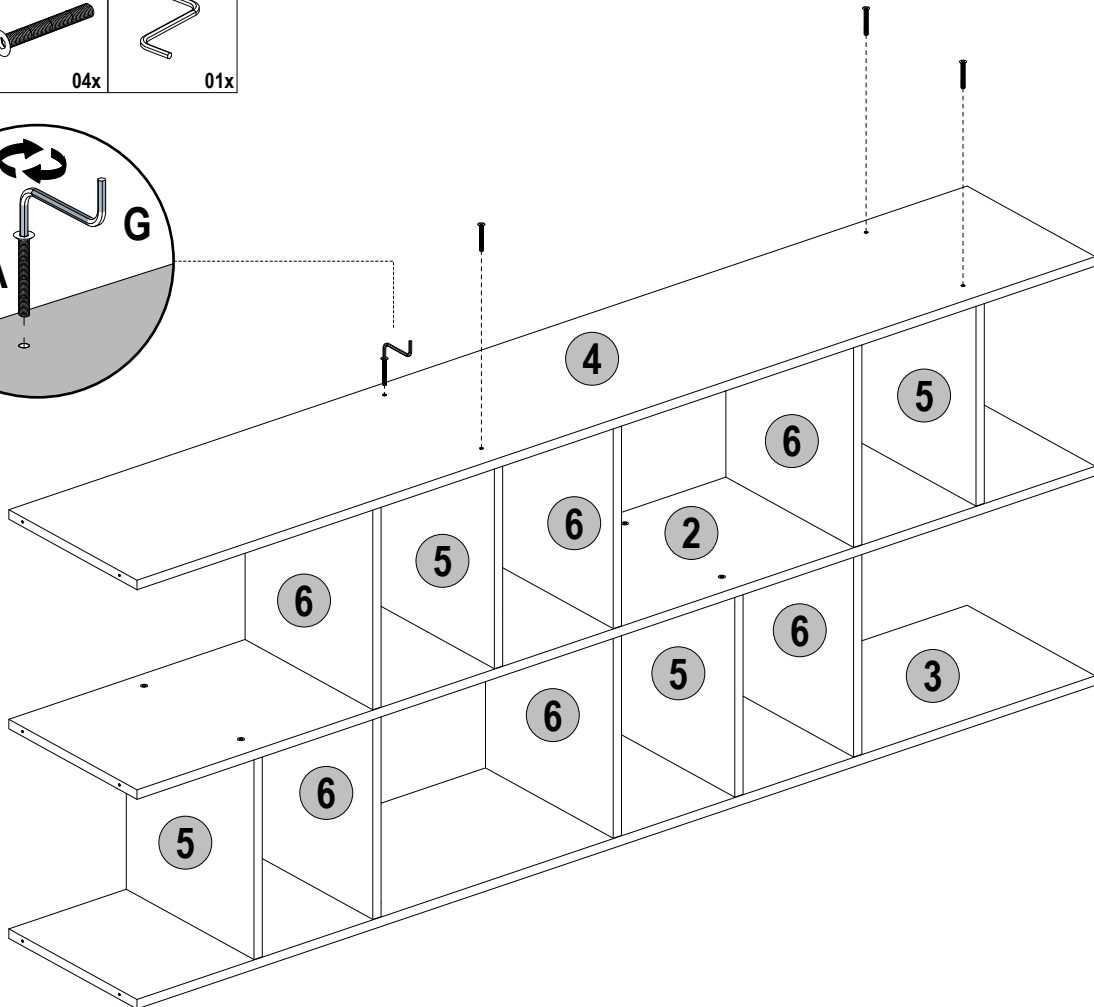
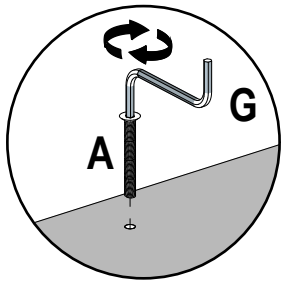
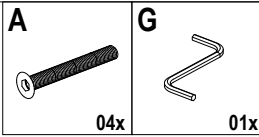

12

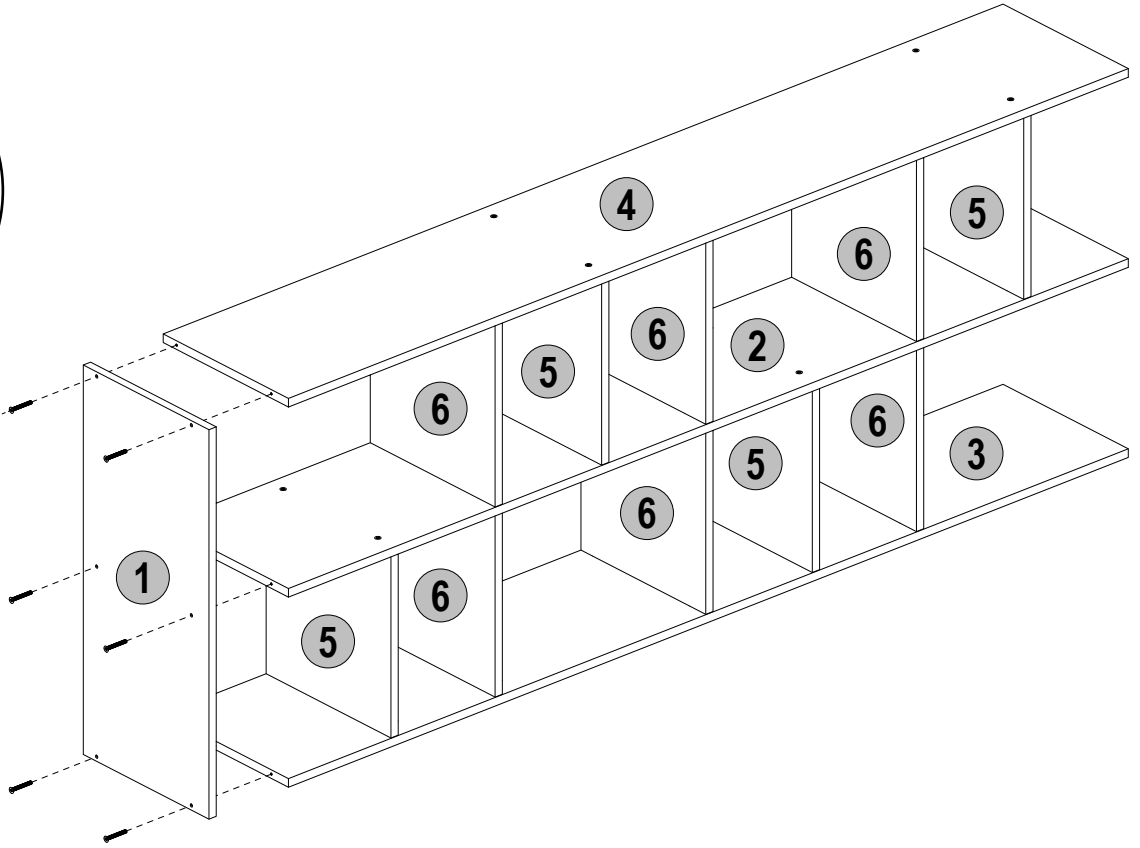
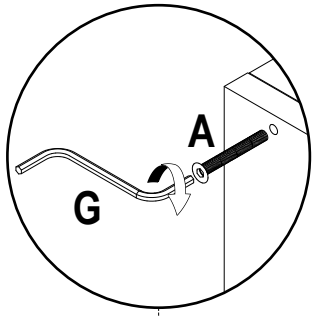
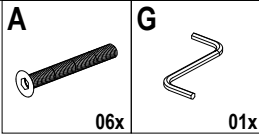

13

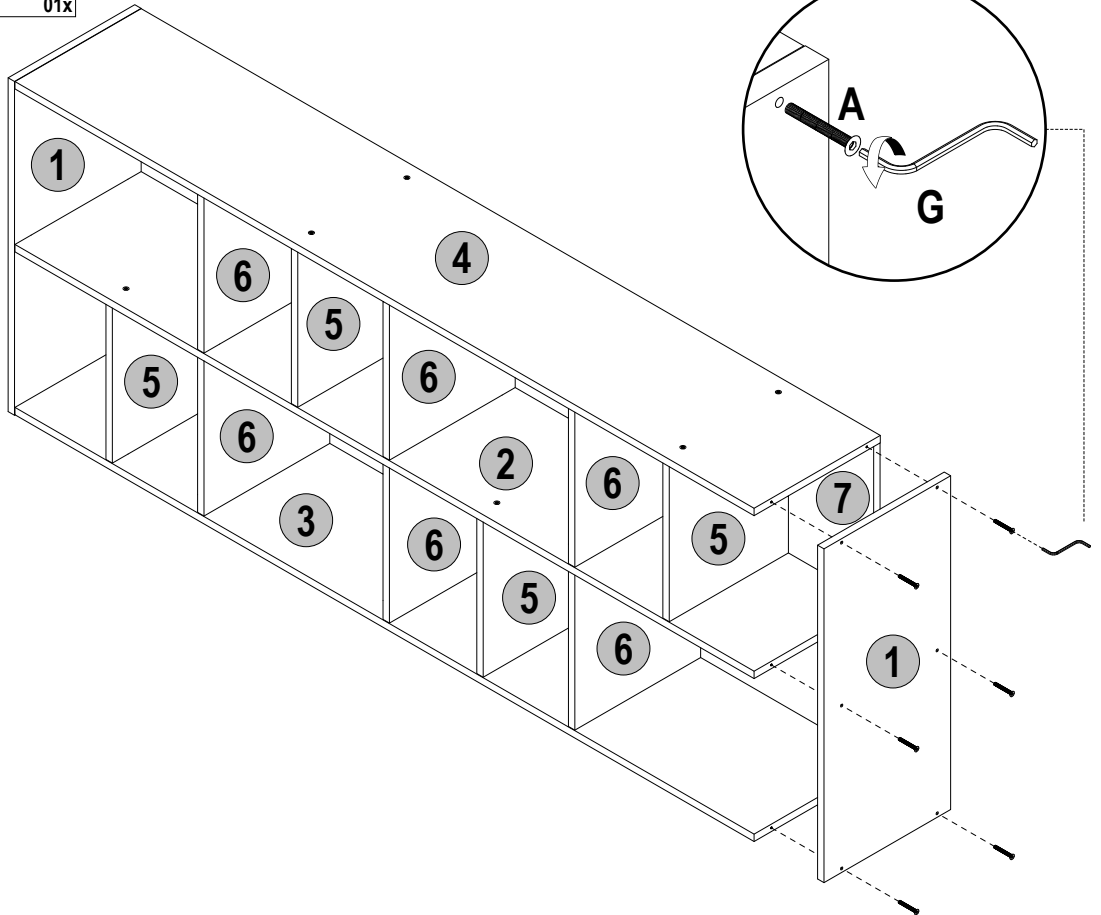
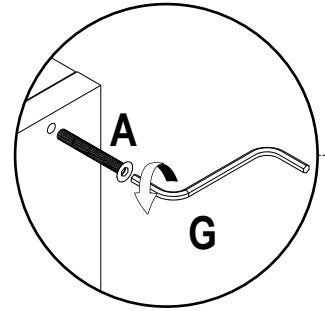
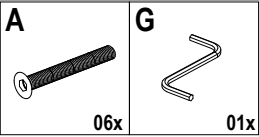

14

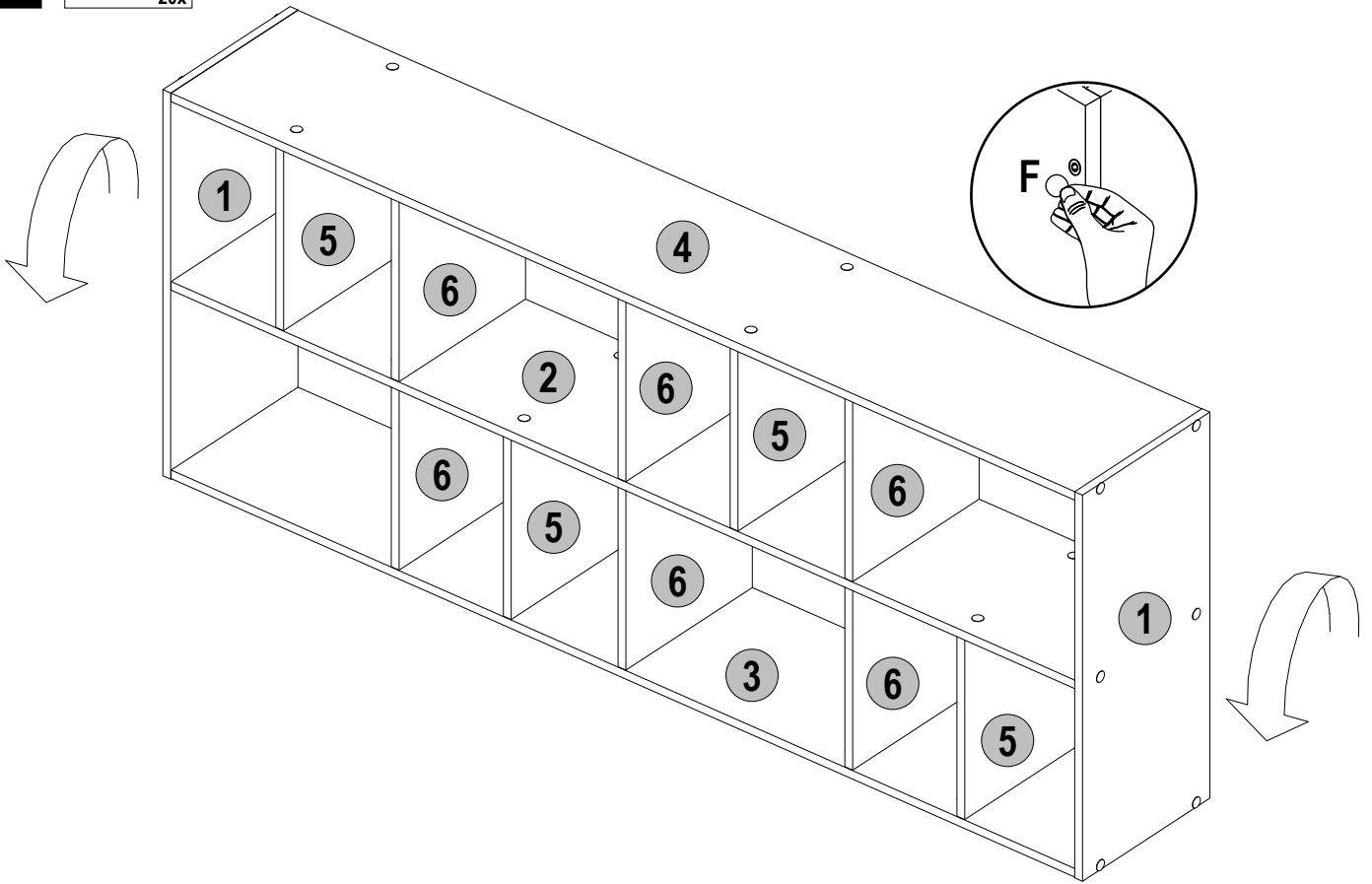
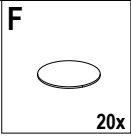

15

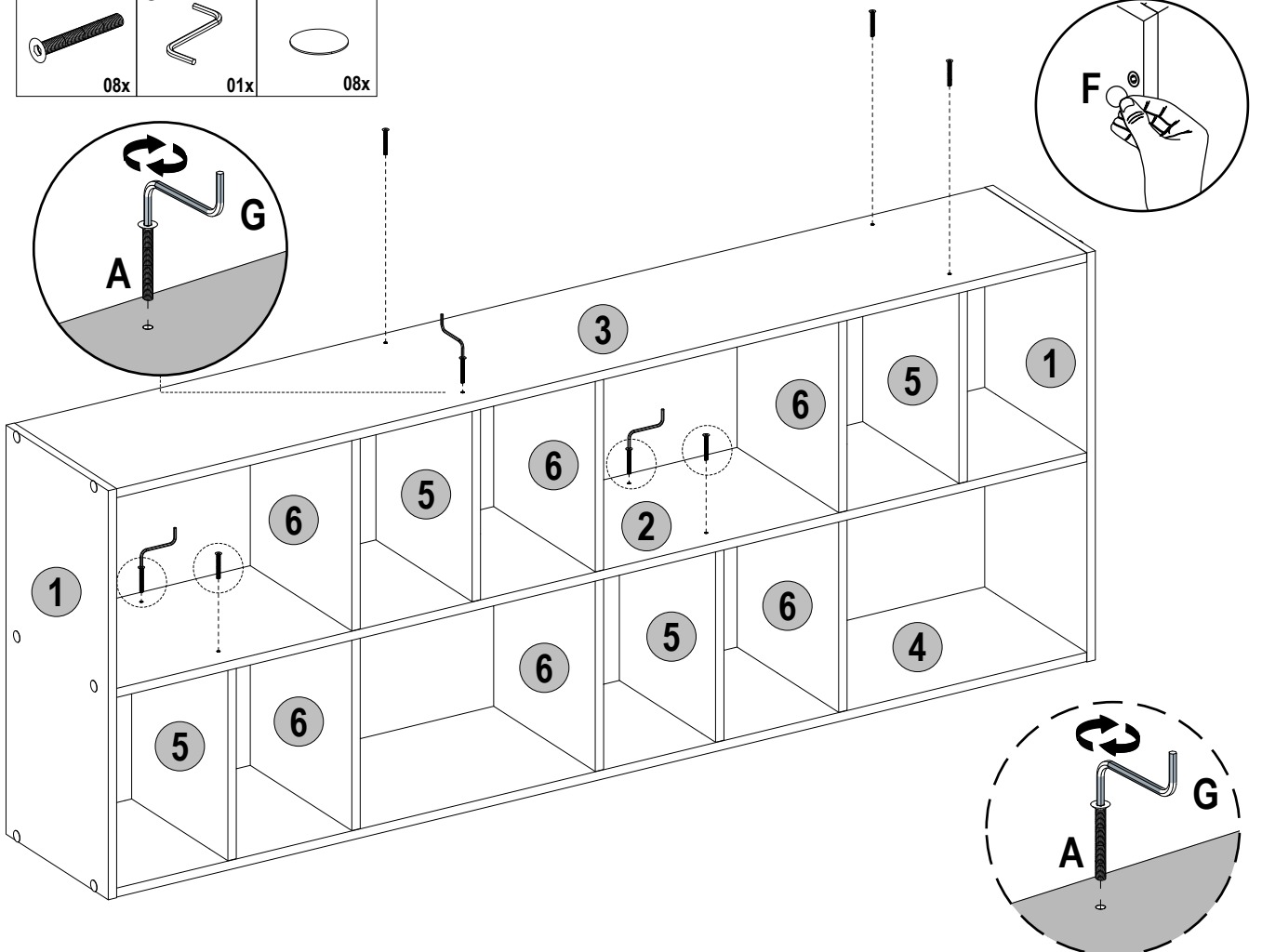
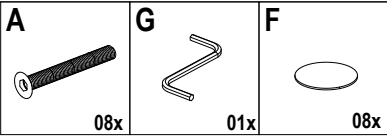

16

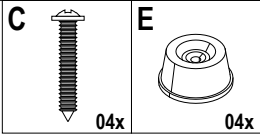

"OPTION 01"

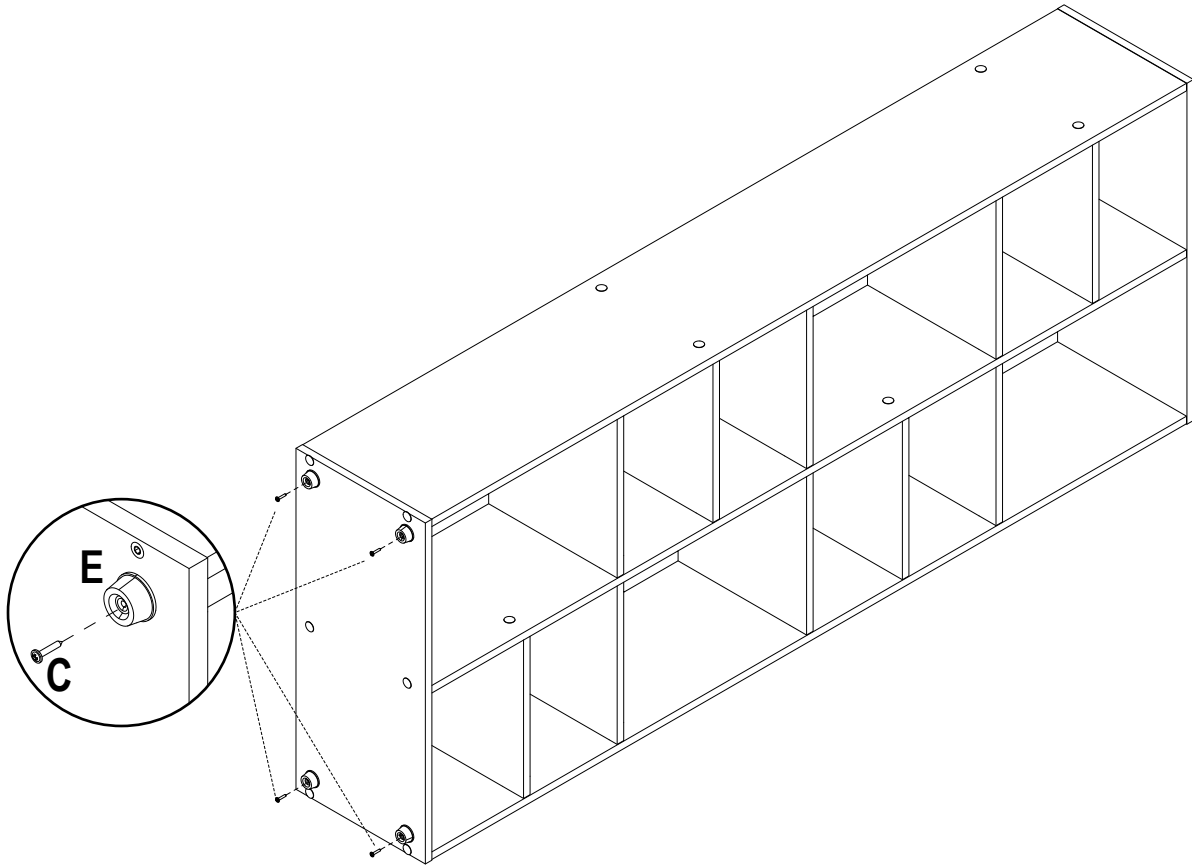

17

"OPTION 01"

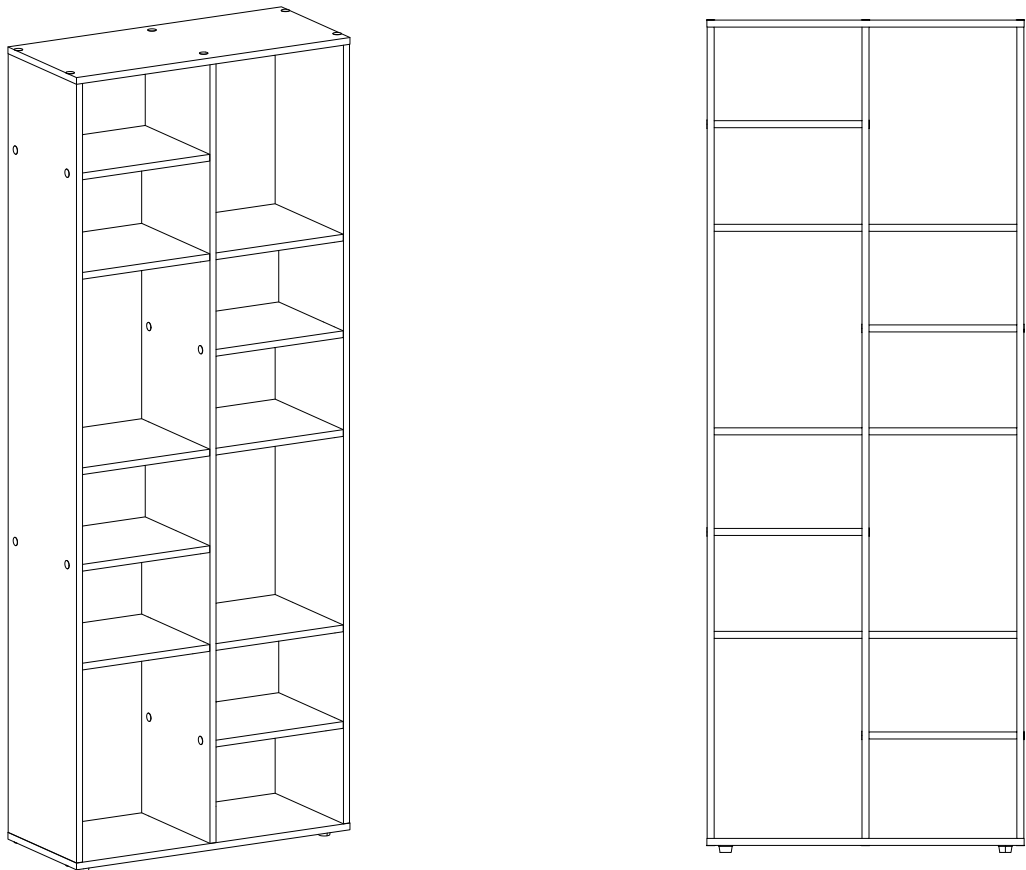

18

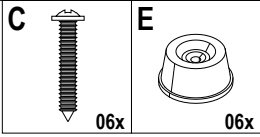

"OPTION 02"

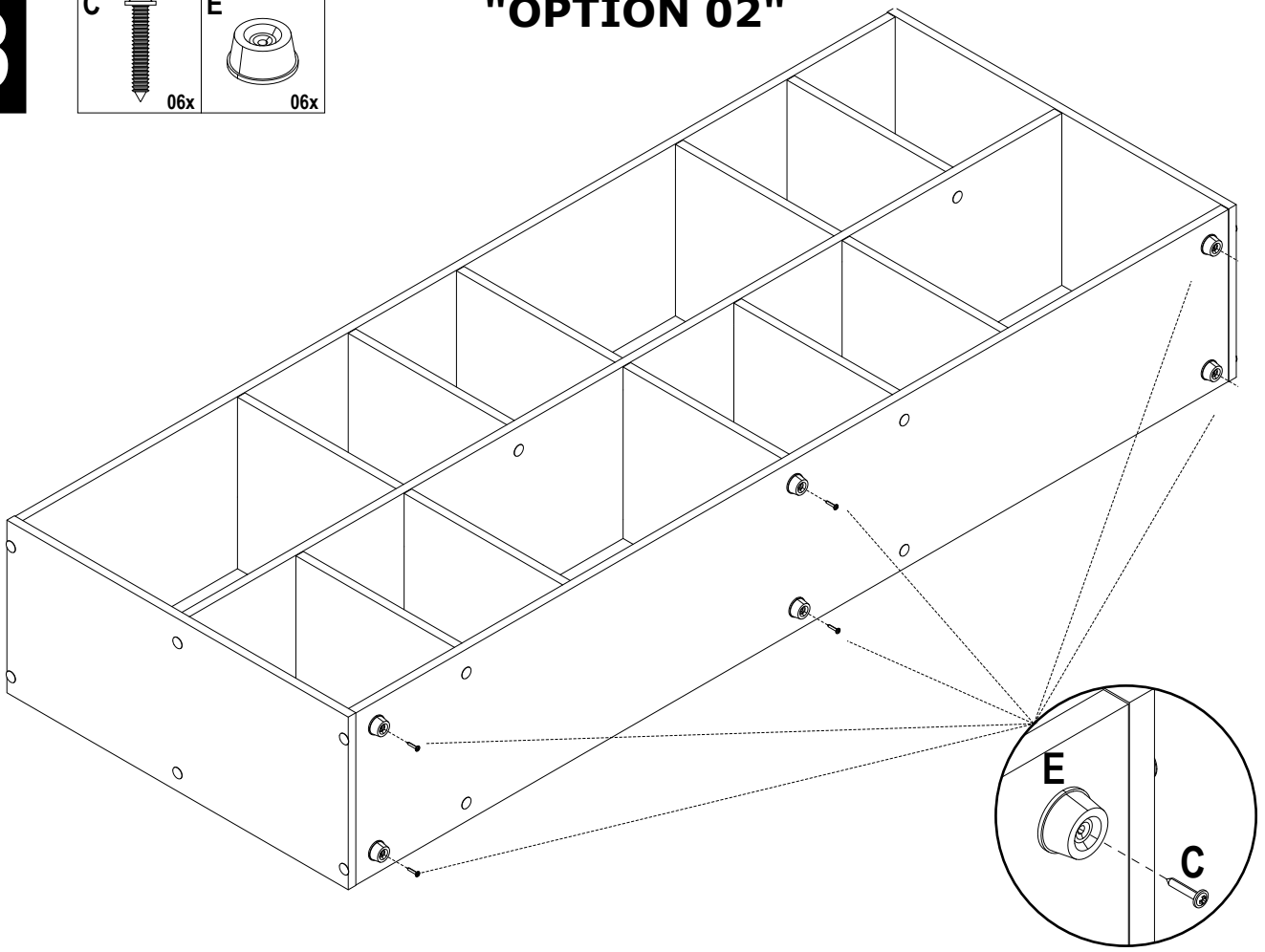

19

"OPTION 02"

