

Warranty

We offer a one-year warranty for the light fixtures

Our warranty ensures that any issues related to the performance or functionality of the light fixtures will be addressed and resolved promptly.

Our dedicated customer service team is available 24 hours a day to assist you. If you have any questions or concerns, we guarantee a response within 24 hours. During the warranty period, if you encounter any problems or need assistance, please don't hesitate to reach out to us via email. To ensure a swift and accurate resolution, kindly provide your order ID and detailed information regarding the issue.

Important Note: Please use this light fixture only for its intended purpose and avoid retrofitting or remodeling it. The warranty does not cover failures caused by third-party products or natural disasters.

[E-Mail:Lighting@yxtservice.com](mailto:Lighting@yxtservice.com)

INSTALLATION INSTRUCTION

DSMZ31013/2

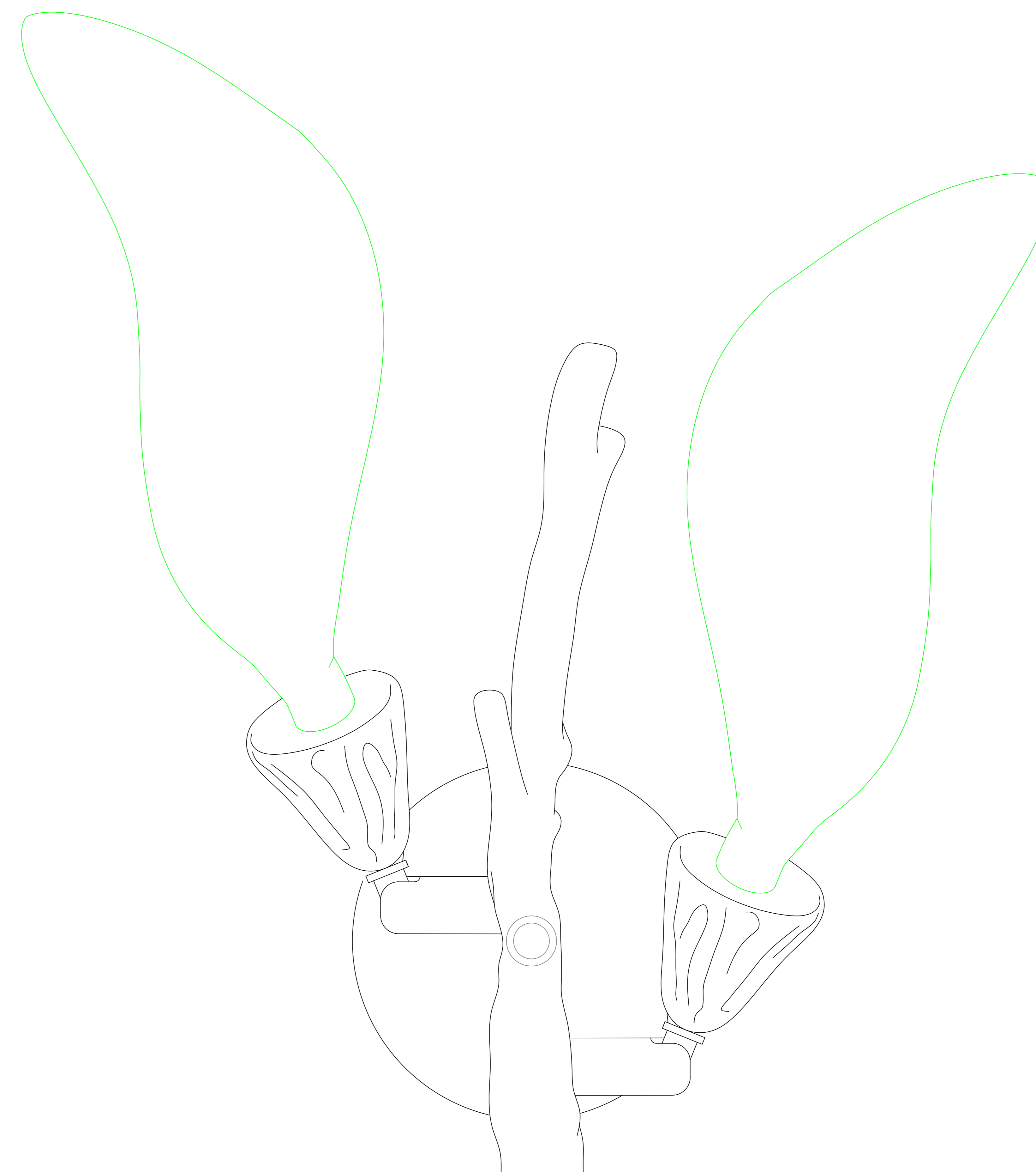

PACKAGE CONTENTS

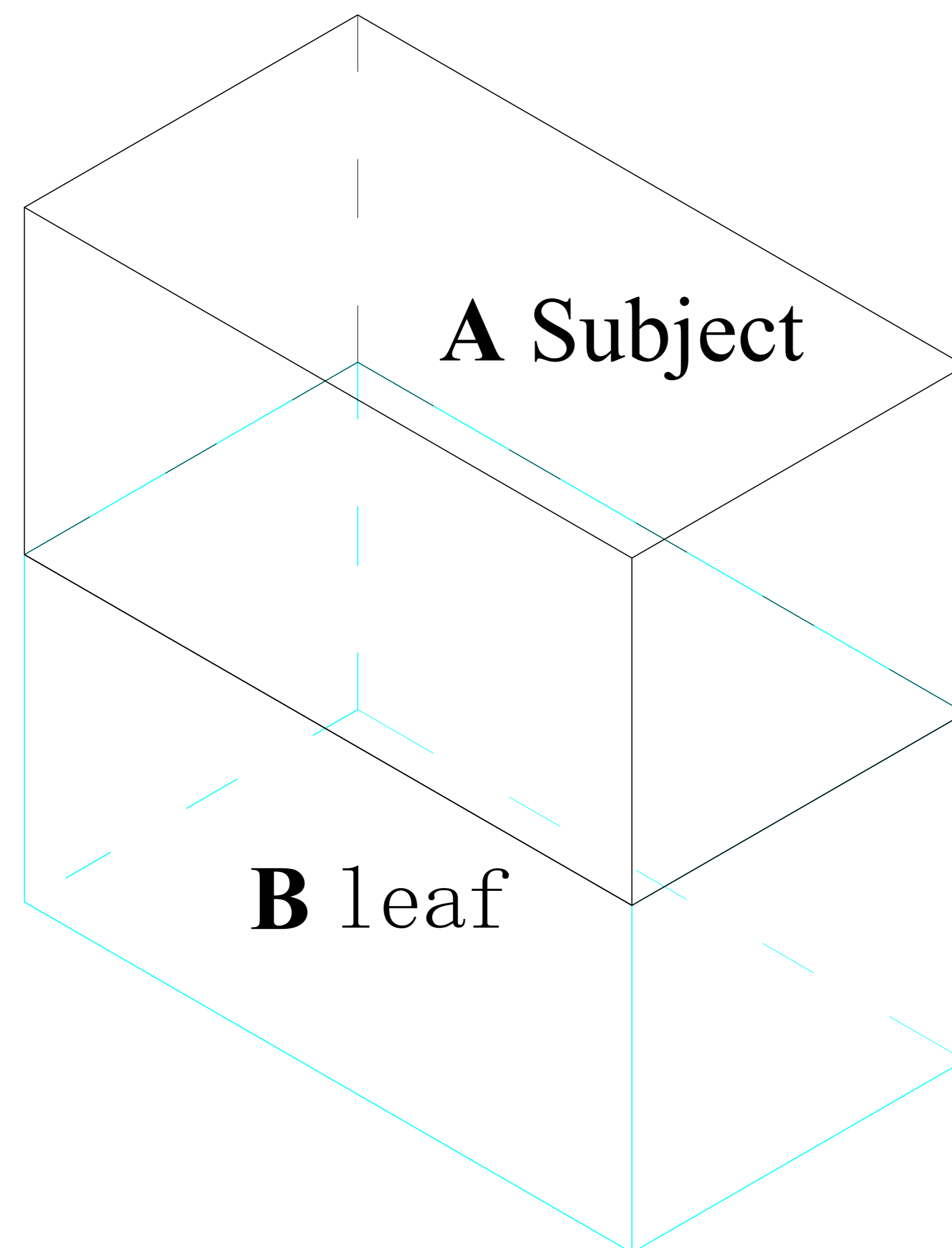

SAFETY INFORMATION

It is important to thoroughly read and understand the entire manual, before assembling, operating, or installing the product,

WARNING

- TURN OFF ELECTRICITY before installation, changing bulbs, or cleaning the light fixture.
- This fixture requires **2** pieces **LED** bulbs(not included in the product), the maximum wattage for each bulb is 3W, please do not exceed the recommended wattage.
- A QUALIFIED ELECTRICIAN IS RECOMMENDED FOR INSTALLATION.
- Do not use corrosive substances such as gasoline or alcohol disinfectants to wipe the lamps, otherwise it will damage the lamps.

PREPARATION

- Before installation, please make sure all the accessories are included (refer to the package content), if there is any part missing, please contact us at the order page, we will arrange the replacement in a timely manner
- **2** pieces of **LED** bulbs(Max. 3W) are required(not included in the product)
- For any questions or inquires, please feel free to contact us at the order page, our customer service team will reply ASAP.

Please note:
Please check the parts list, if the parts are missing during your actual installation, please contact us, we will help you in time!

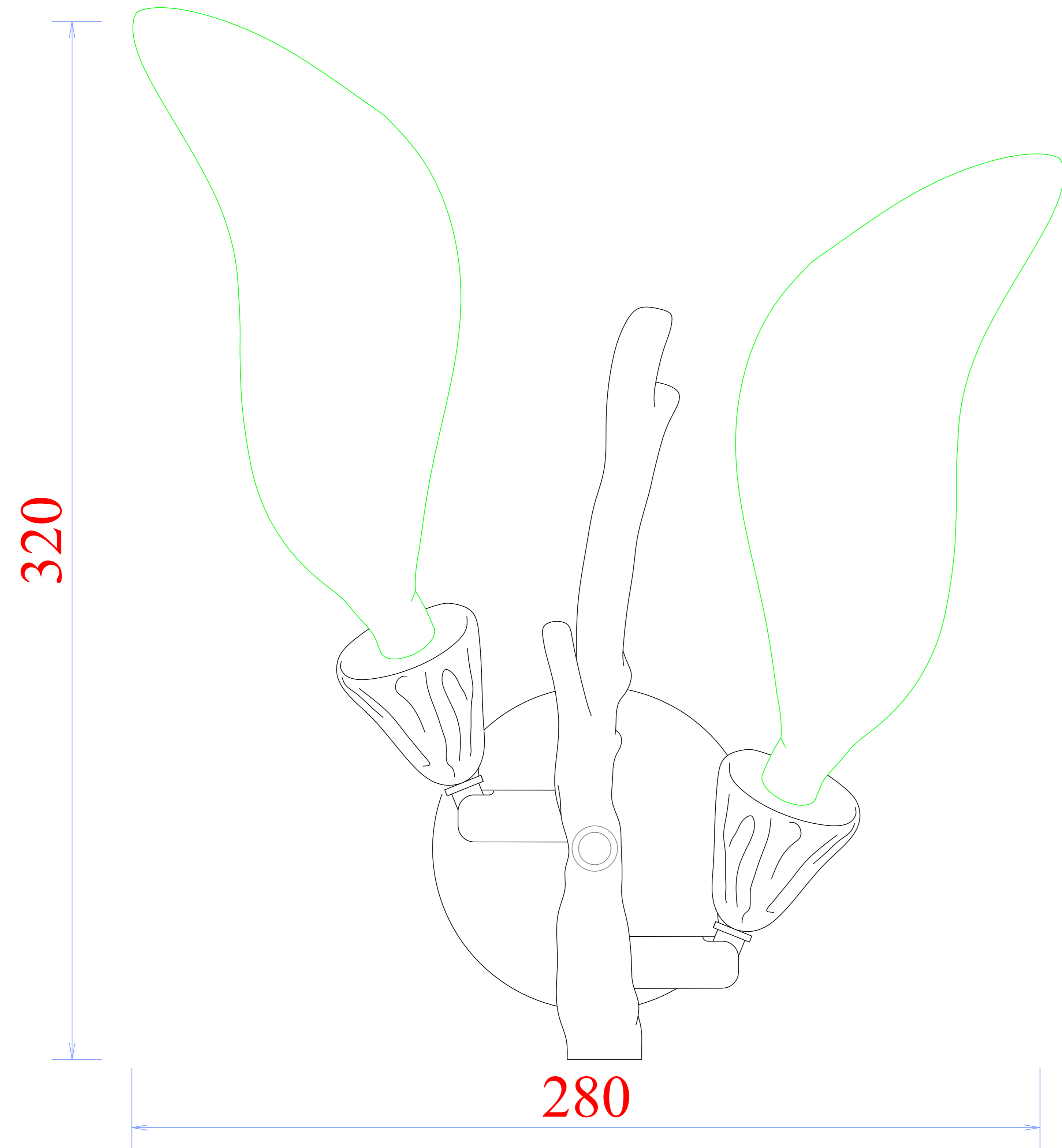

PACKAGE CONTENTS

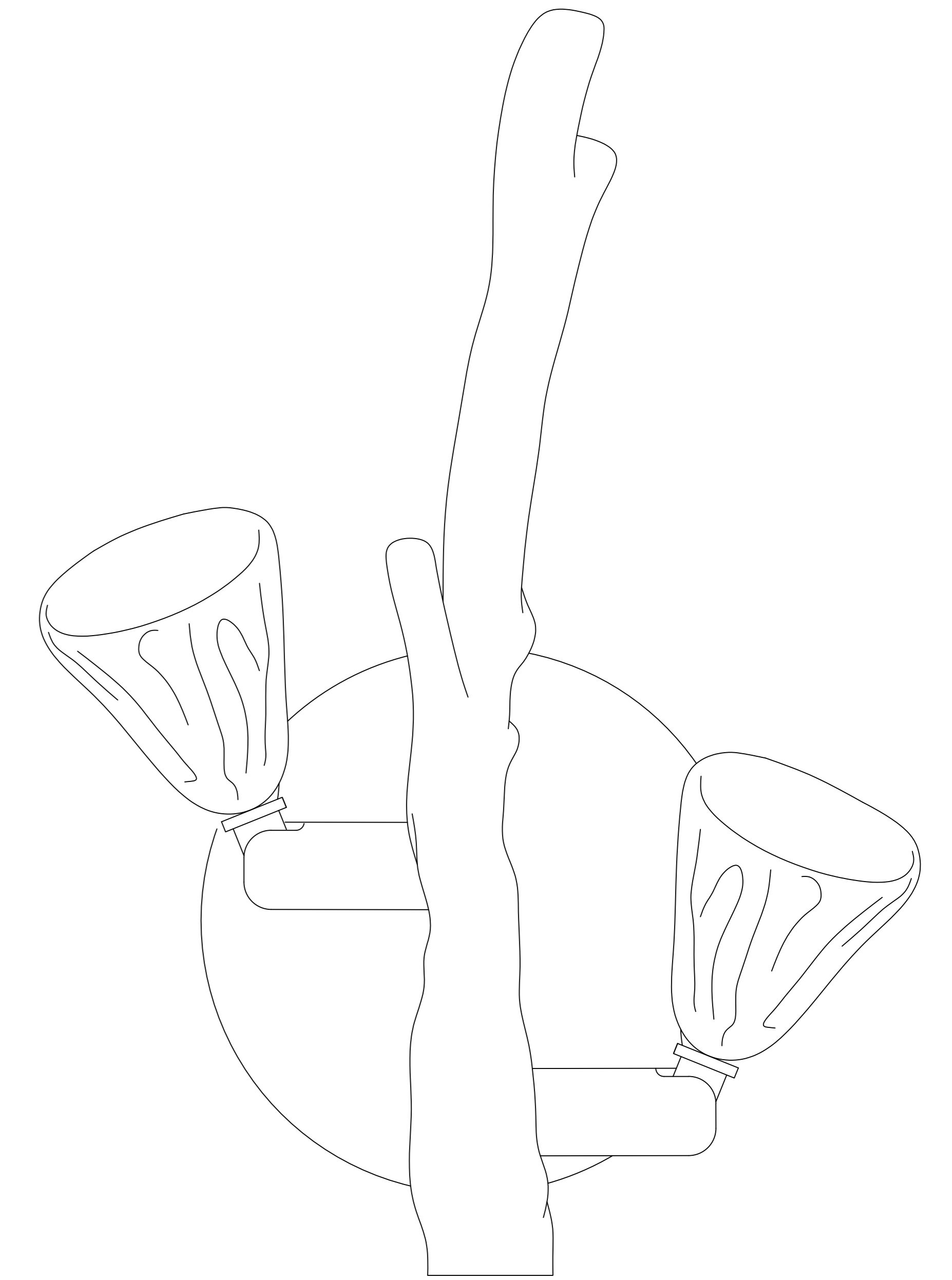
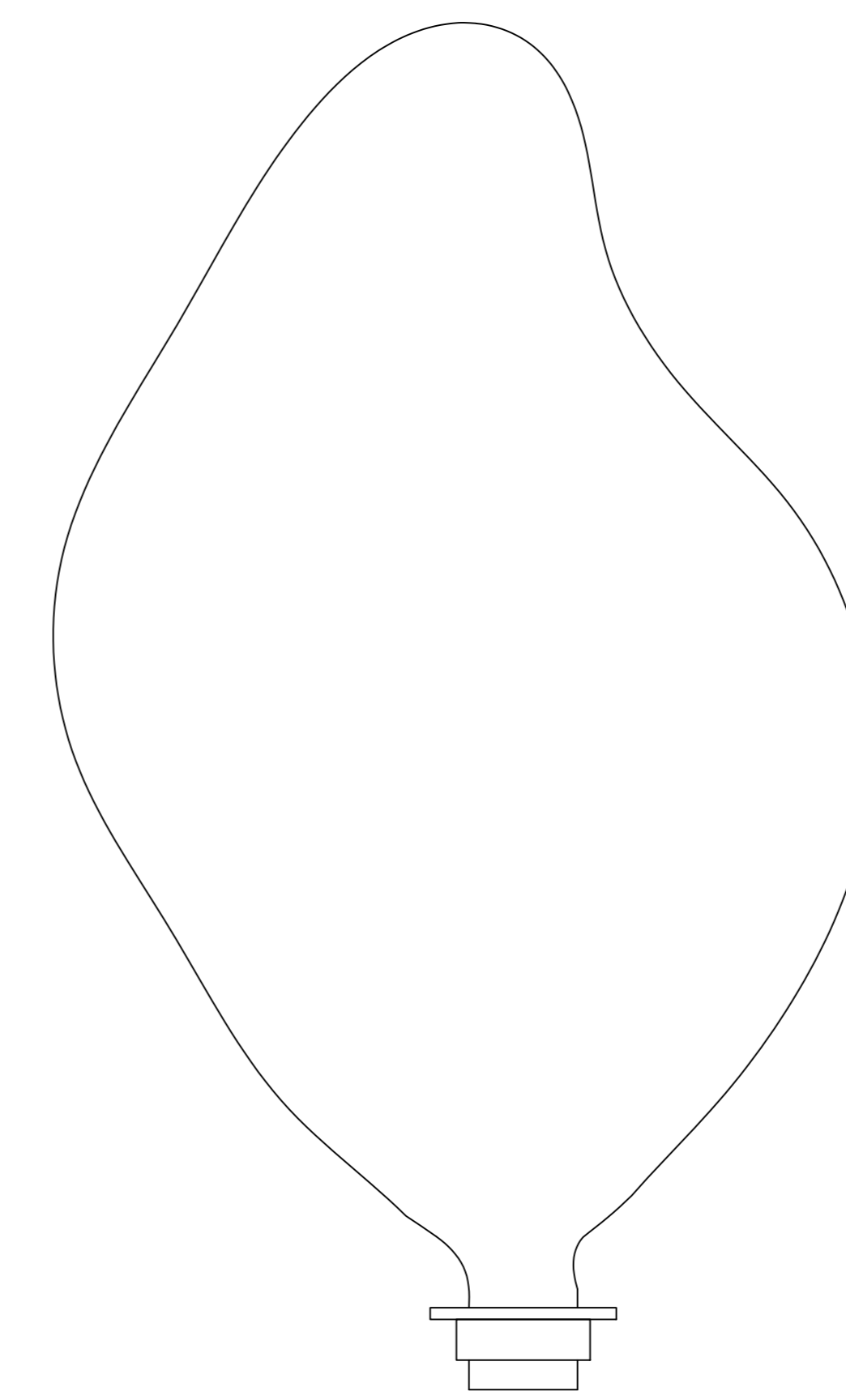
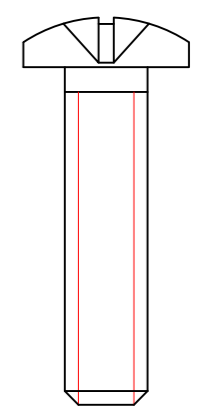
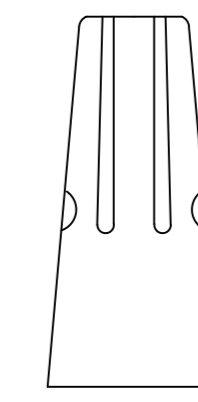
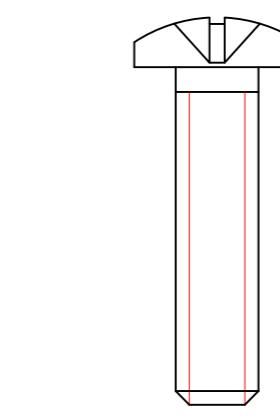
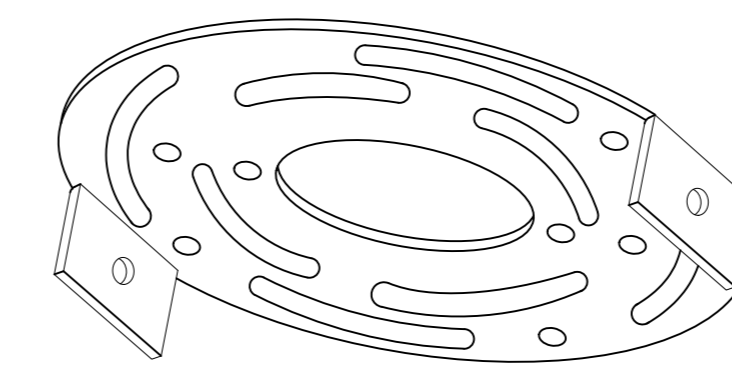

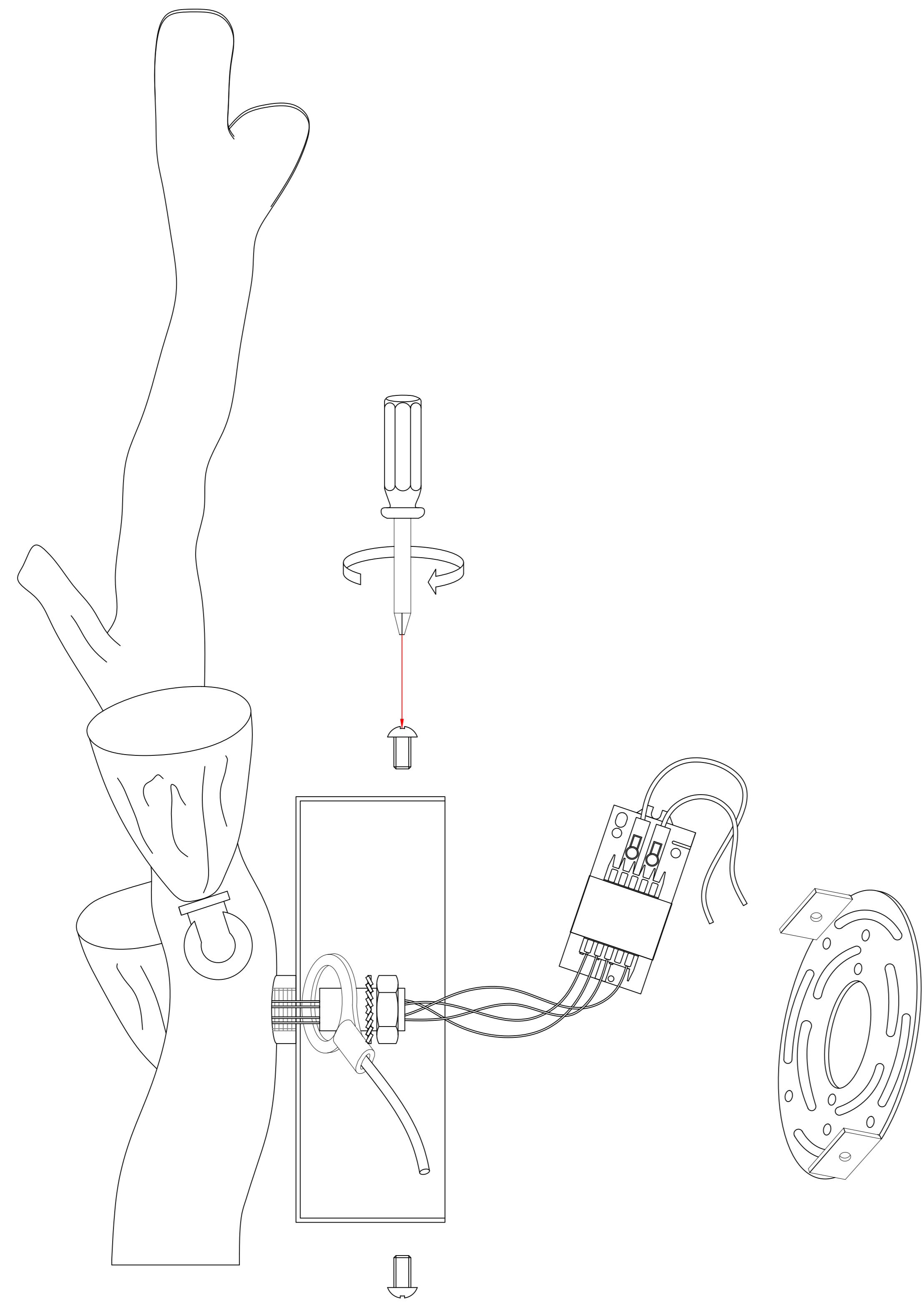

第一步：取下八卦挂板

Maintenance:

To ensure safe and efficient use of this product, please clean the lamp regularly (once a month). Before cleaning, turn off the power and wait for the lamp to cool to room temperature. Then use a soft cloth dipped in water and wrung dry to wipe it clean.

Please note:

Please check the parts list, if the parts are missing during your actual installation, please contact us, we will help you in time!

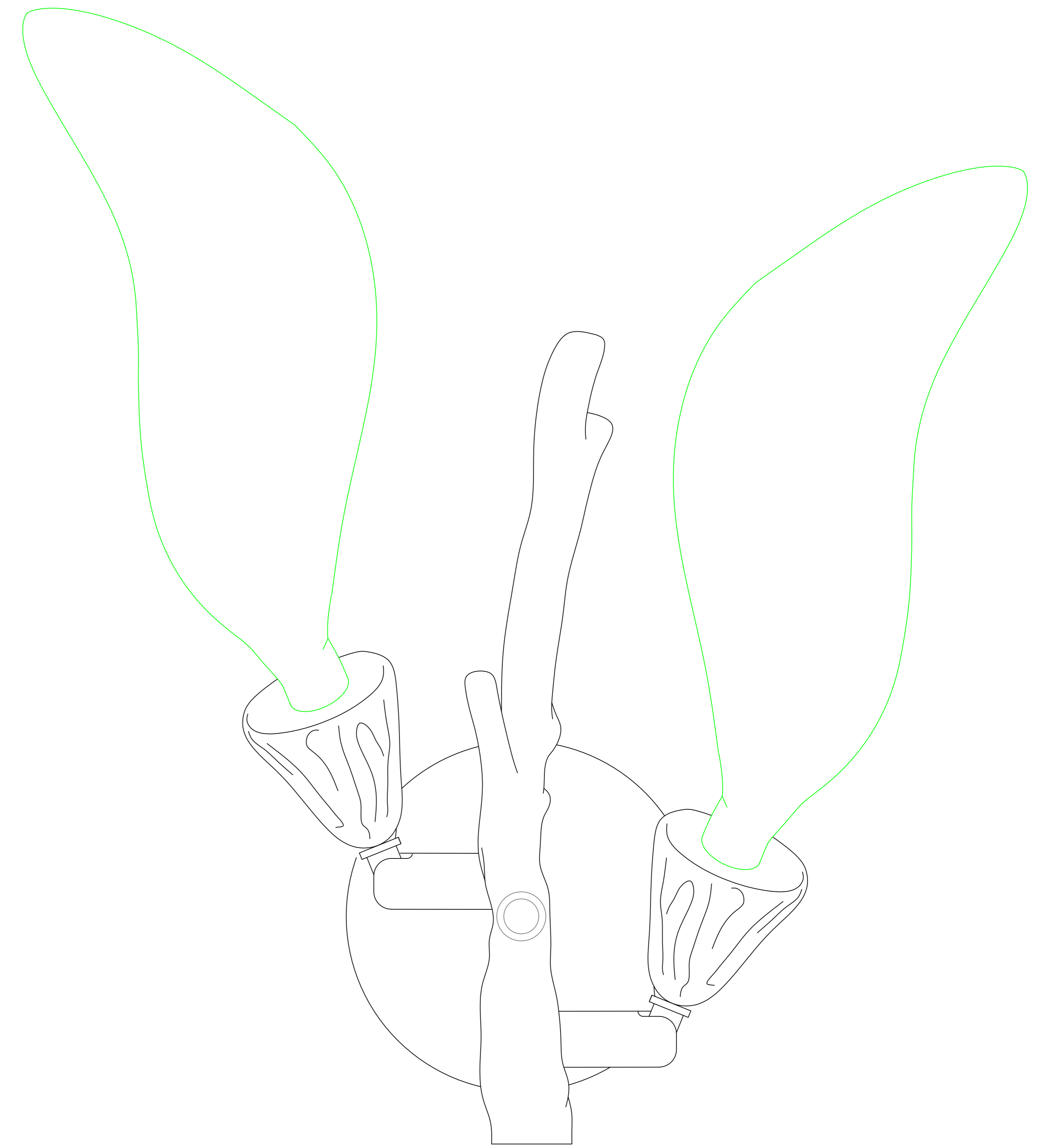



第三步：试亮，锁好固定叶片

Cautions.

- 1.This lamp can only be used indoors;
- 2.TURN OFF THE POWER BEFORE THE INSTALLATION IS FINISHED.

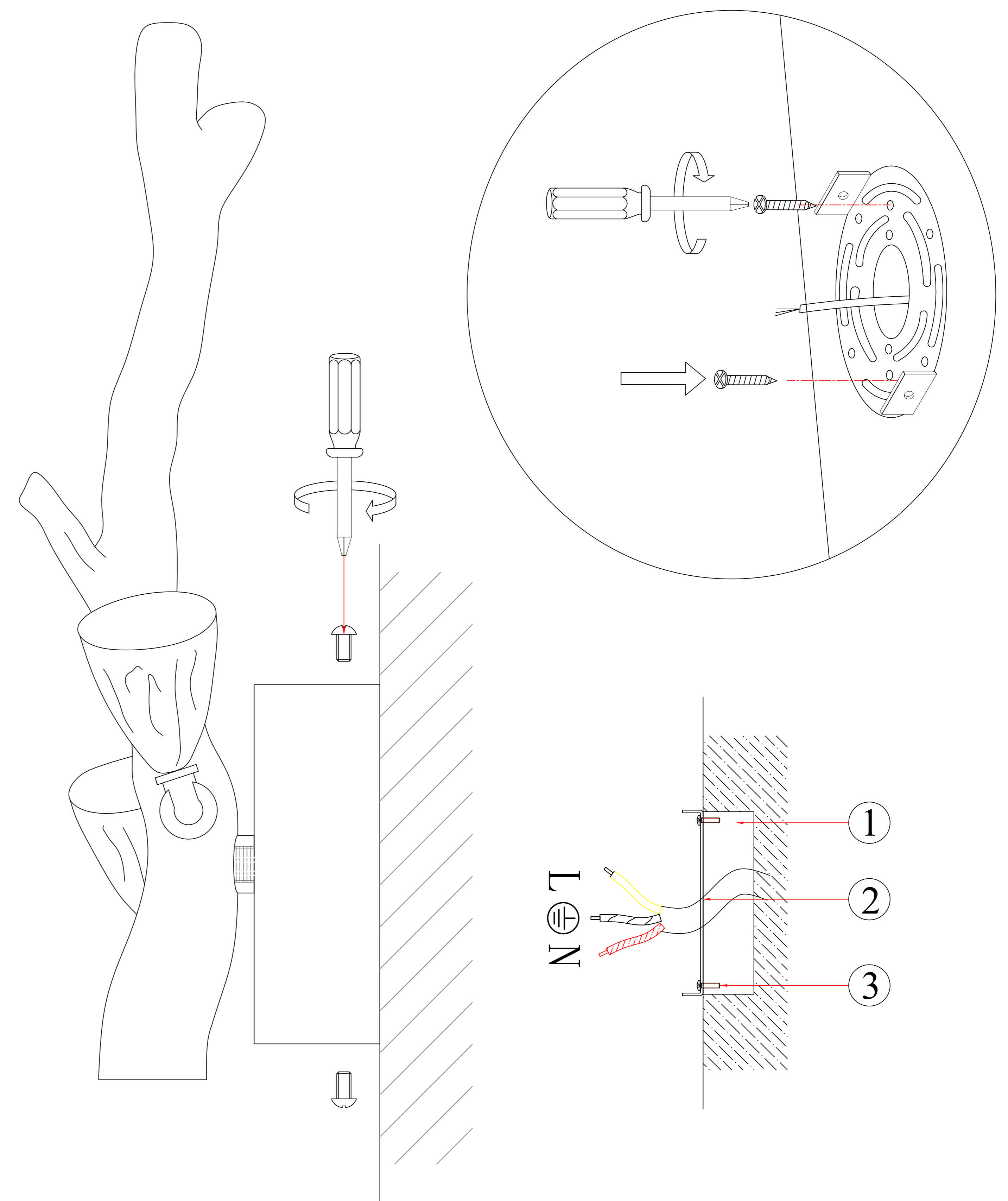

第二步：固定挂板, 正确连接电源线.

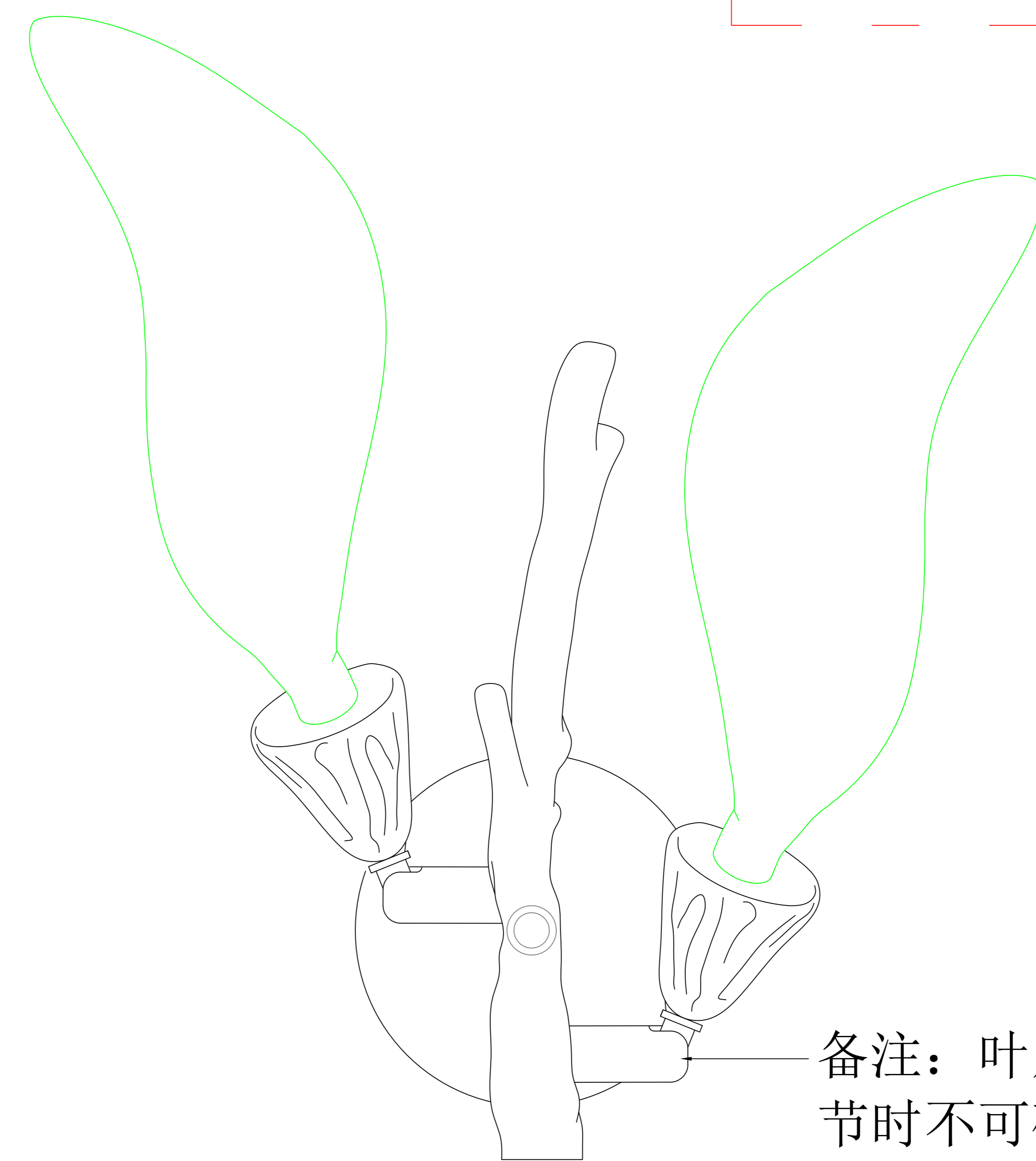
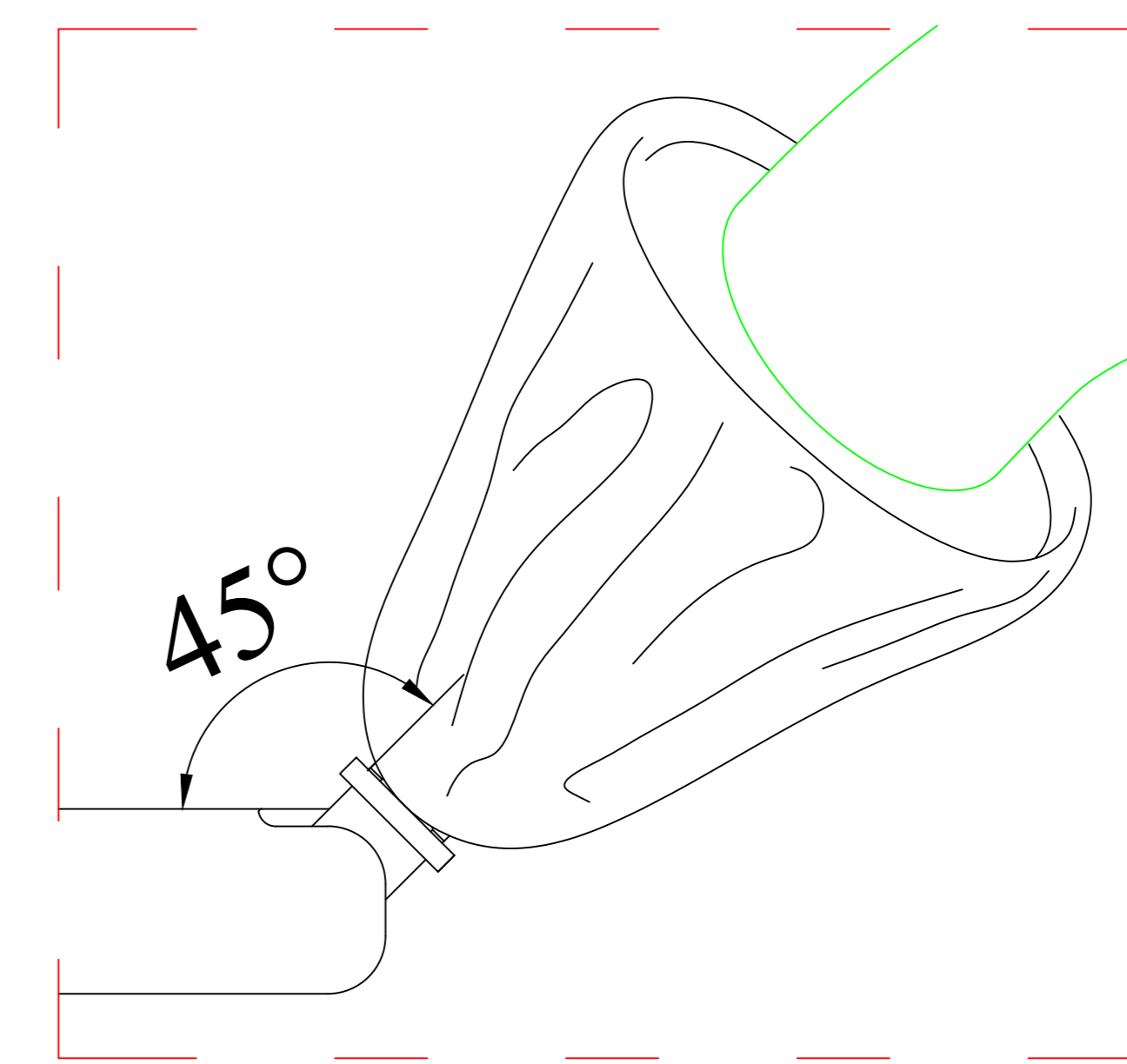

备注：叶片角度可调节45°，自行调节时不可碰到五金。

第四步：现场自行调节叶片角度，点亮。安装完成