









USER'S MANUAL
Textilene Furniture





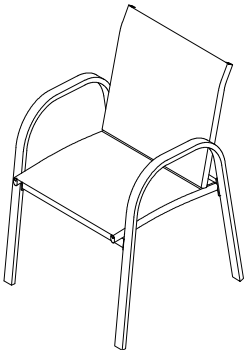
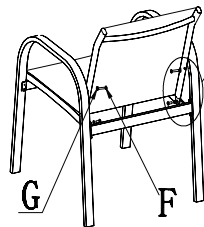
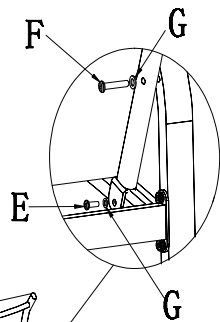
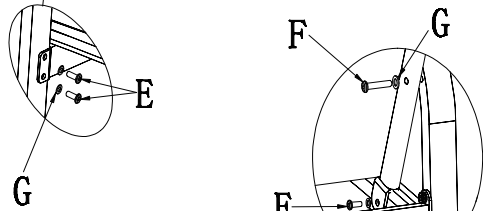
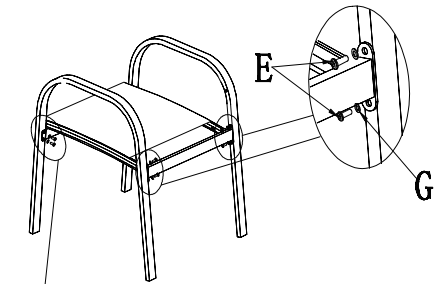
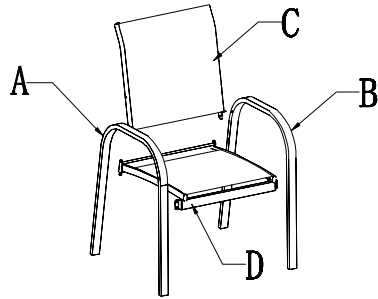

THIS INSTRUCTION BOOKLET CONTAINS **IMPORTANT** SAFETY INFORMATION. PLEASE READ AND KEEP FOR FUTURE REFERENCE.

Before You Start



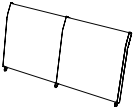
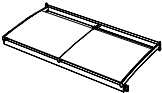

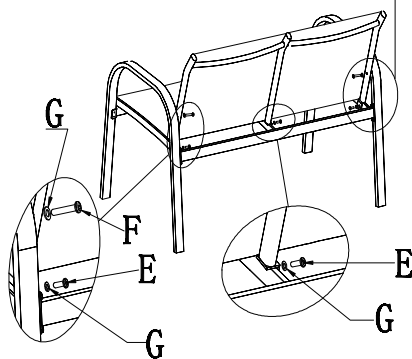
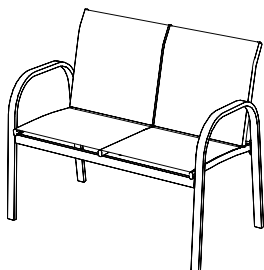
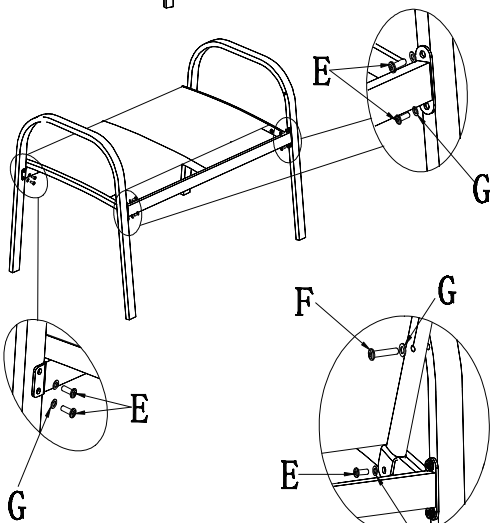
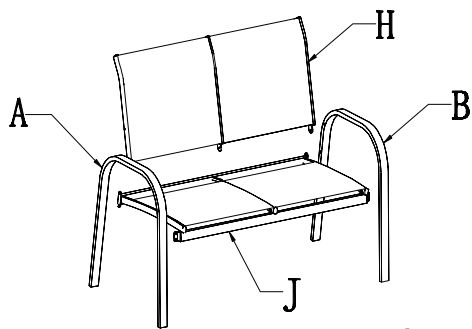

- ⚠ Please read all instructions carefully.
- ⚠ Retain instructions for future reference.
- ⚠ Separate and count all parts and hardware.
- ⚠ Read through each step carefully and follow the proper order.
- ⚠ We recommend that, where possible, all items are assembled near to the area in which they will be placed in use, to avoid moving the product unnecessarily once assembled.
- ⚠ Always place the product on a flat, steady and stable surface.
- ⚠ Keep all small parts and packaging materials for this product away from babies and children as they potentially pose a serious choking hazard.

A		2
B		2
C		2
D		2
E	 M6*16	10
F	 M6*30	2
G		12
		1

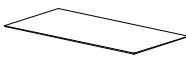

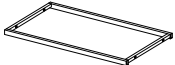
A		1
B		1
H		1
J		1
E	 M6*16	11
F	 M6*30	2
G		13
		1



K		1
L		2
M		1
E	 M6*16	4
F	 M6*28	4
G		8
		1

