

Mid-Century Modern Sofa

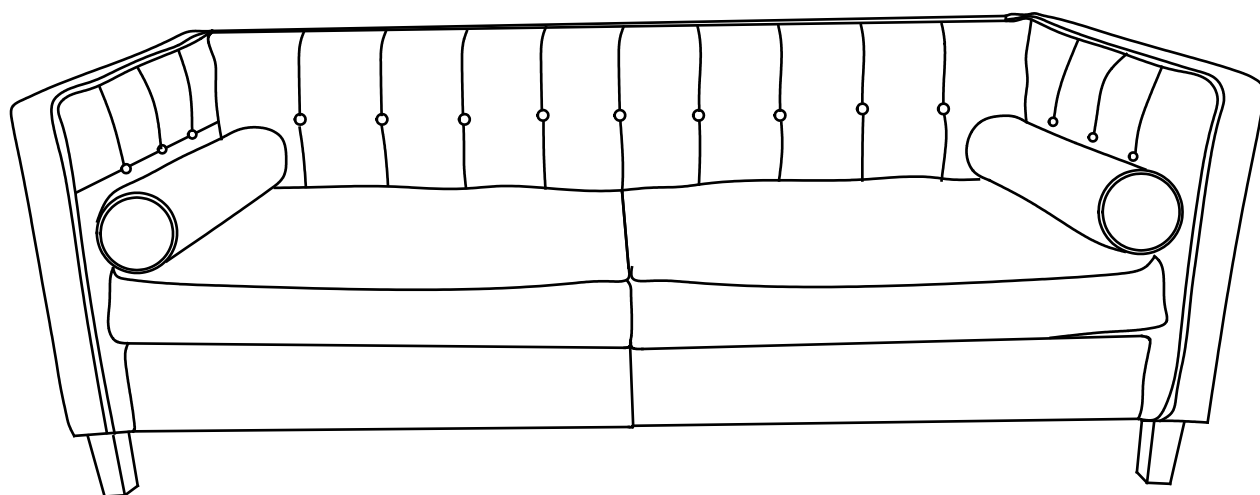

ASSEMBLY INSTRUCTIONS

Before you start...

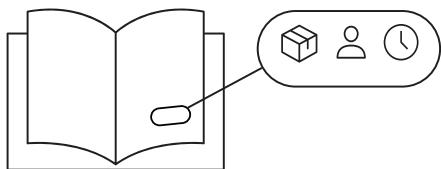

Ensure you have received all cartons and familiarize yourself with the workload. Make sure there are enough helping hands to assist you, and that you have allocated the time required to assemble your new product.

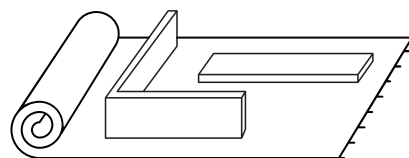

Make sure you have cleared enough space in your home for the assembly. We recommend protecting your floor with a mat or cardboard to avoid scratches during the assembly process.

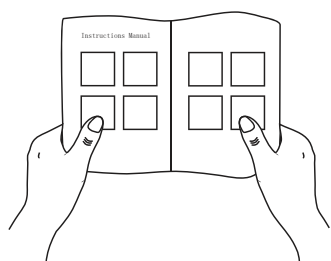

Read instructions carefully and check no parts are missing.

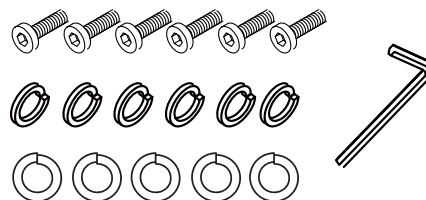

Lay out all hardware on a soft surface so you can easily identify them.

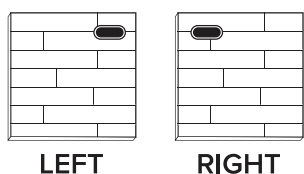

Carefully identify all components in order to differentiate which pieces are left and right.

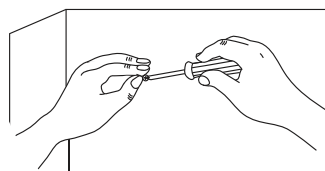

Install your new product carefully following the instructions. Don't skip ahead!

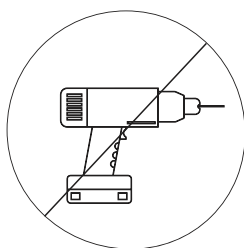



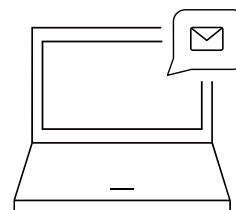







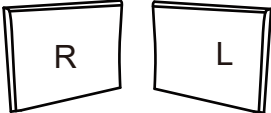
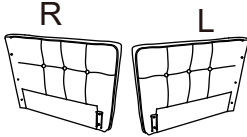

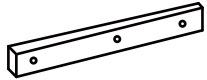
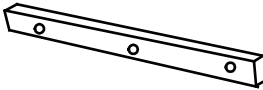
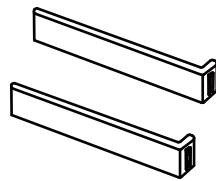
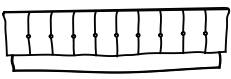

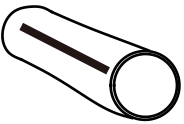
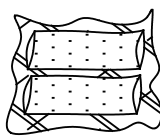
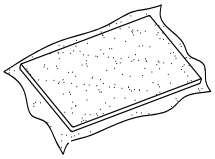
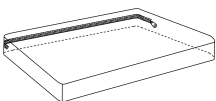
DO NOT over tighten screws or use a drill. It will damage the product.

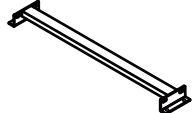

If you need further assistance with assembling your product, please chat with us.

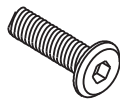
PARTS LIST

BOX1

Part	A-backrest	B-armrest	C	D	
Description					
Qty	1Pair	1Pair	4Pcs	1Pc	
Part	E	F	G	H	
Description					
Qty	2Pcs	4Pcs	1Pc	1Pc	
Part	I	J	K	M	N
Description					
Qty	2Pcs	2Pcs	1Pc	2Pcs	2Pcs
Part	O	P	Q	S	T
Description				ALLEN KEY 	M5*25 
Qty	2Pcs	1Pc	1Pc	1Pc	4Pcs
Part	U	V	W	X	Y
Description	M6*50 	M8*40 	M8*60 	M6*30 	8.5*17*2mm 
Qty	19Pcs	3Pcs	6Pcs	6Pcs	34Pcs

ASSEMBLY STEPS

Step1:

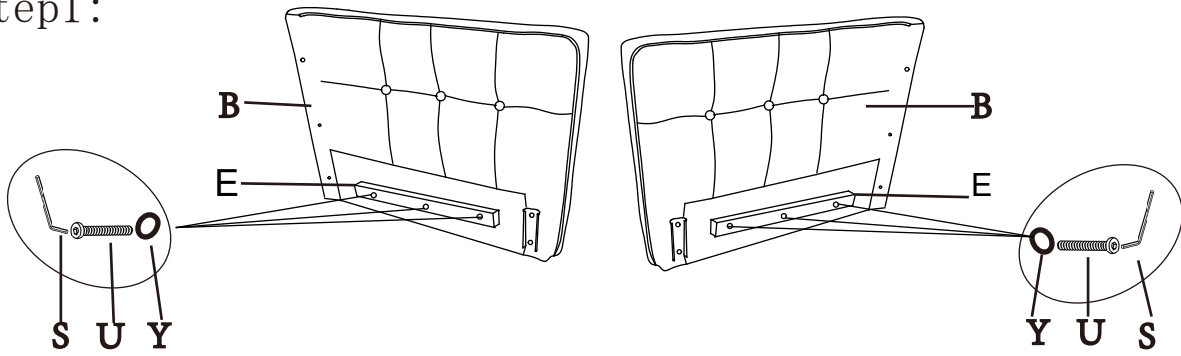

Install the wooden strips F through the holes onto the left armrest and the right armrest respectively.

Step2:

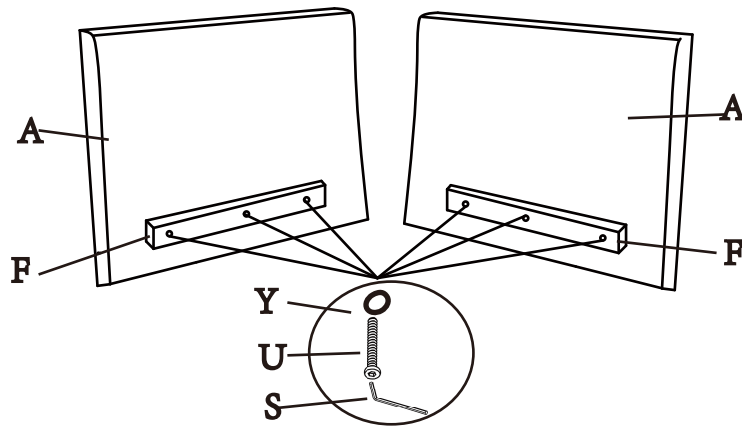

Install the wooden strip F through the holes onto the backrest.

Step3:

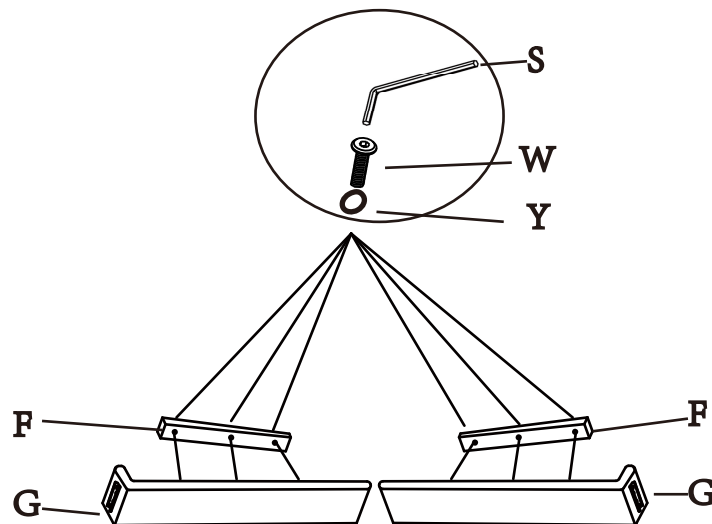

Align the holes and tighten the screws in sequence .

Step4:

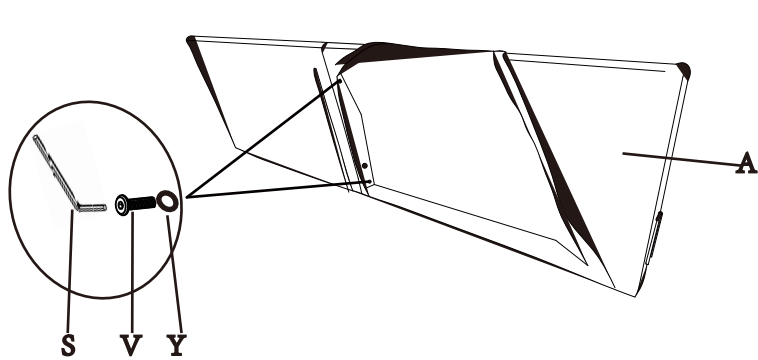

Connect the left back panel and the right back panel together using screws (you need to unzip the zipper and locate the holes)

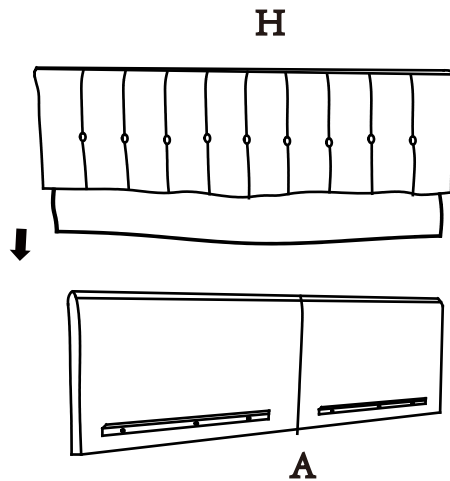

Wrap the soft cushion around the backrest board.

Step5:

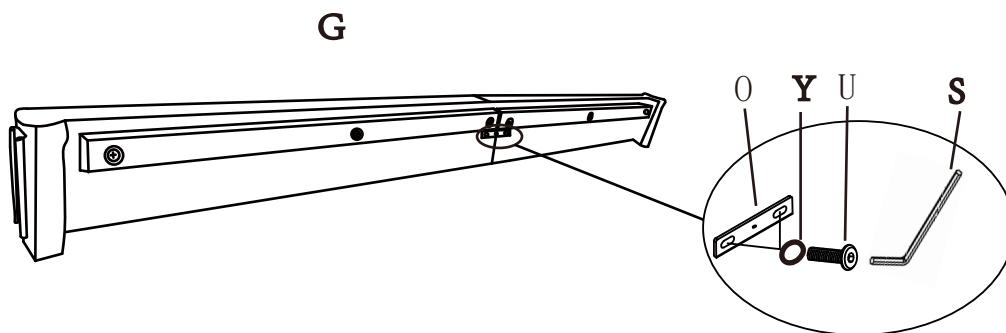

Connect and fix two boards of the front seat frame.

Step6:

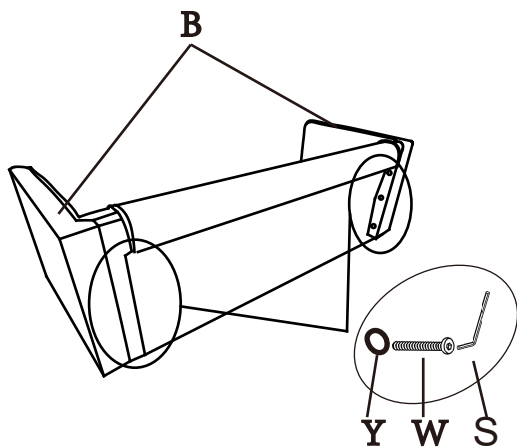

Connect the backrest and armrests with screws.

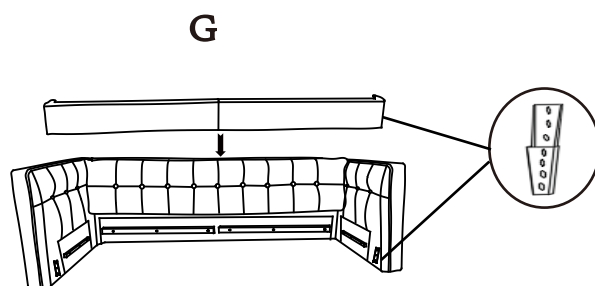

Align the front panel and insert it downward into the groove.

Step7:

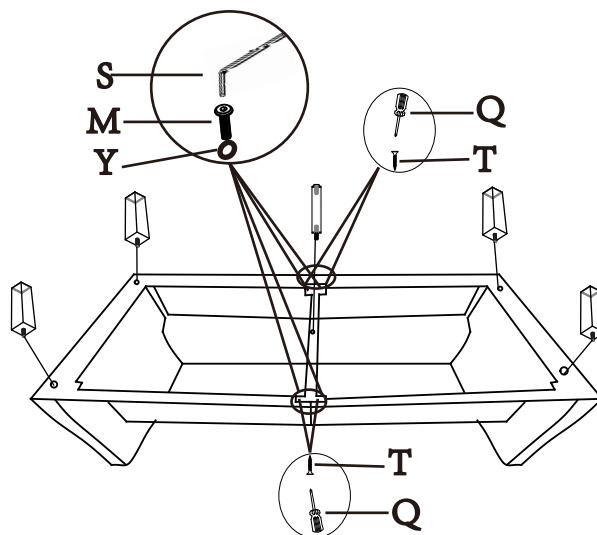

Install and fix the bottom connecting rod of the sofa with screws.
Rotate the middle leg and fix it.

Step8:

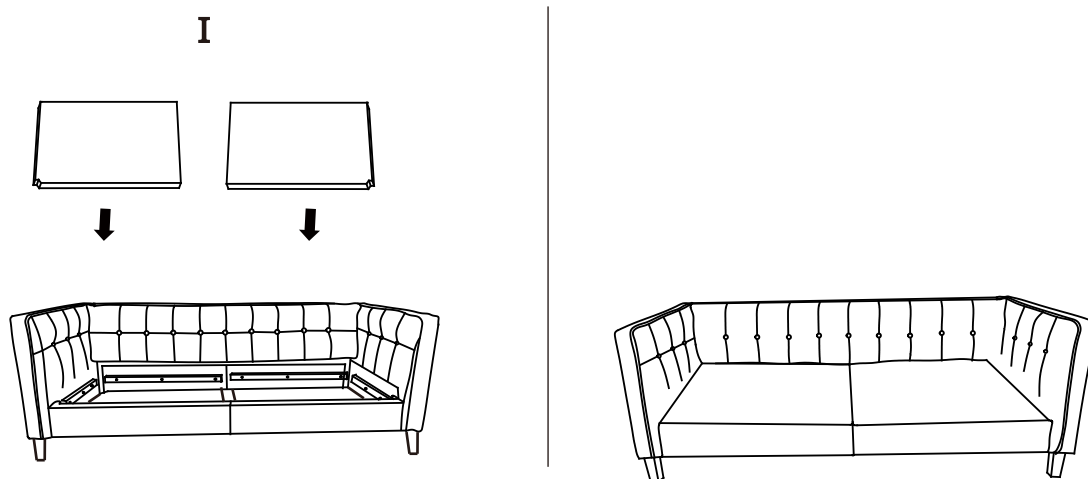

Place the two baseboards on the sofa frame.

Step9:

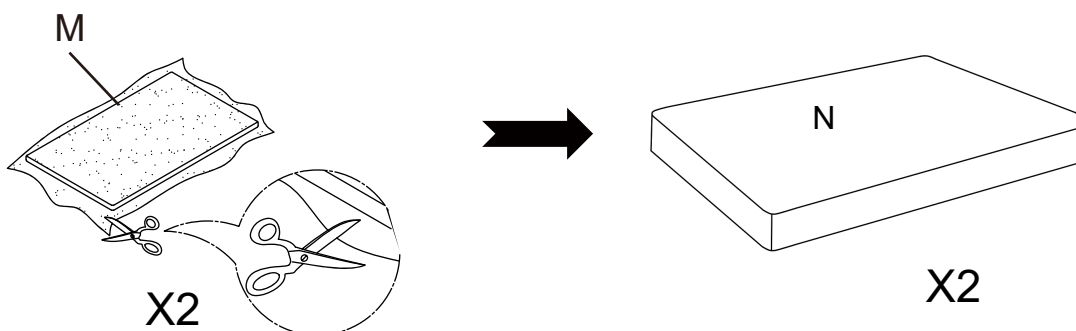

Open the zip and place the seat cushion pads evenly and flatly inside the cover.

The cushions and pillows are compressed and require a recovery period after opening, with a maximum recovery time of 48 hours.

Step7:

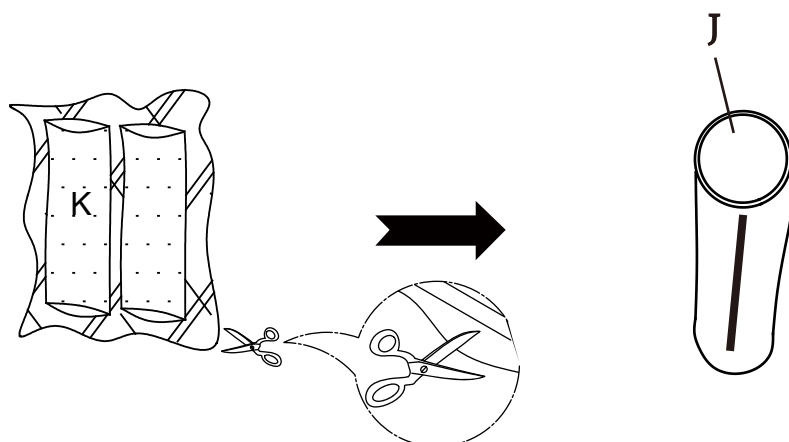

Open the zip and place the back cushion pads evenly and flatly inside the cover.

Step8:

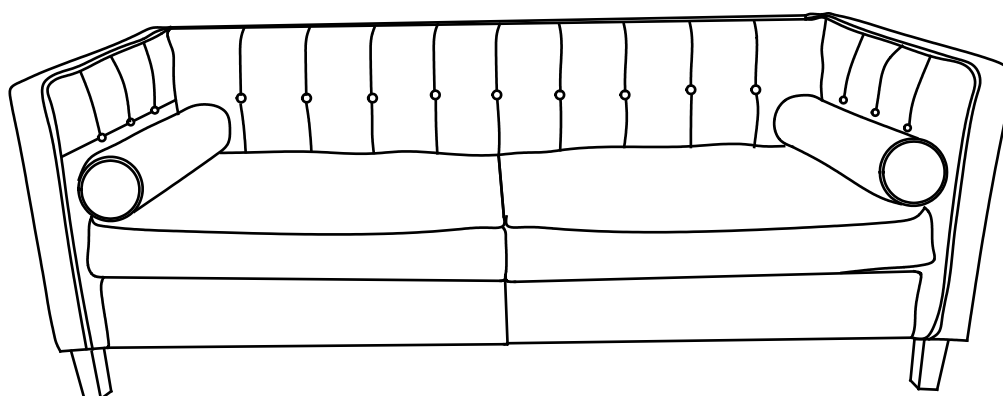

Please note that the centre legs are shorter than the other legs to ensure the load bearing and structural stability of the sofa.

FINISHED!

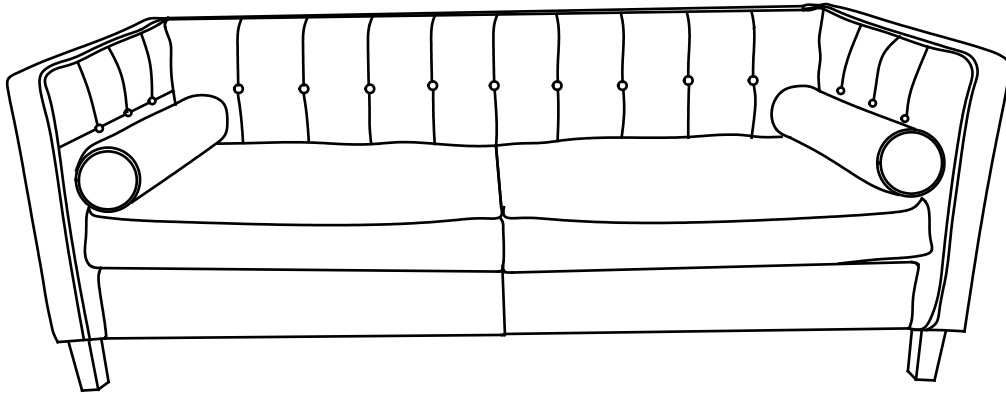

Congratulations! We're almost there! Please perform following checks to ensure assembly is properly done.

- Have you tighten all the screws?
Sit on the couch to check if the legs are shaky.
- Are the back cushions and armrests fixed properly?
Try pushing them to check if they are tightly in position.
- Adjust and pull the fabric upholstery to remove any wrinkles and ensure correct placement.

Move your product carefully, with 2 people lifting it to the preferred location. Clean the product with a damp cloth. You are all set!

Enjoy your fresh and updated living space thanks to the addition of your new product!

Frequently Asked Questions

We understand that receiving damaged or defective products can be disappointing, and we're here to assist you every step of the way. Here's how to address common concerns and initiate a damage claim:

1.What should I do if my shipment is damaged or products received are defective?

We're genuinely sorry to hear about any inconvenience caused. Please reach out to us promptly, and our team will prioritize resolving the matter swiftly and effectively, please retain the original box in case a return is required.

2.Can I return the product if I'm not satisfied?

While we uphold stringent quality standards and collaborate with experienced manufacturers, we acknowledge that dissatisfaction may arise. If you're still unsatisfied, of receiving the product. Simply message us with your reasons for return, and we'll facilitate the process.