

Top View

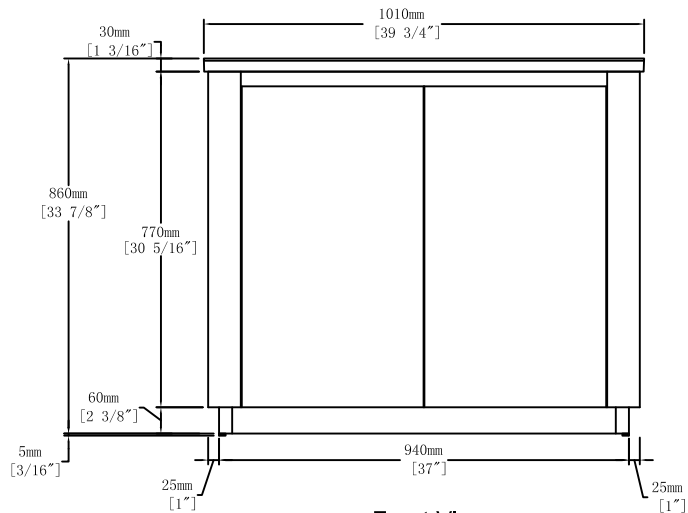

Front View

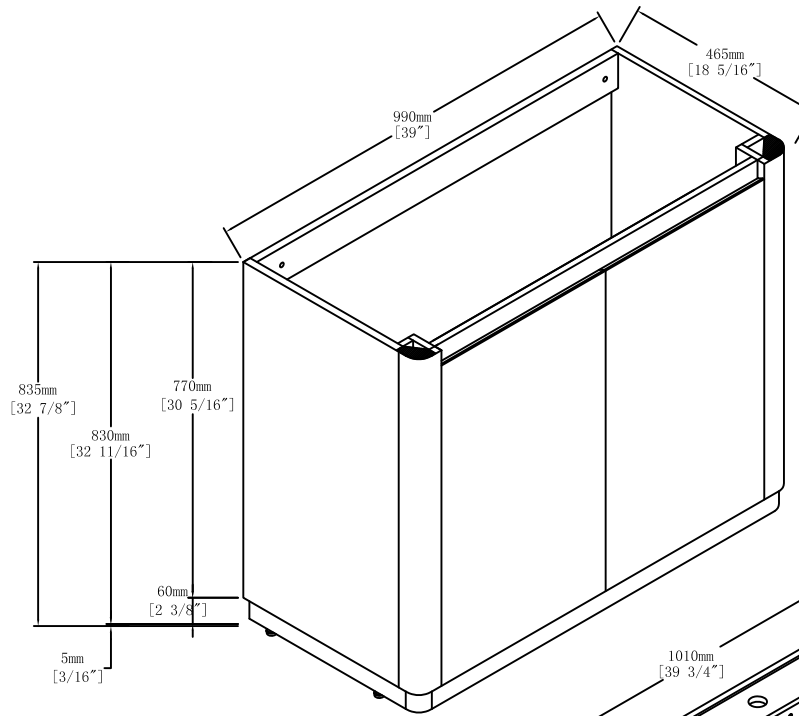
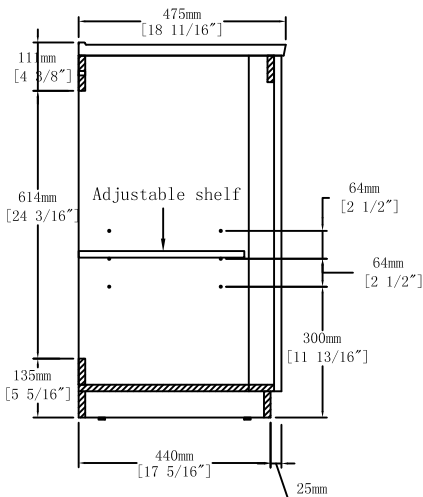

Side View

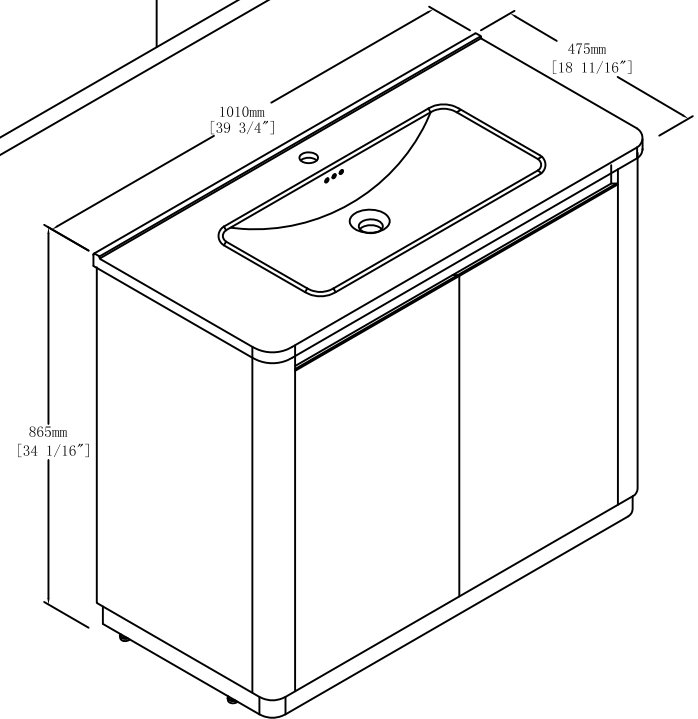

Item NO.

BV H12240

Version

V1

Project

Date

2025-4-29