

Tools Recommended

**EN\_IMPORTANT, RETAIN FOR FUTURE REFERENCE: READ CAREFULLY.**

**FR\_IMPORTANT: A LIRE ATTENTIVEMENT ET À CONSERVER POUR CONSULTATION ULTÉRIEURE.**

**ES\_IMPORTANTE, LEA Y GUARDE PARA FUTURAS REFERENCIAS.**

**PT\_IMPORTANTE, RETER PARA REFERÊNCIA FUTURA: LEIA ATENTAMENTE.**

**DE\_WICHTIG! SORGFÄLTIG LESEN UND FÜR SPÄTER NACHSCHLAGEN AUFBEWAHREN.**

**IT\_IMPORTANTE! CONSERVARE IL PRESENTE MANUALE PER FUTURO RIFERIMENTO E LEGGERLO ATTENTAMENTE.**

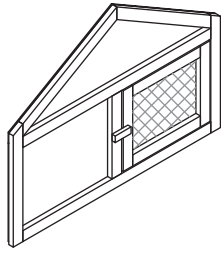

① x01

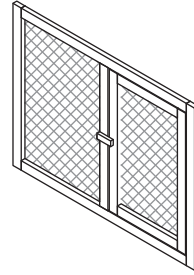

⑧ x01

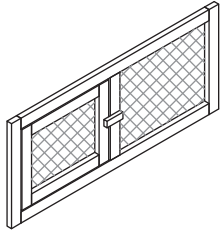

② x01

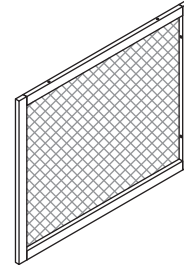

⑨ x01

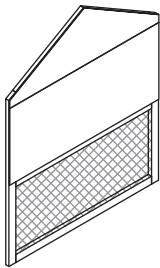

③ x01

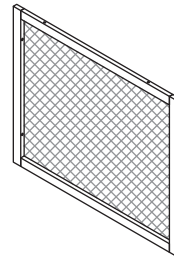

⑩ x01

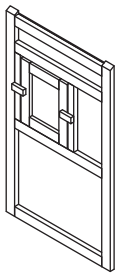

④ x01

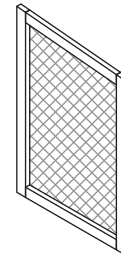

⑪ x01

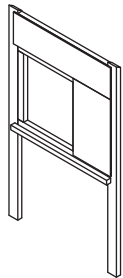

⑤ x01

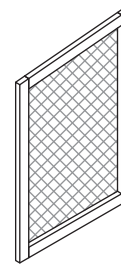

⑫ x01

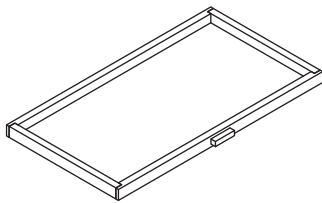

⑥ x01

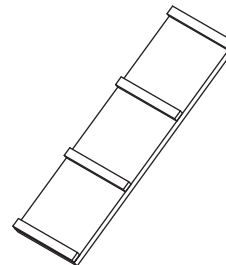

⑬ x02

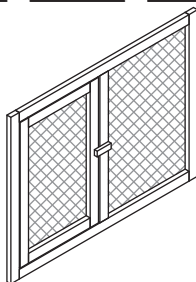

⑦ x01

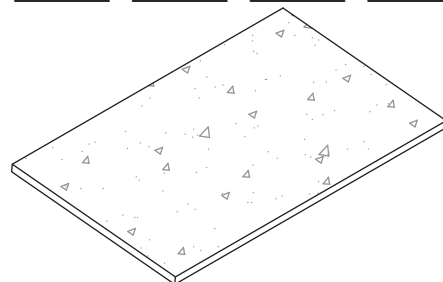

⑭ x02

④⑤ x02

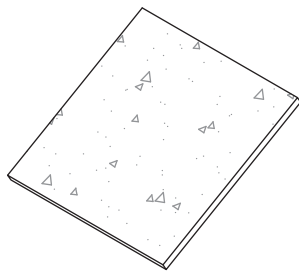

④⑥ x01

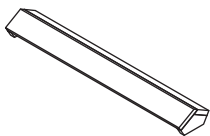

B

C

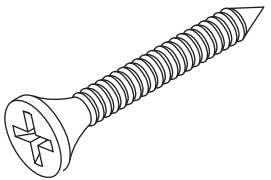
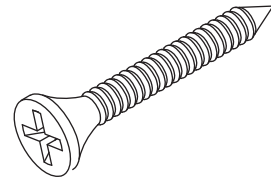
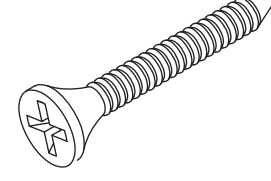
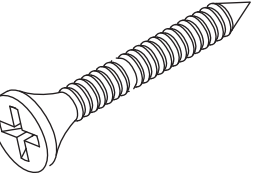
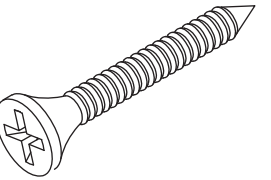
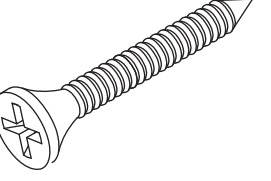
M3*16	 <p><b>A x04+1(spare)</b></p>	
M3*25	 <p><b>B x04+1(spare)</b></p>	
M3.5*30	 <p><b>C x24+2(spare)</b></p>	
M3.5*32	 <p><b>D x08+1(spare)</b></p>	
M3.5*45	 <p><b>E x08+1(spare)</b></p>	
M3.5*50	 <p><b>F x08+1(spare)</b></p>	

**EN** Do not confuse similar screws.  
**FR** Ne pas confondre des vis similaires.  
**ES** No confunda tornillos similares.  
**PT** Não confundir parafusos semelhantes.  
**DE** Verwechseln Sie ähnliche Schrauben nicht.  
**IT** Non confondere le viti simili.

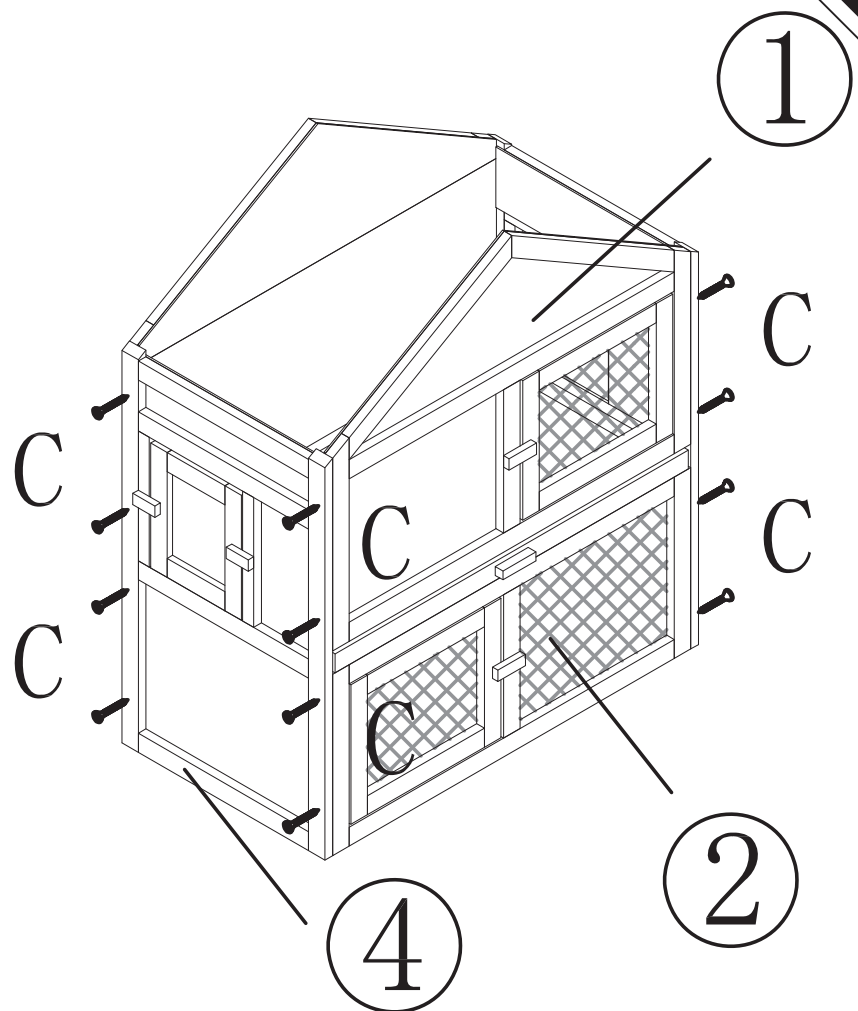
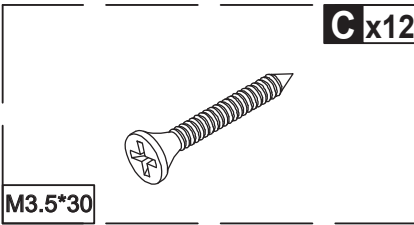
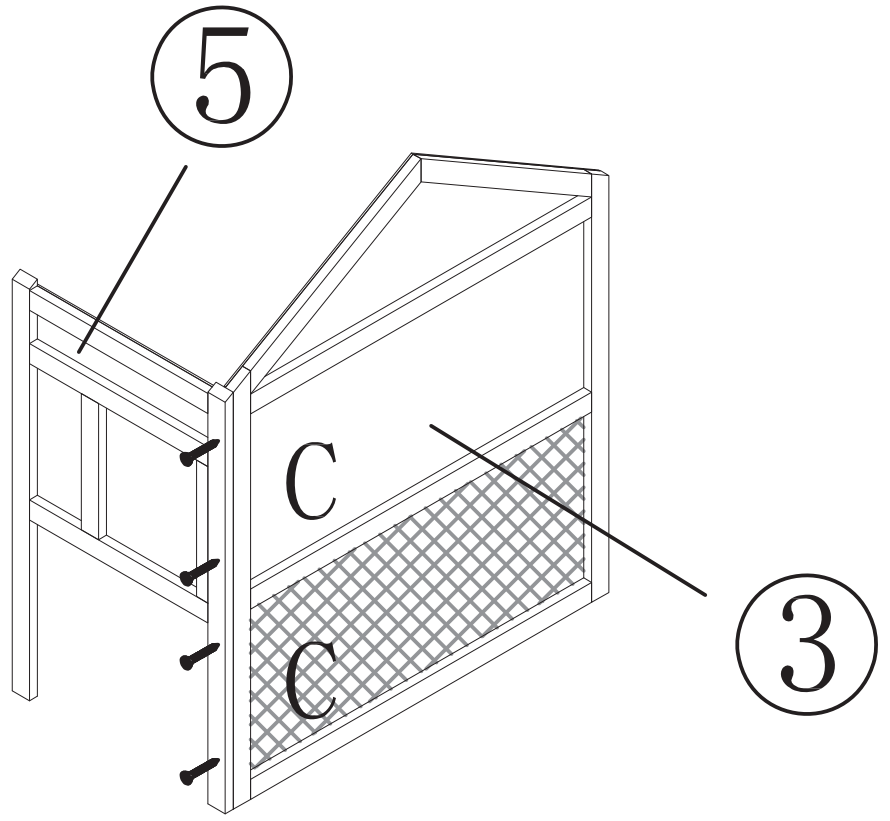
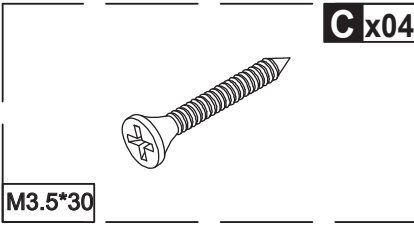

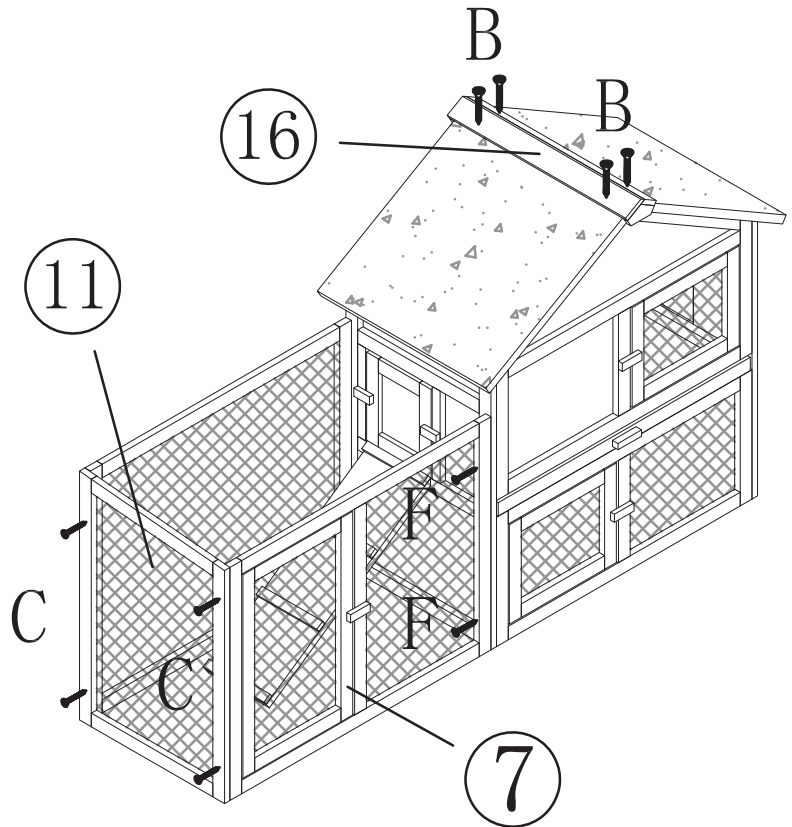
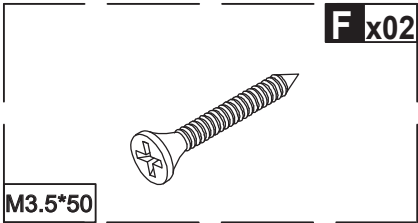
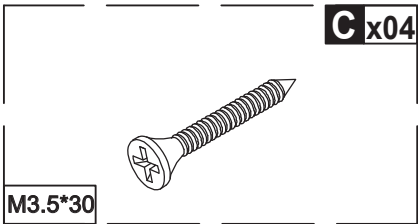
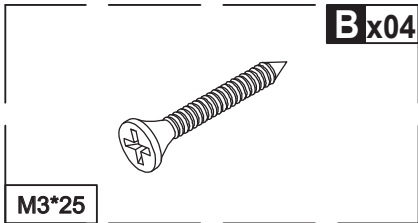
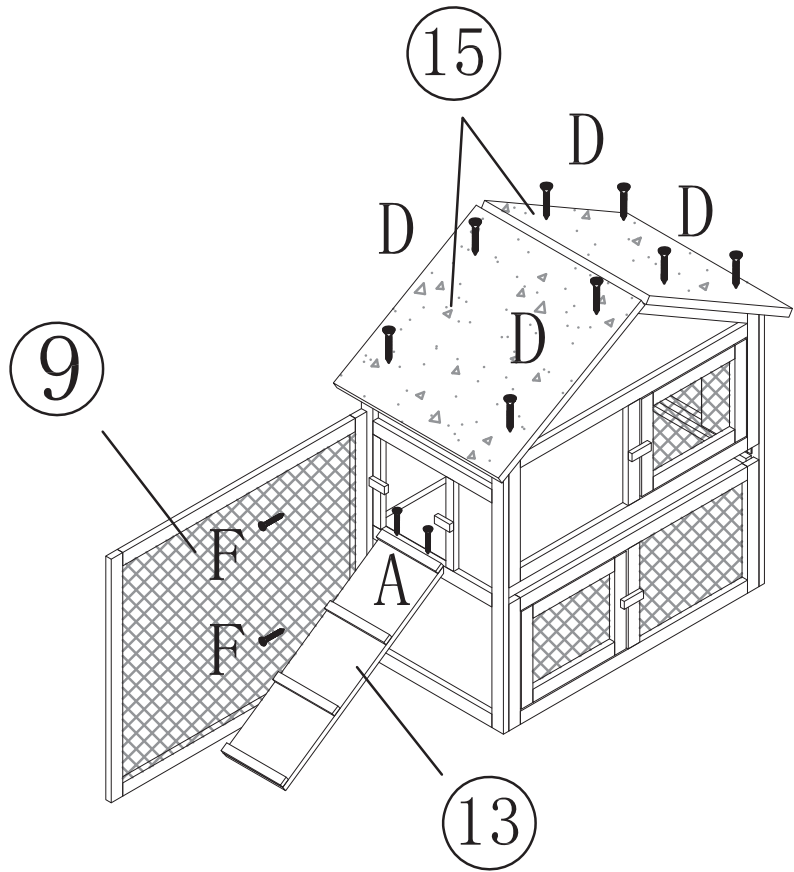
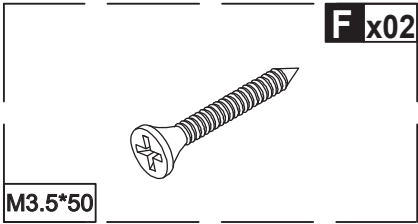
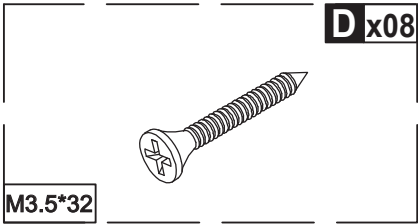
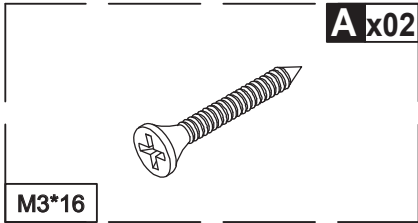

**A** x02

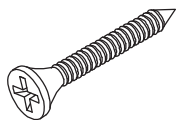

M3\*16

**F** x02

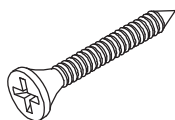

M3.5\*50

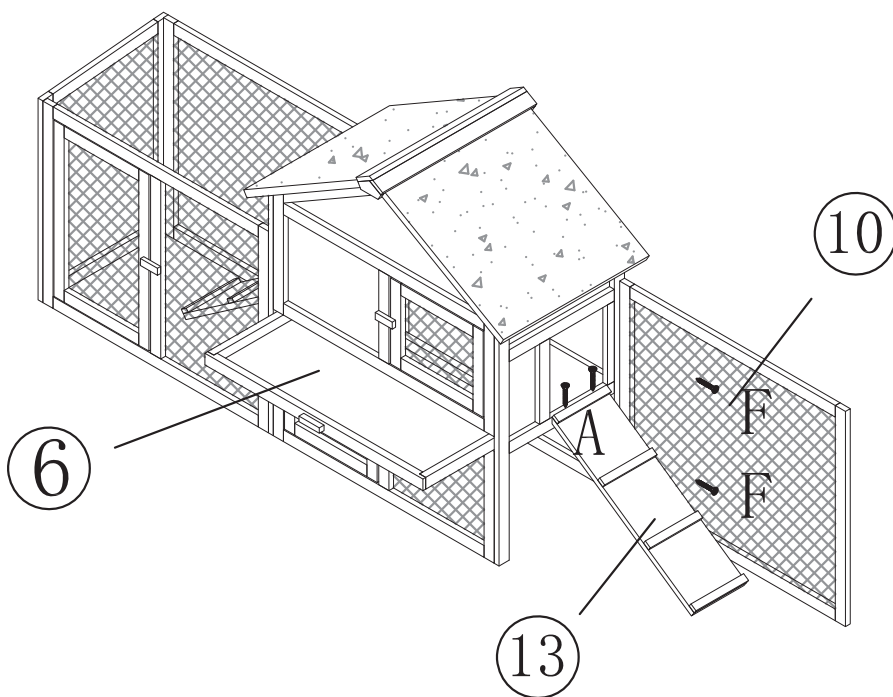

**C** x04

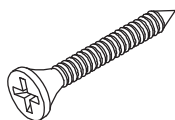

M3.5\*30

**F** x02

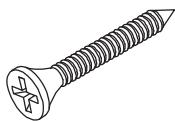

M3.5\*50

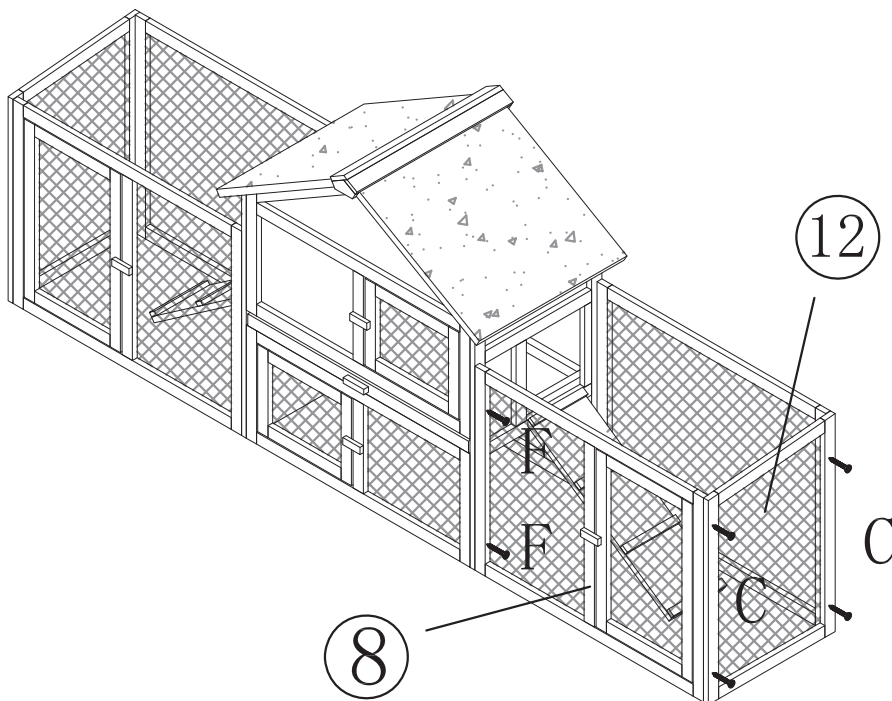

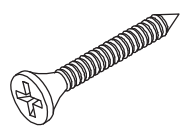

**E**x04

M3.5\*45

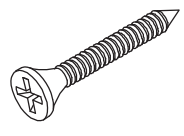
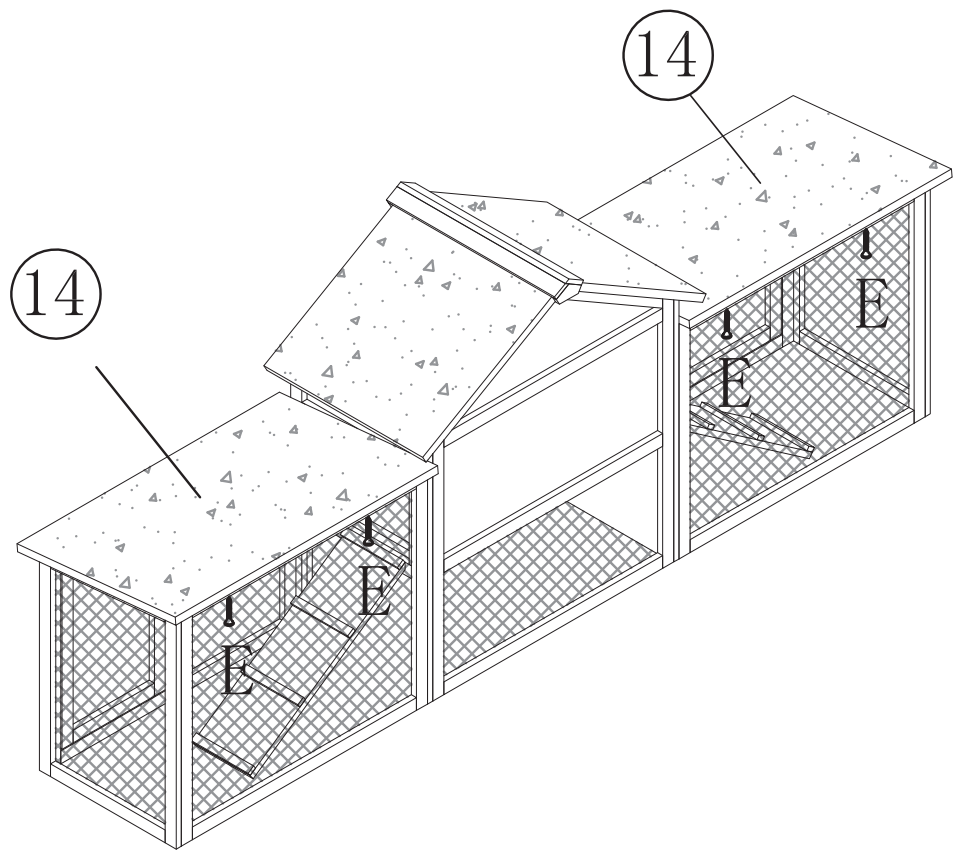

**E**x04

M3.5\*45

