

Assembly Instruction

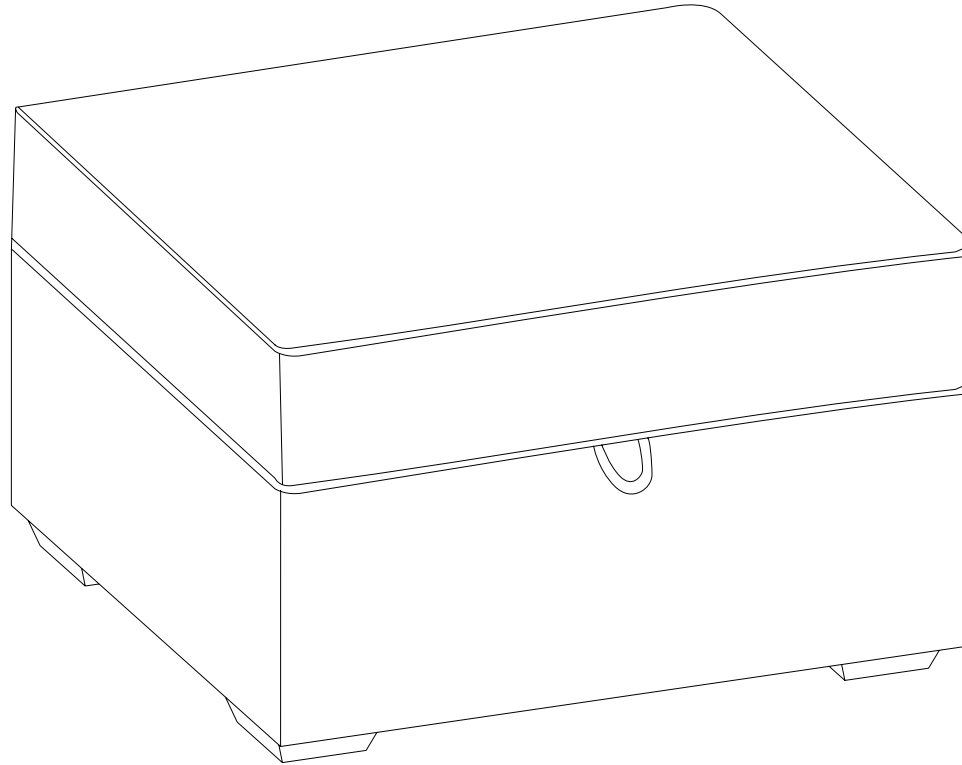

Dear Customers,

Thank you for purchasing our product. Please read this instruction manual carefully after receiving this product. It will help you assemble this product quickly, safely and correctly. You can keep this manual for future reference.



Safety and Care Advice

Important – Please read these instructions fully before starting assembly

Thanks for your purchase. Before assembling, please follow the instructions to check if all the spare parts and screws are intact.

- Considering the size and weight of the sofa, we recommend two adults to assemble the sofa, on a carpeted or padded area, in the room that it is intended for. Approximate assembly time: 30 minutes.
- Keep all components and packaging out of reach of children or animals to avoid the risk of choking or suffocation.
- Please do not throw away any of the packaging or the instruction until you have checked all the components and hardware and the furniture is fully assembled. Please ensure that the packaging is disposed in a safe and environmentally friendly way.
- Please do not take off the cover, and do not wash.

Your cushions come vacuum packed and sealed for shipping. To restore the cushion's original shape, follow the steps below.

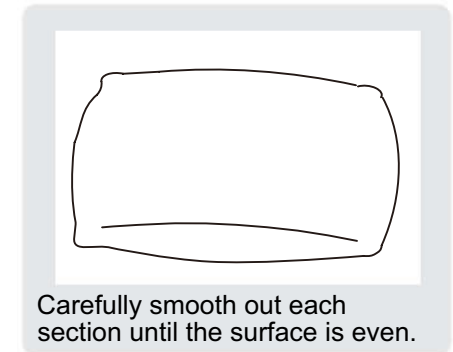
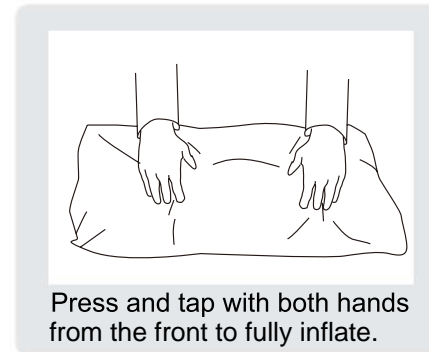
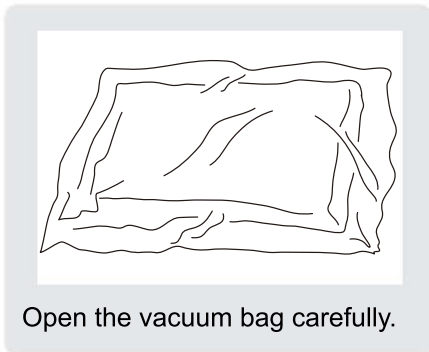

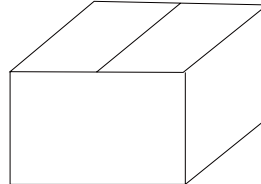

After packing up, place them in somewhere dry and ventilated. After about 72-96 hours. It can be restored to the best use condition.

BOX1







Main structure accessories

A		Ottoman Frame	x1
B		Ottoman Top Bezel	x1
C		Cushion	x1

Structure accessories

a		Sofa Leg	x4
----------	---	----------	----

Hardware parts(Corner)

b		M6	Allen Key	x1
c		M8*70	Bolt	x4
d		M8*18*1.5	Wahser	x4
e		M8	Wahser	x4

Ottoman

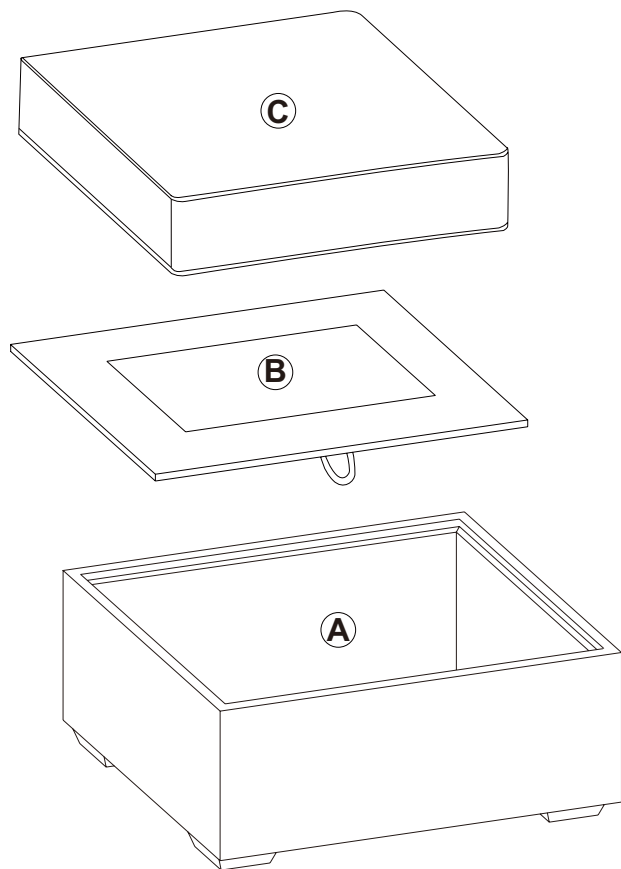

Hardware parts

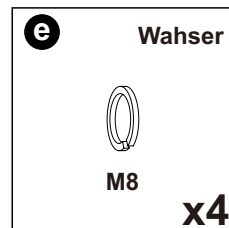
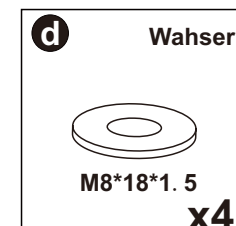
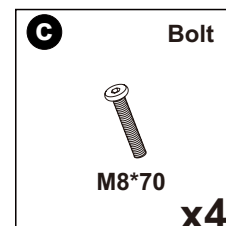
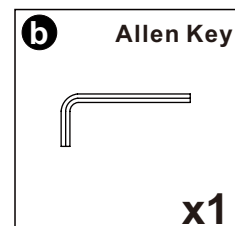
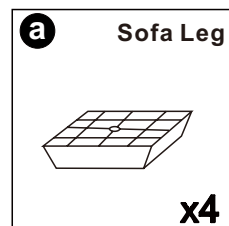

Main structure accessories

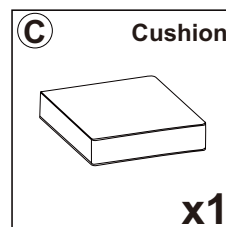
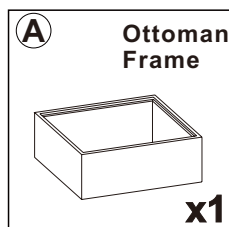

STEP 1

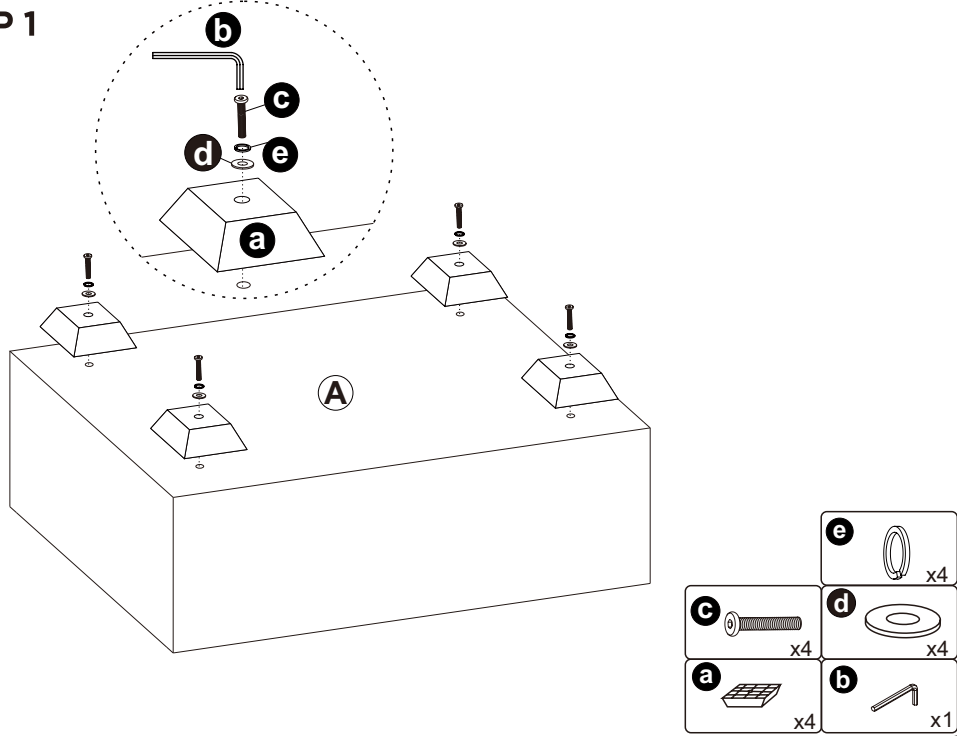

STEP 2

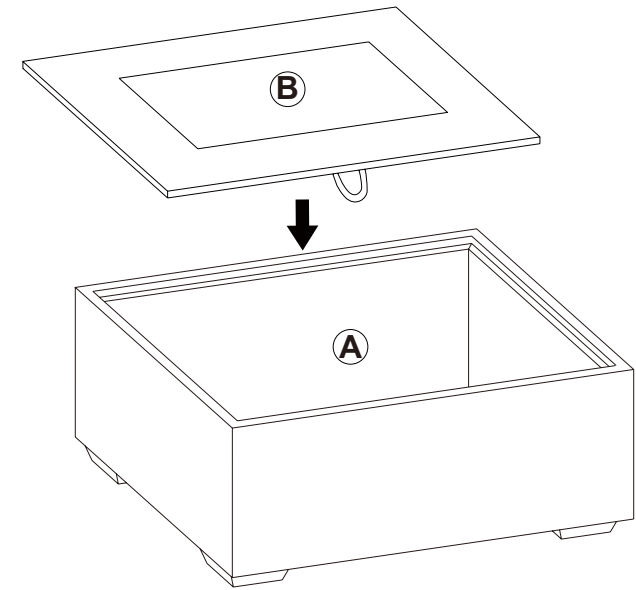

STEP 3

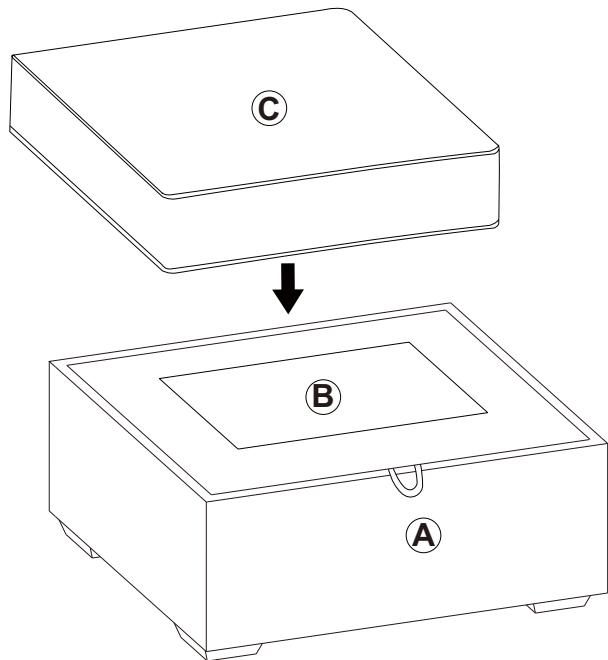

STEP 4

