

Cat rack

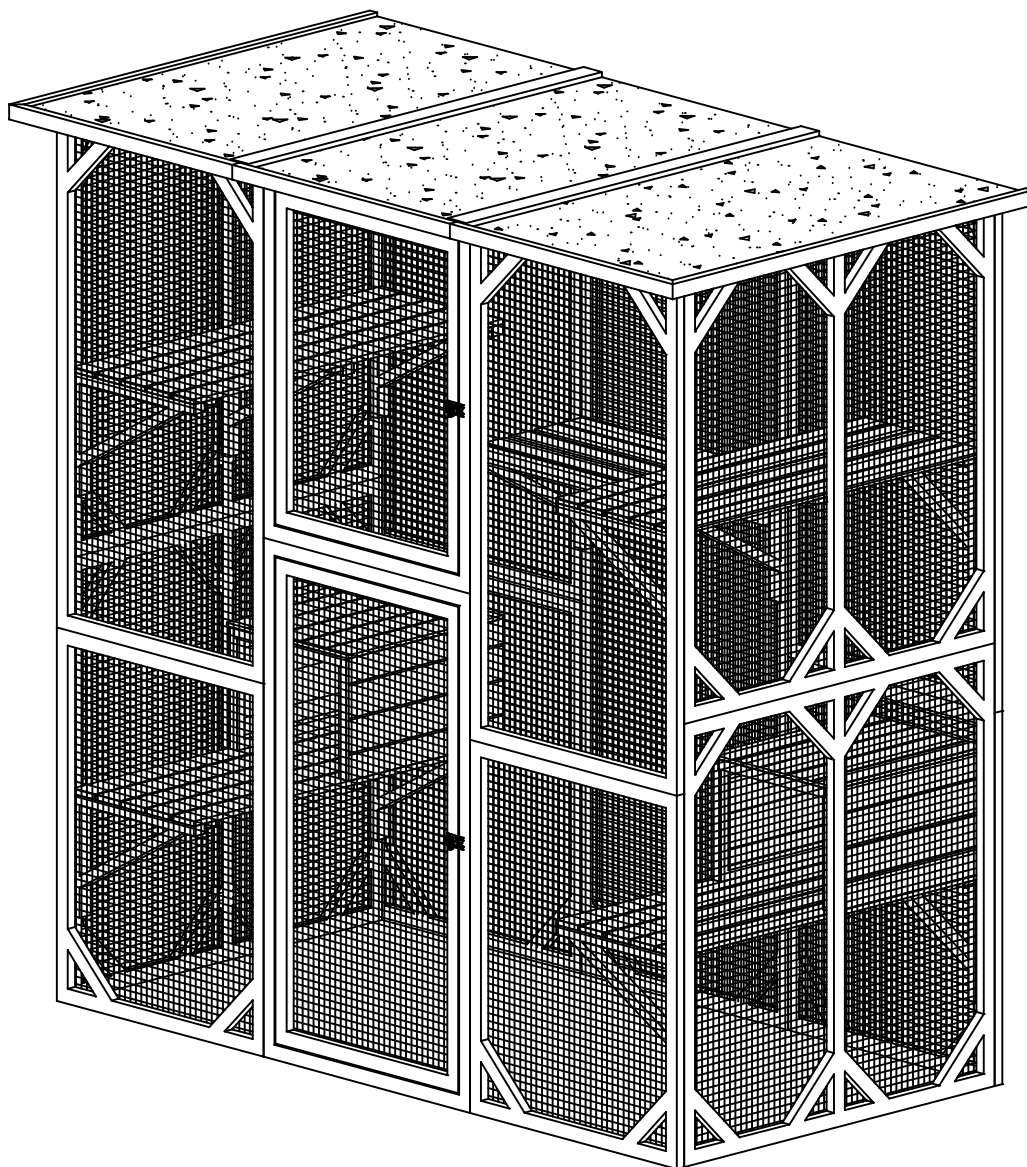

GA3007



vipservice202401@163.com

Parts List (Box B)

①

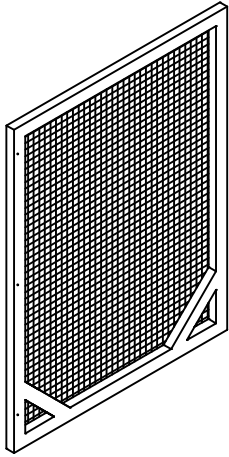

2PCS

②

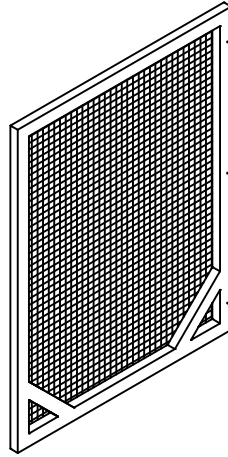

2PCS

③

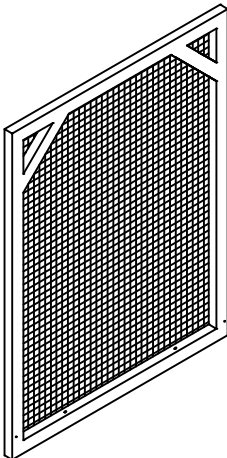

1PC

⑪

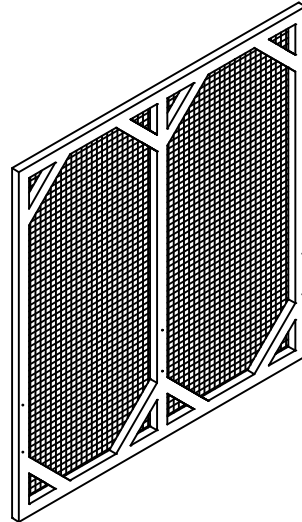

2PCS

⑫

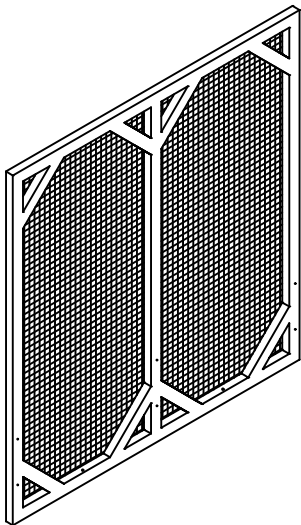

2PCS

⑧

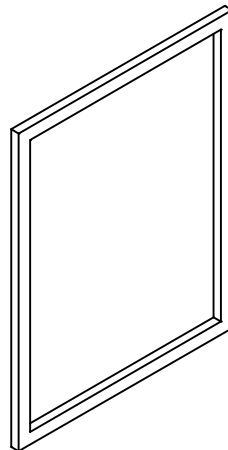

1PC

10

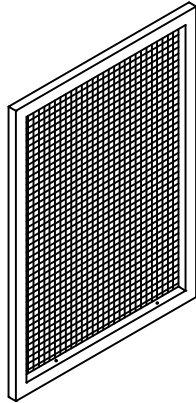

1PC

15

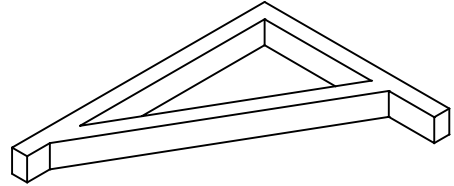

10PCS

17

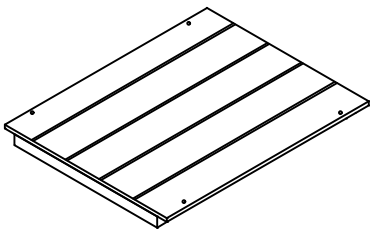

2PCS

18

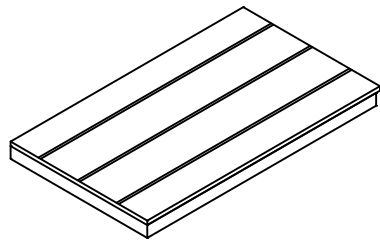

4PCS

16

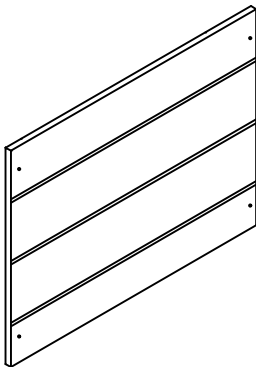

2PCS

Parts List (Box A)

⑦

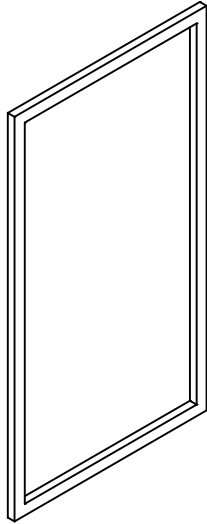

1PC

⑨

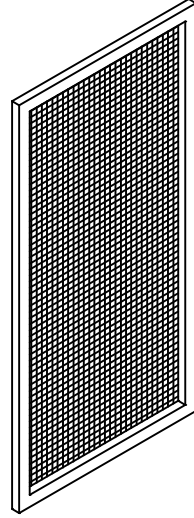

1PC

④

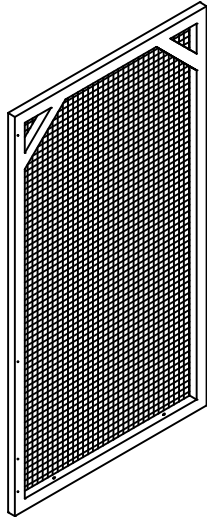

2PCS

⑤

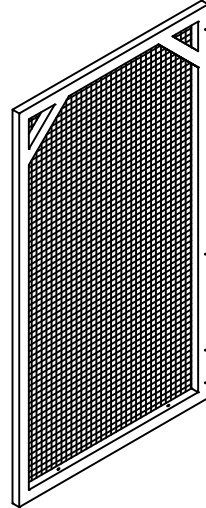

2PCS

⑥

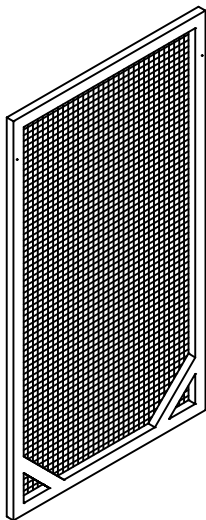

1PC

⑬

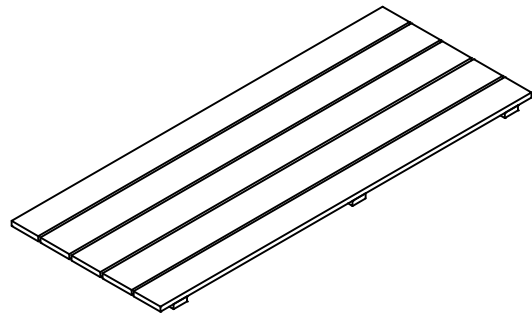

4PCS

Parts List (Box A)

14

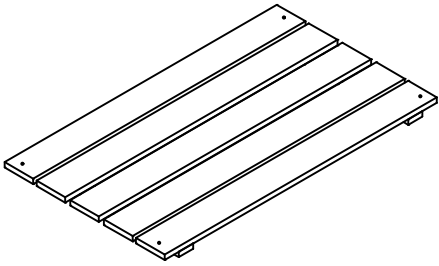

1PC

19

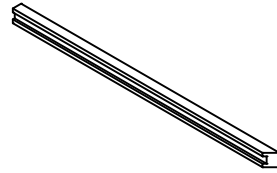

1PC

20

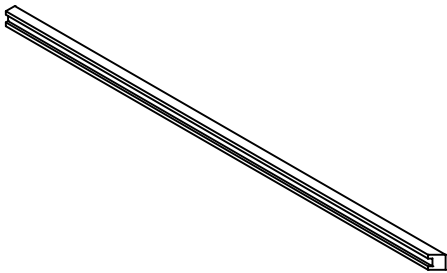

1PC

21

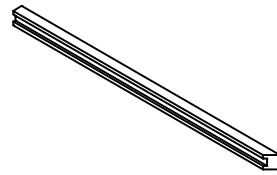

1PC

22

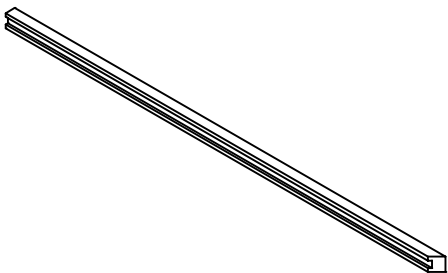

1PC

23

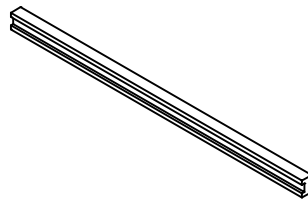

1PC

24

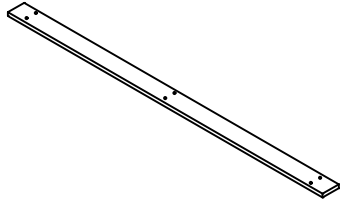

2PCS

25

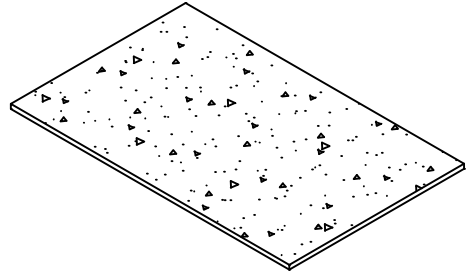

1PC

26

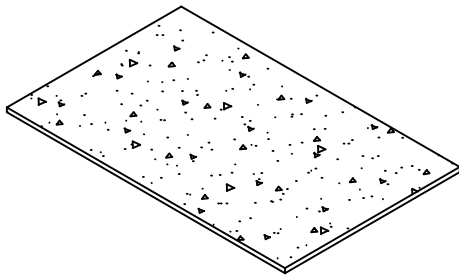

1PC

27

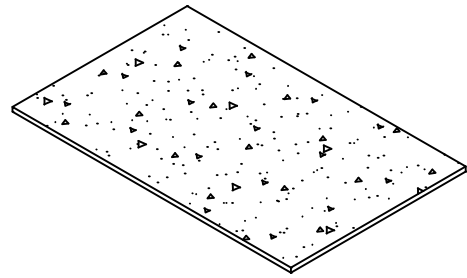

1PC

28

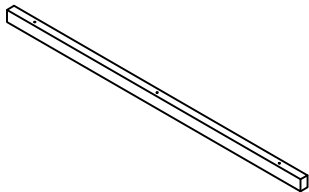

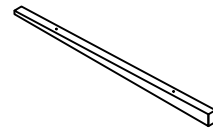

2PC

29

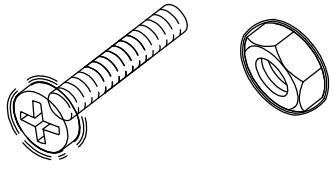
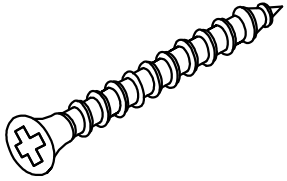
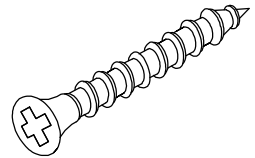
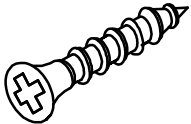
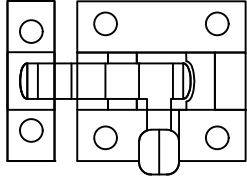

2PC

COMPONENTS

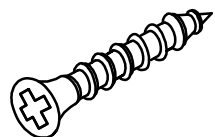
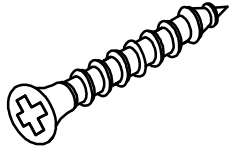
<p style="font-size: 24px; font-weight: bold; margin-bottom: 20px;">A</p> <div style="text-align: center;">  </div> <div style="display: flex; justify-content: space-between; margin-top: 20px;"> M6x40mm <div style="border: 1px solid black; padding: 2px 5px;">+1 (spare)</div> <div style="border: 1px solid black; padding: 2px 5px; font-weight: bold;">20PCS</div> </div>	<p style="font-size: 24px; font-weight: bold; margin-bottom: 20px;">B</p> <div style="text-align: center;">  </div> <div style="display: flex; justify-content: space-between; margin-top: 20px;"> M3.5x45mm <div style="border: 1px solid black; padding: 2px 5px;">+1 (spare)</div> <div style="border: 1px solid black; padding: 2px 5px; font-weight: bold;">38PCS</div> </div>
<p style="font-size: 24px; font-weight: bold; margin-bottom: 20px;">C</p> <div style="text-align: center;">  </div> <div style="display: flex; justify-content: space-between; margin-top: 20px;"> M3.5x35mm <div style="border: 1px solid black; padding: 2px 5px;">+1 (spare)</div> <div style="border: 1px solid black; padding: 2px 5px; font-weight: bold;">38PCS</div> </div>	<p style="font-size: 24px; font-weight: bold; margin-bottom: 20px;">D</p> <div style="text-align: center;">  </div> <div style="display: flex; justify-content: space-between; margin-top: 20px;"> M3.5x20mm <div style="border: 1px solid black; padding: 2px 5px;">+2 (spare)</div> <div style="border: 1px solid black; padding: 2px 5px; font-weight: bold;">44PCS</div> </div>
<p style="font-size: 24px; font-weight: bold; margin-bottom: 20px;">E</p> <div style="text-align: center;">  </div> <div style="display: flex; justify-content: space-between; margin-top: 20px;"> <div style="border: 1px solid black; padding: 2px 5px;">+1 (spare)</div> <div style="border: 1px solid black; padding: 2px 5px; font-weight: bold;">2PCS</div> </div>	<p style="font-size: 24px; font-weight: bold; margin-bottom: 20px;">F</p> <div style="text-align: center;">  </div> <div style="display: flex; justify-content: space-between; margin-top: 20px;"> M3.0x10mm <div style="border: 1px solid black; padding: 2px 5px;">+1 (spare)</div> <div style="border: 1px solid black; padding: 2px 5px; font-weight: bold;">20PCS</div> </div>
<p style="font-size: 24px; font-weight: bold; margin-bottom: 20px;">G</p> <div style="text-align: center;">  </div> <div style="display: flex; justify-content: space-between; margin-top: 20px;"> M3.5x25mm <div style="border: 1px solid black; padding: 2px 5px;">+1 (spare)</div> <div style="border: 1px solid black; padding: 2px 5px; font-weight: bold;">14PCS</div> </div>	<p style="font-size: 24px; font-weight: bold; margin-bottom: 20px;">H</p> <div style="text-align: center;">  </div> <div style="display: flex; justify-content: space-between; margin-top: 20px;"> M3x30mm <div style="border: 1px solid black; padding: 2px 5px;">+1 (spare)</div> <div style="border: 1px solid black; padding: 2px 5px; font-weight: bold;">17PCS</div> </div>

Assembly Steps

1

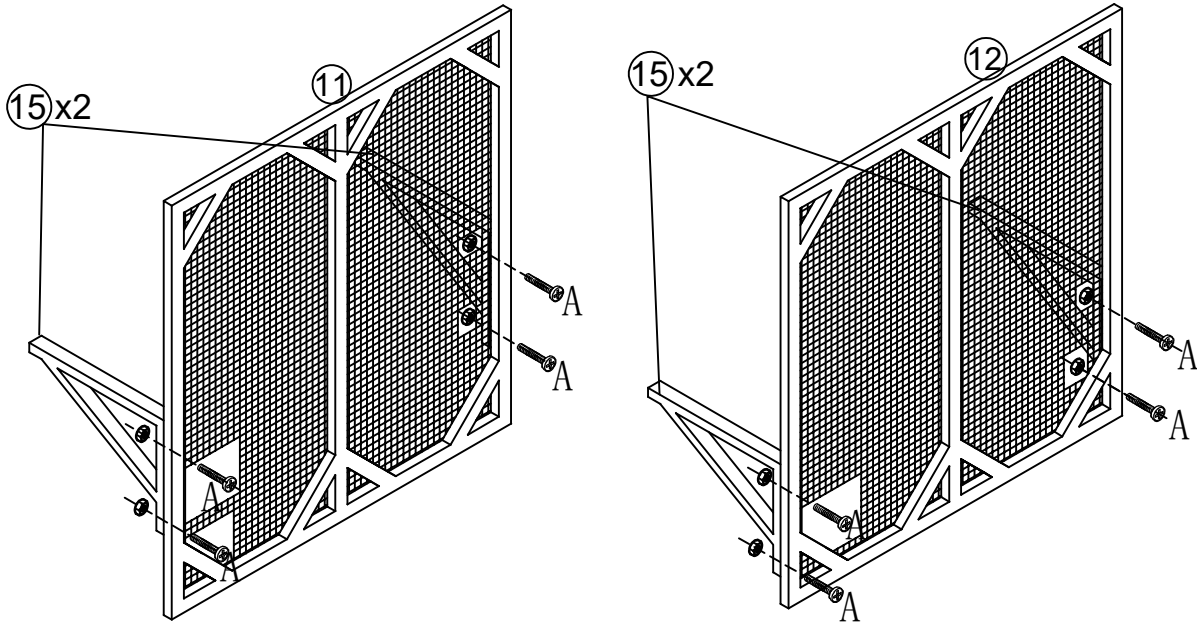
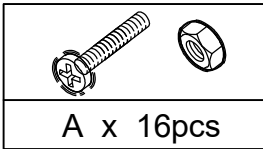

This step needs to be repeated twice.

2

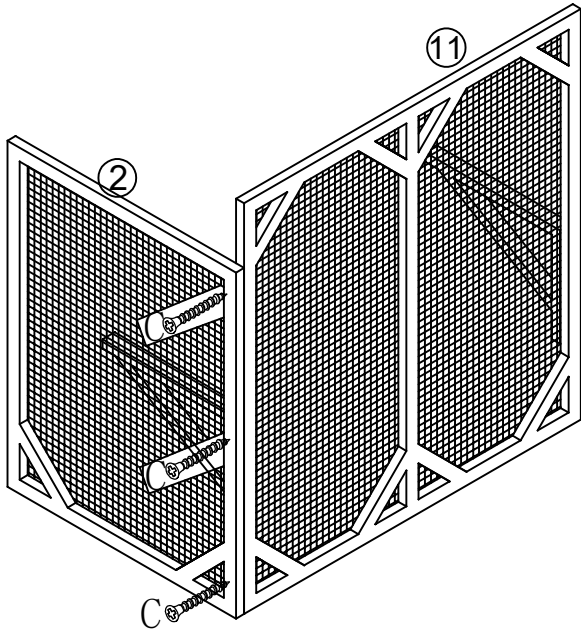
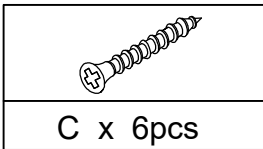

This step needs to be repeated twice.

3

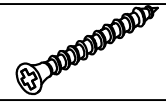
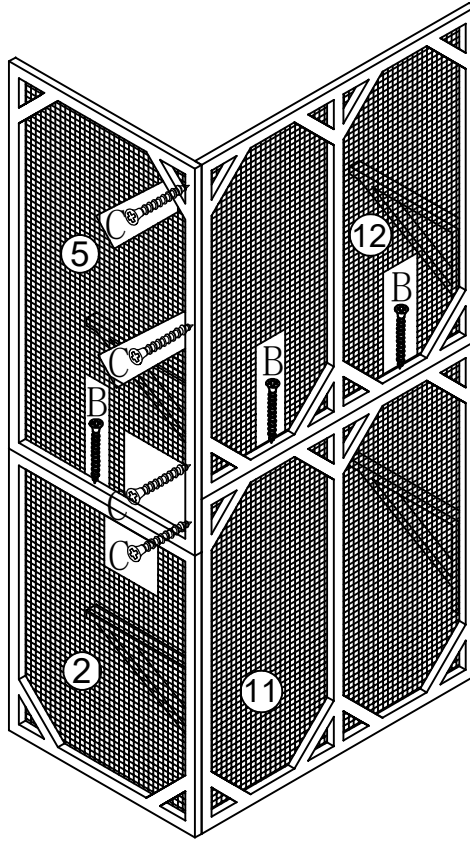

B x 6pcs

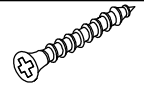

C x 8pcs

This step needs to be repeated twice.

4

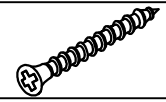
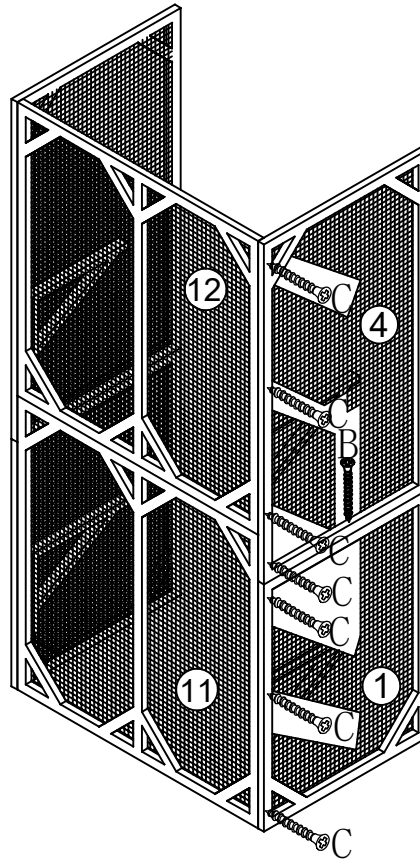

B x 2pcs

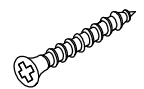

C x 14pcs

This step needs to be repeated twice.

5

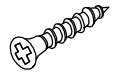
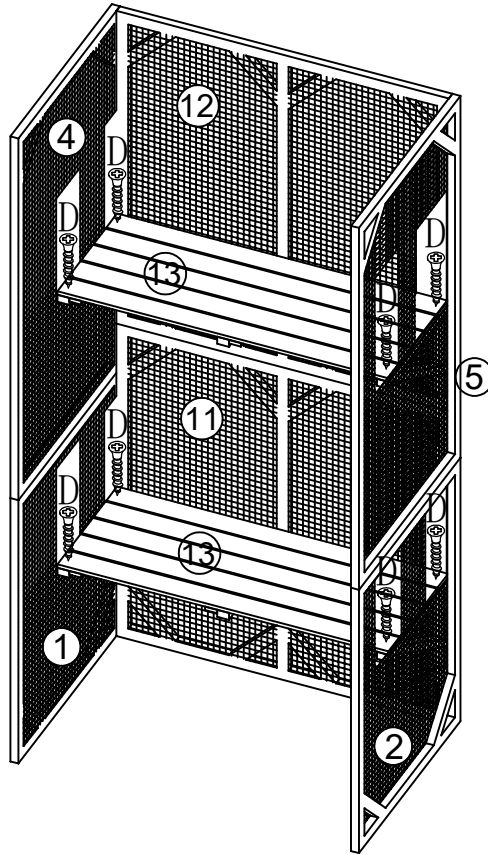

D x 16pcs

This step needs to be repeated twice.

6

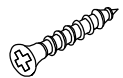
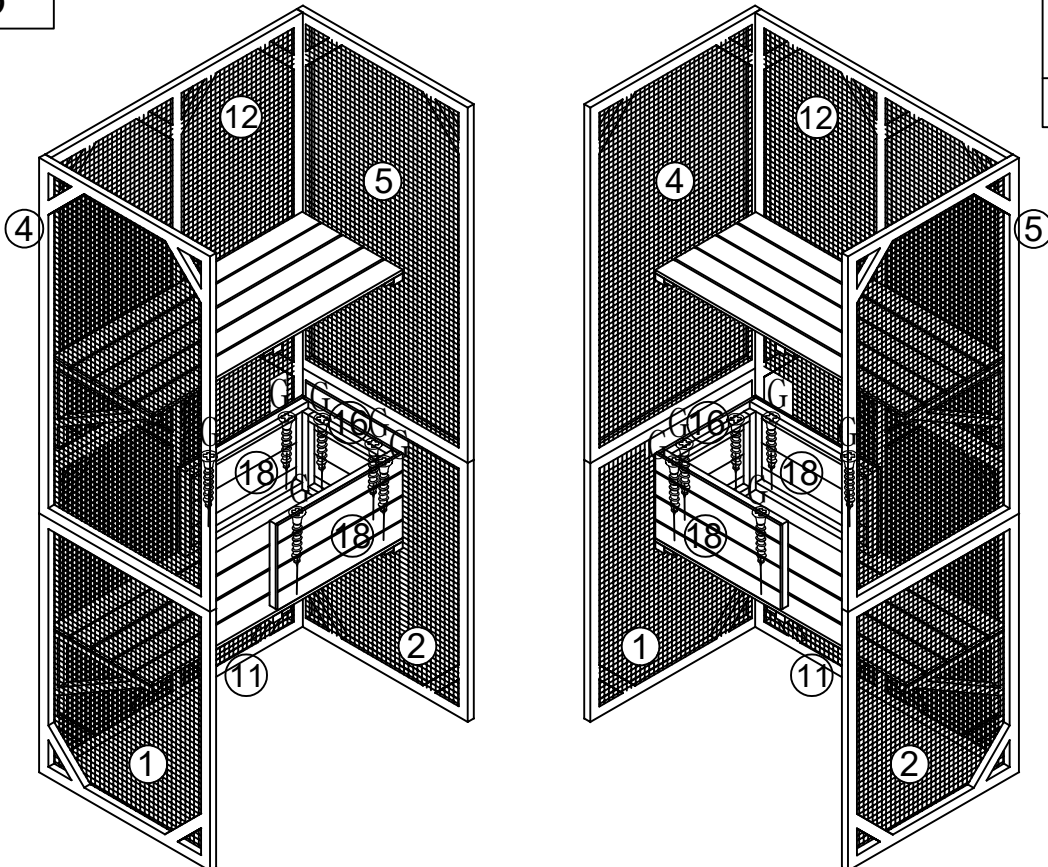

G x 12pcs

7

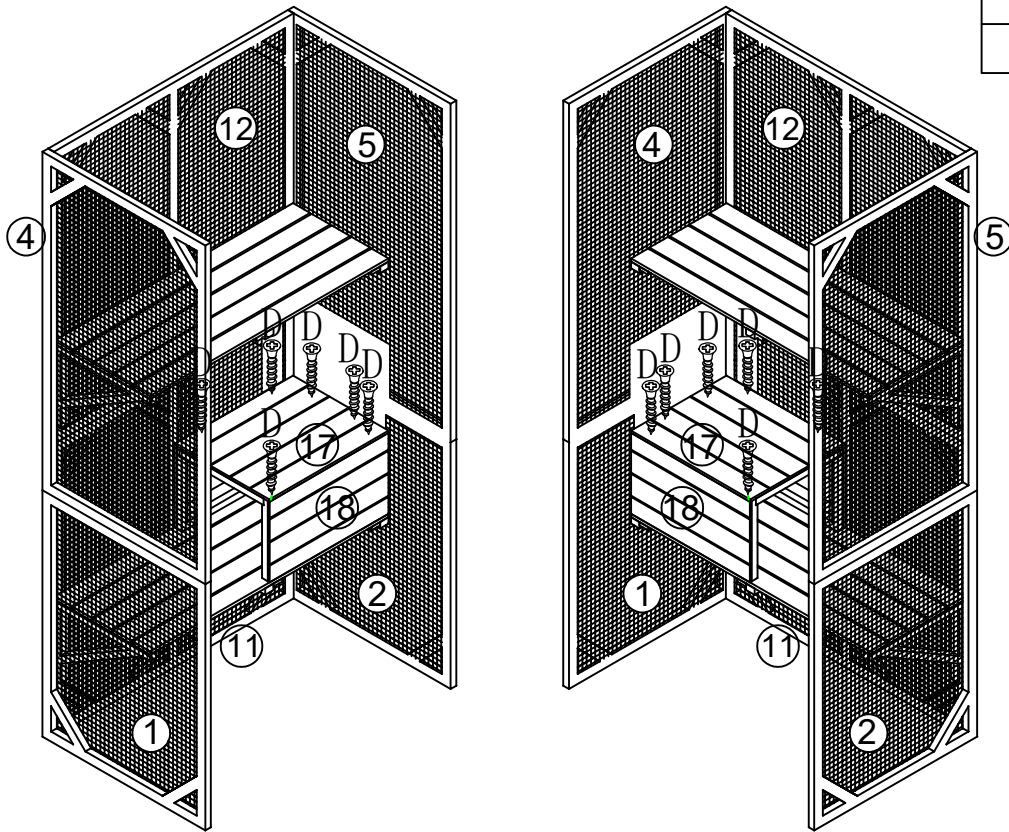

D x 12pcs

8

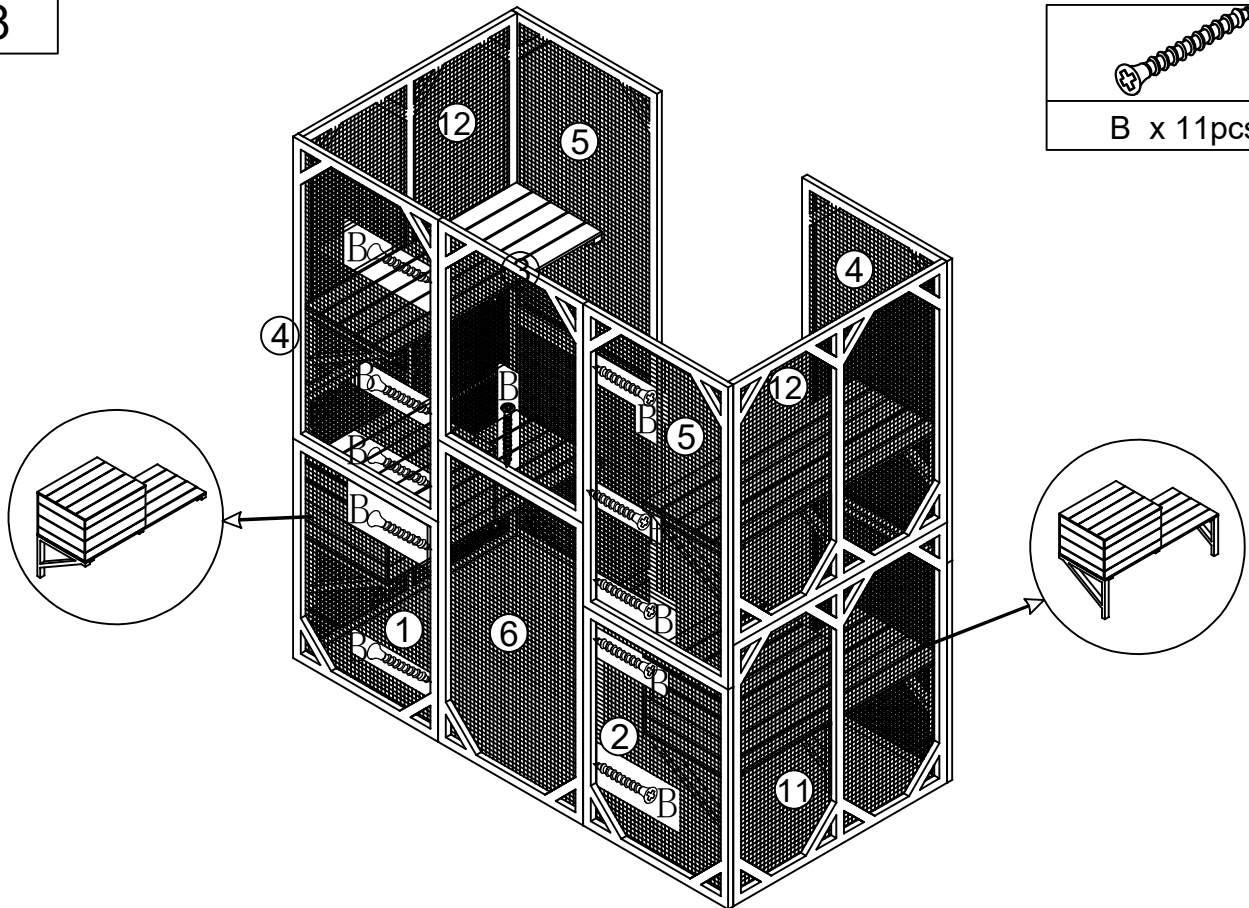

B x 11pcs

9

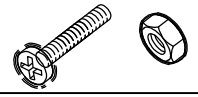
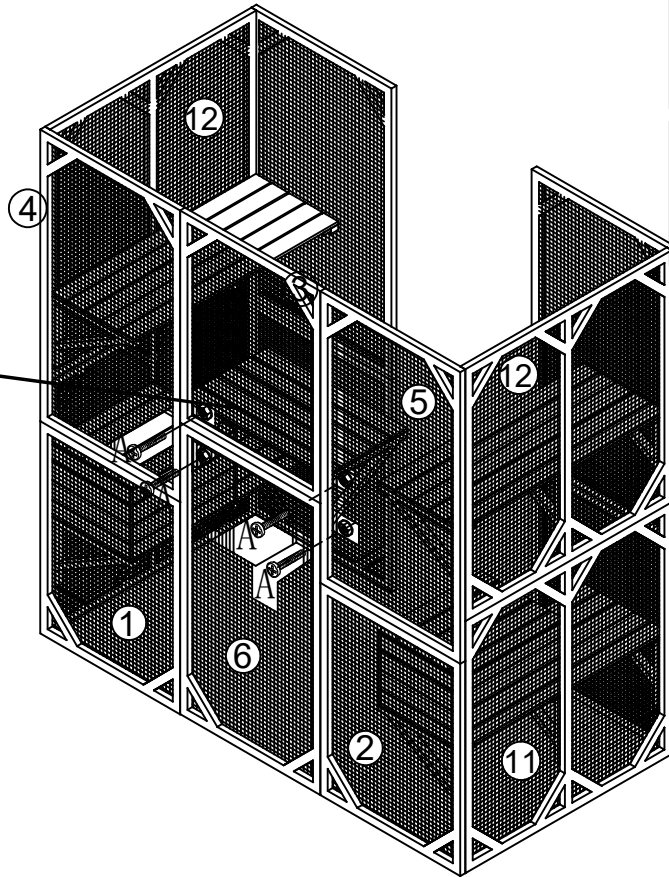
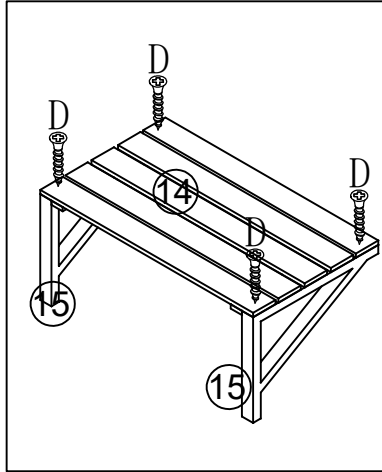

A x 4pcs

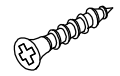

D x 4pcs

10

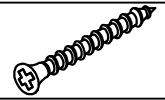
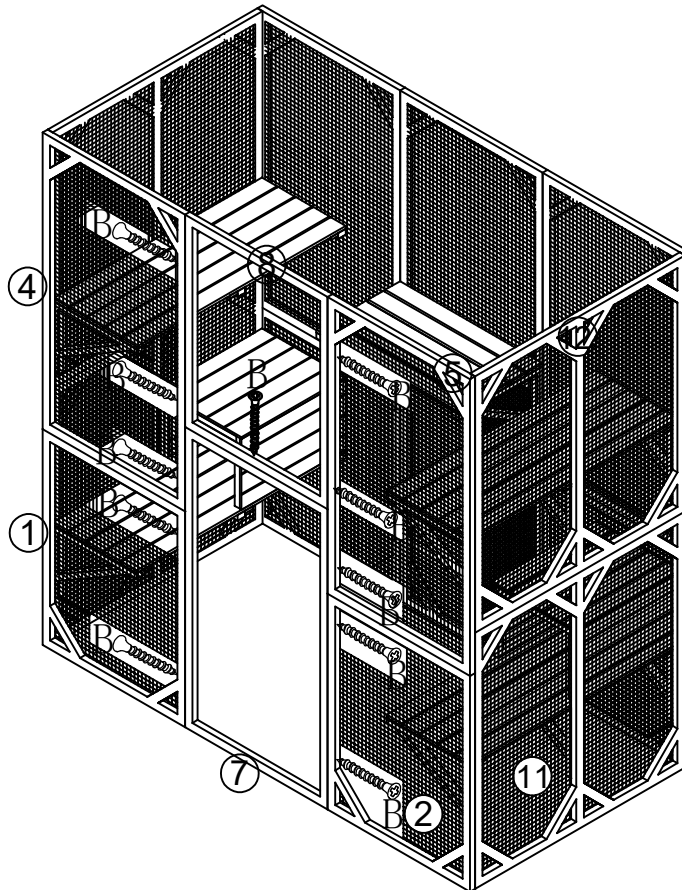

B x 11pcs

11



F x 8 pcs

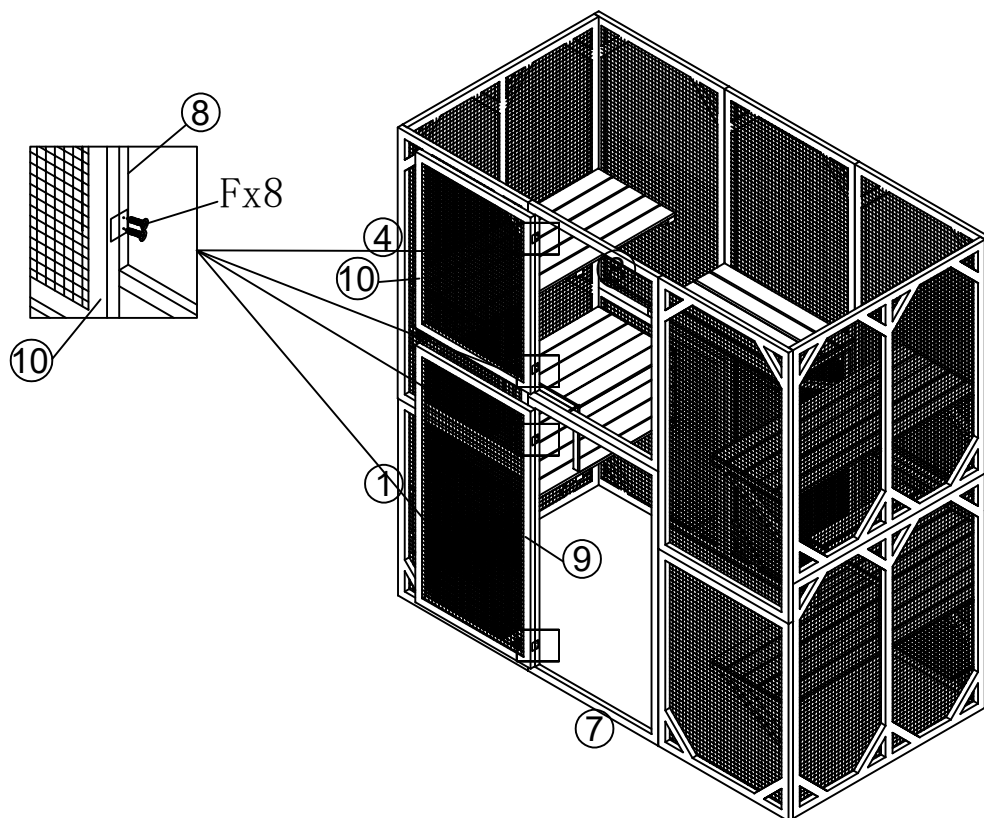

12

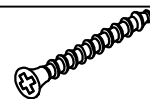

B x 8 pcs



G x 2 pcs

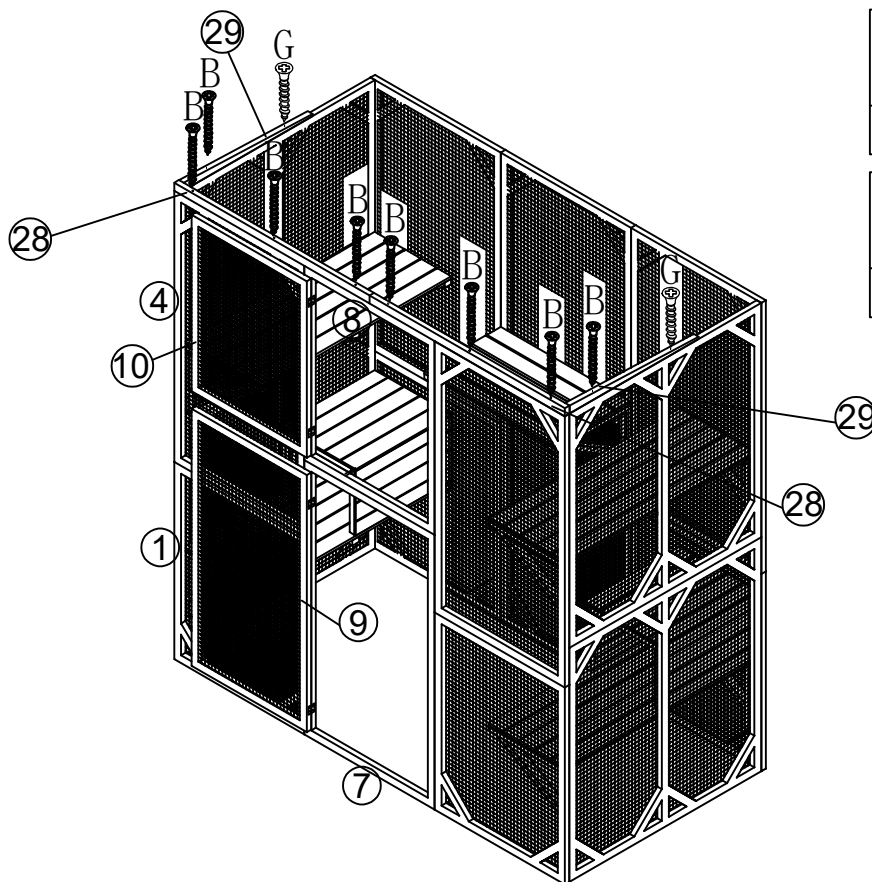

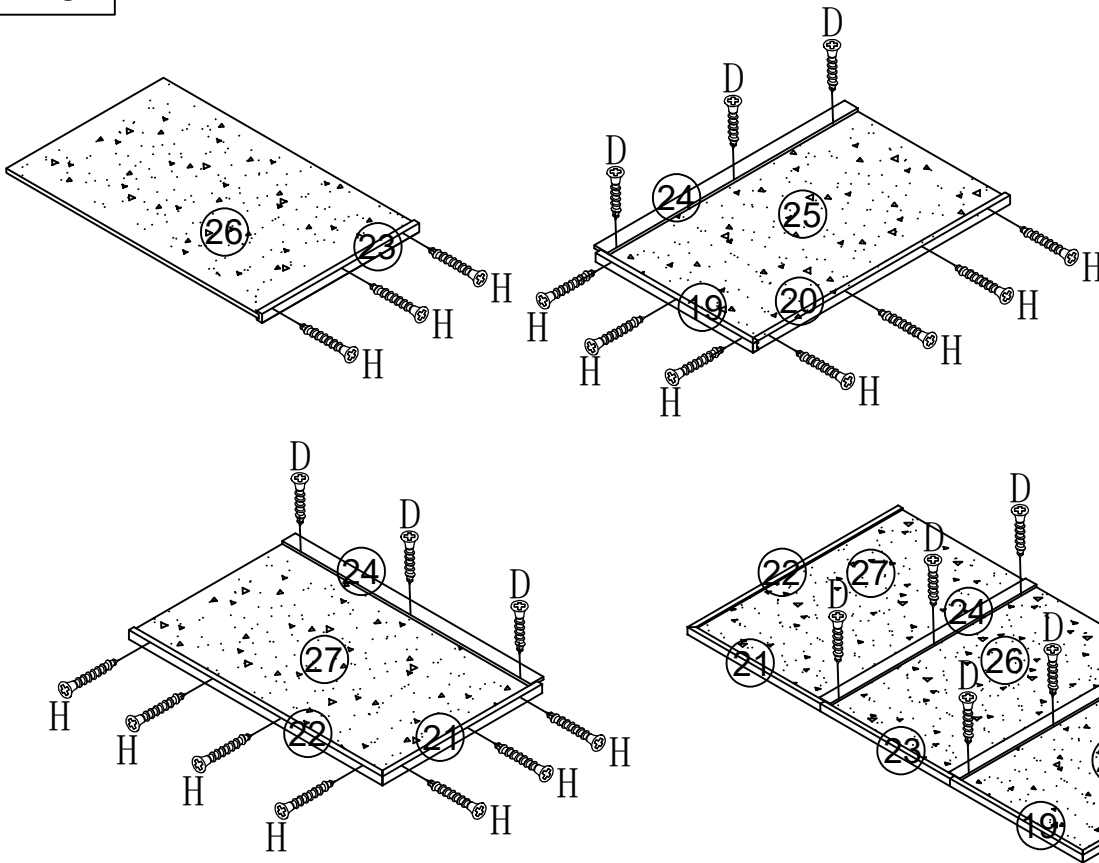

13

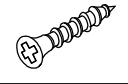
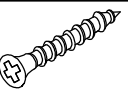

-  D x 12pcs
-  H x 17 pcs

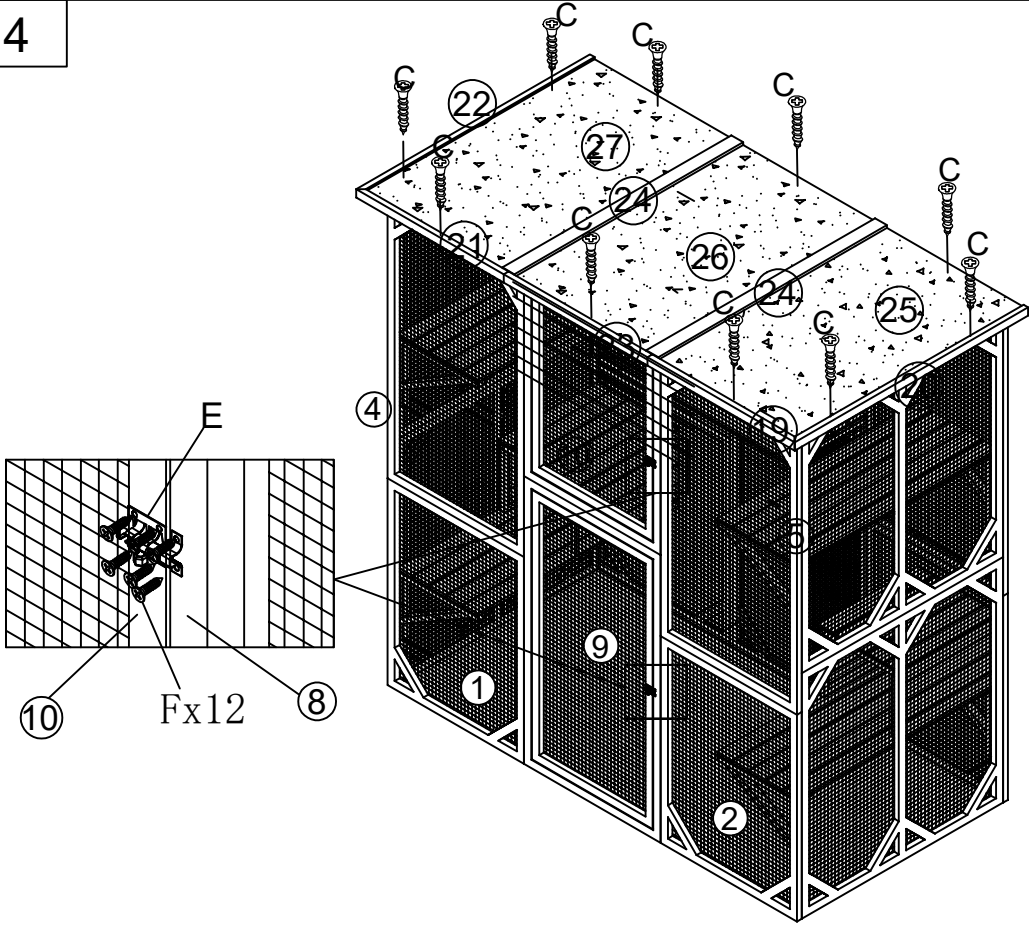
14

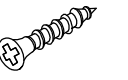

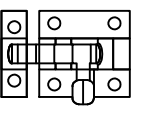
-  C x 10pcs
-  F x 12pcs
-  E x 2pcs