

ASSEMBLY INSTRUCTIONS

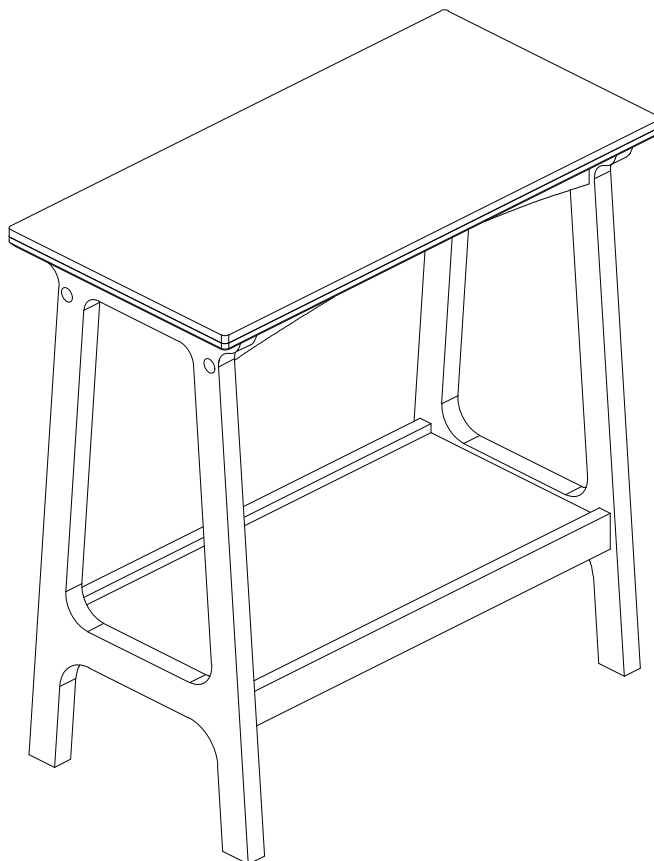

Notice:

1. Follow the installation instructions. Please confirm all accessories are preset before installation.
2. Do not fully tighten the screws during initial assembly. Fully tighten screws only once all pieces which are correctly assembled.
3. If you encounter any problems during installation, please contact our customer service.
4. Please unbox the item from the side with an open-label and put a carpet on the floor to avoid scratching it.

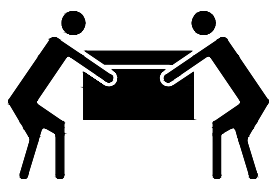

Recommended installers:2

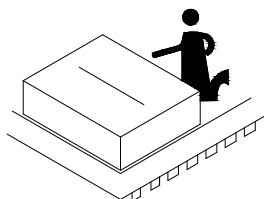

Put a carpet on the floor
before unpacking

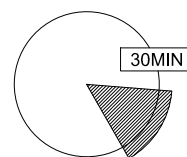



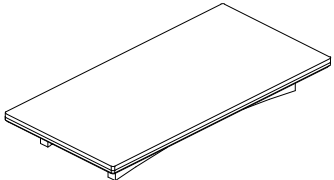
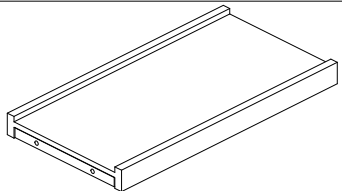
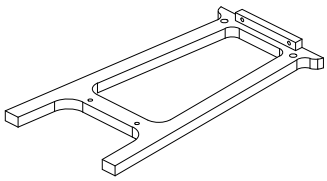

Estimate installation time:
30minutes

ASSEMBLY INSTRUCTIONS

PART LIST

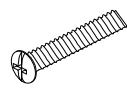
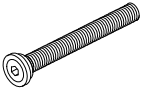
Item no.	Reference Image	Qty	Item no.	Reference Image	Qty
Ⓐ		X1	Ⓒ		X1
Ⓑ		X2			

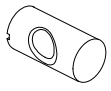
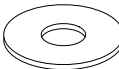
HARDWARE LIST

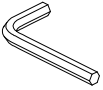
Item no.	Reference Image	Qty	Item no.	Reference Image	Qty
1	 Ø1/4"X1-1/8"	X8	5	 Ø1/4"X2"	X4
2		X8	6		X4
3		X8	7	 Ø13	X4
4		X1			

ASSEMBLY INSTRUCTIONS

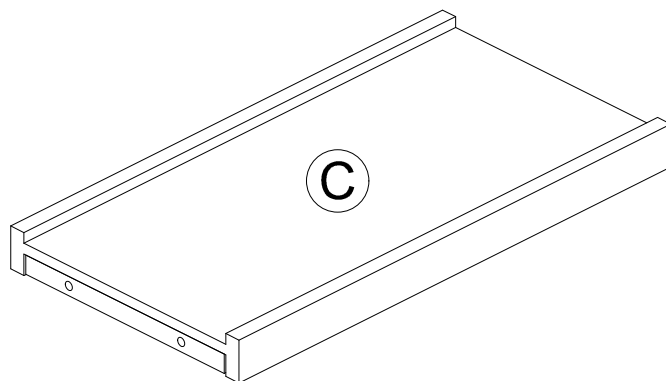
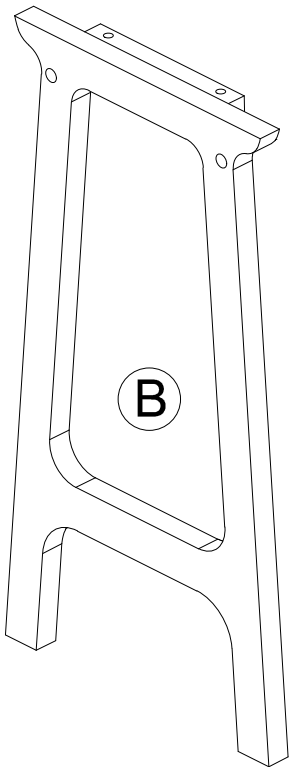
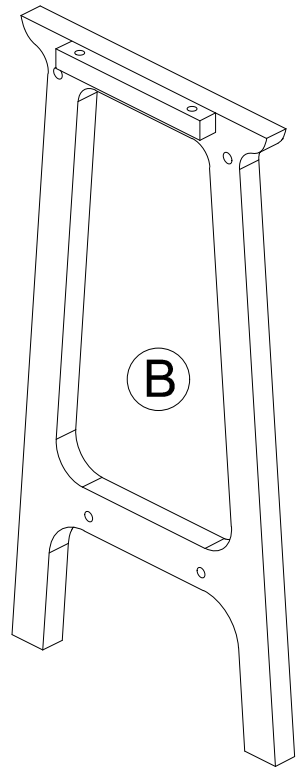
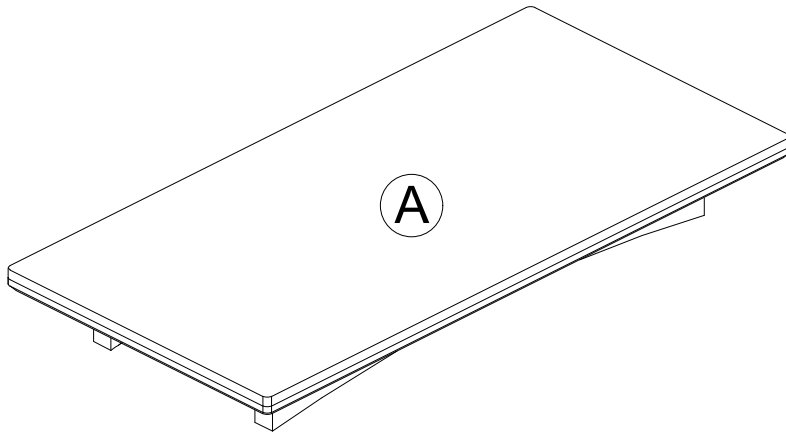

ASSEMBLY INSTRUCTIONS

1

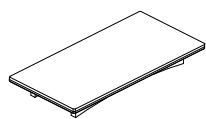

(A) 1pc

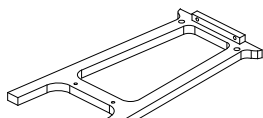

(B) 1pc

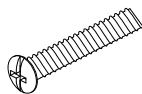

(1) 2pcs



(2) 2pcs



(3) 2pcs

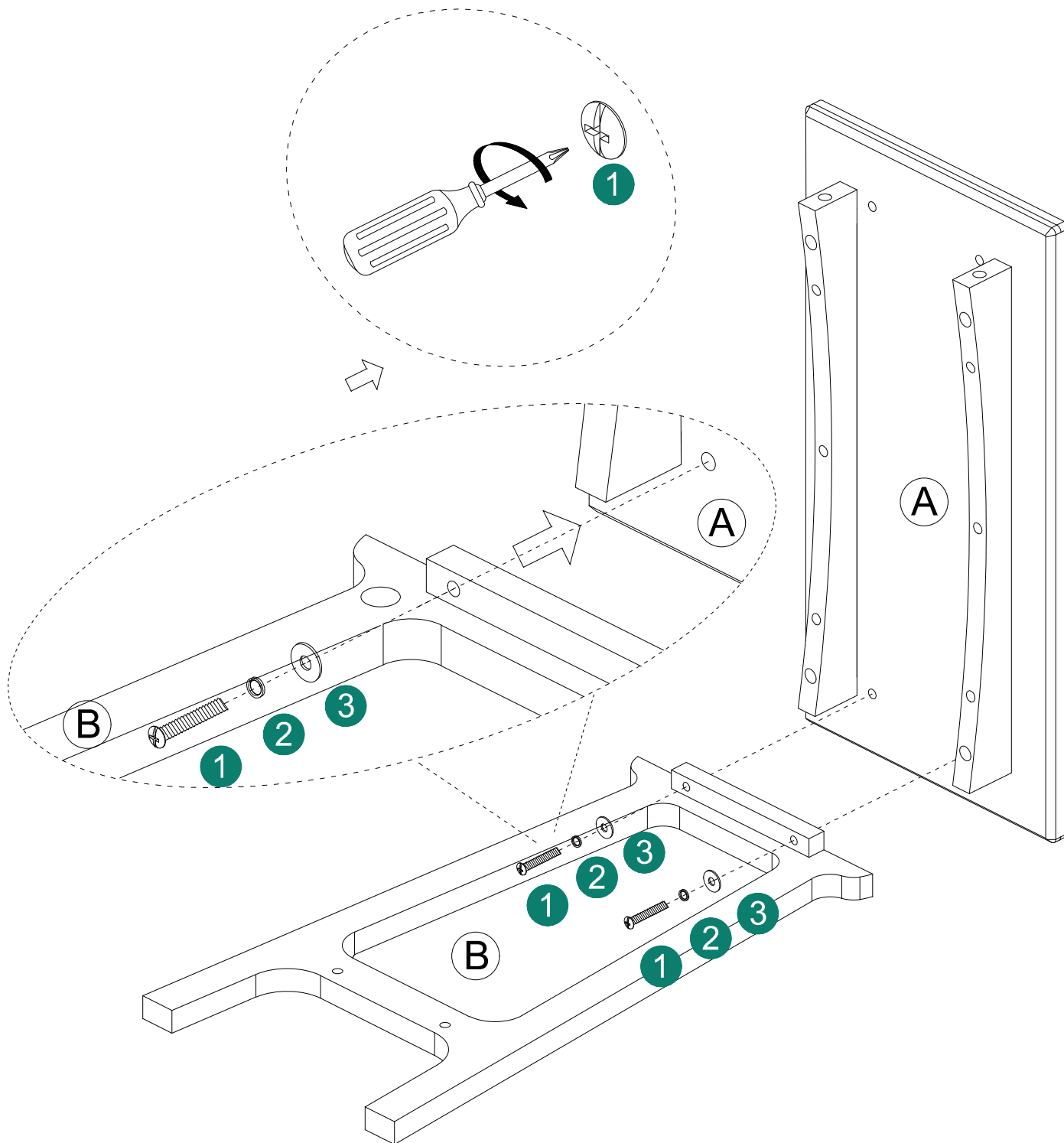

ASSEMBLY INSTRUCTIONS

2

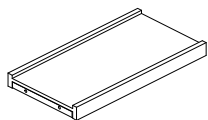

ⓐ 1pc

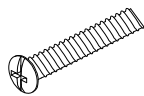

① 2pcs



② 2pcs

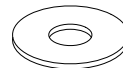

③ 2pcs

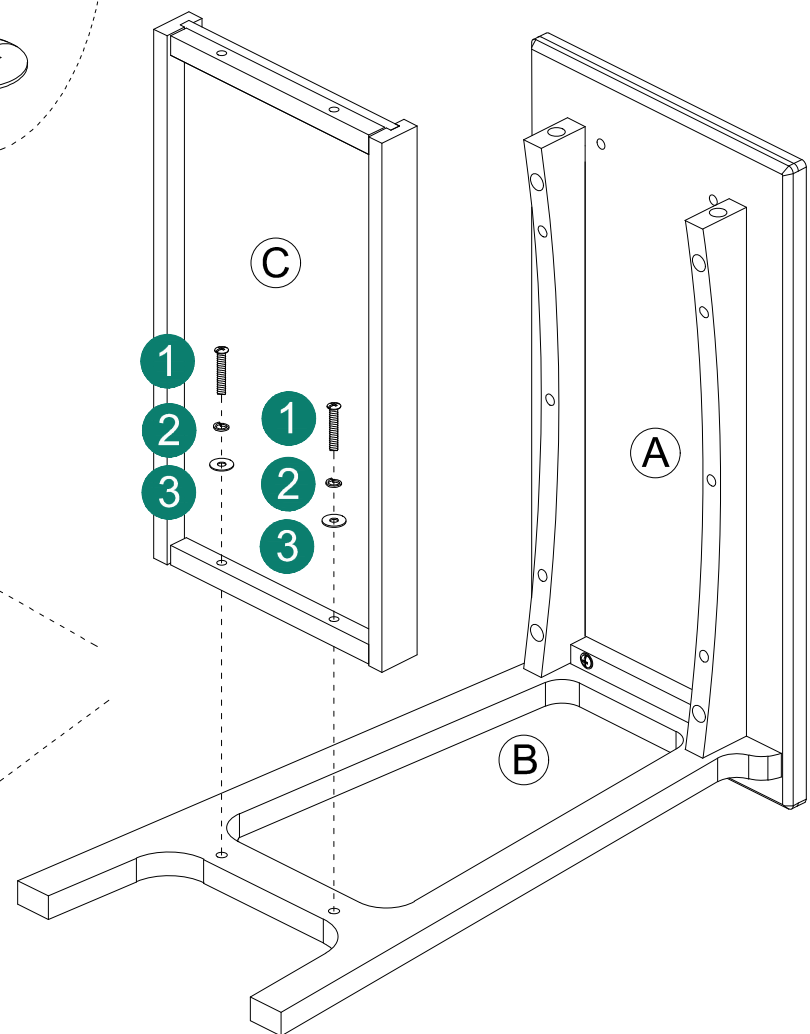
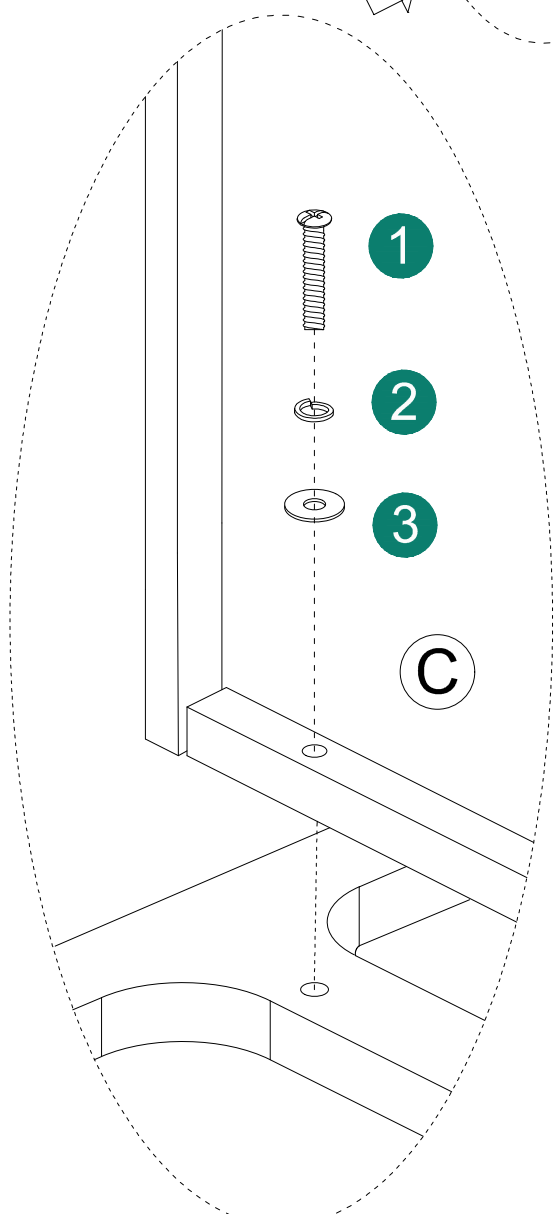
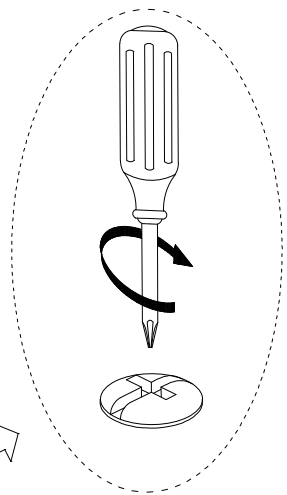

ASSEMBLY INSTRUCTIONS

3

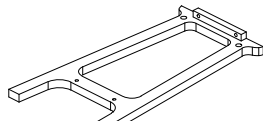

B 1pc

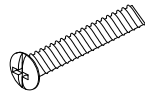

1 4pcs



2 4pcs

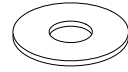

3 4pcs

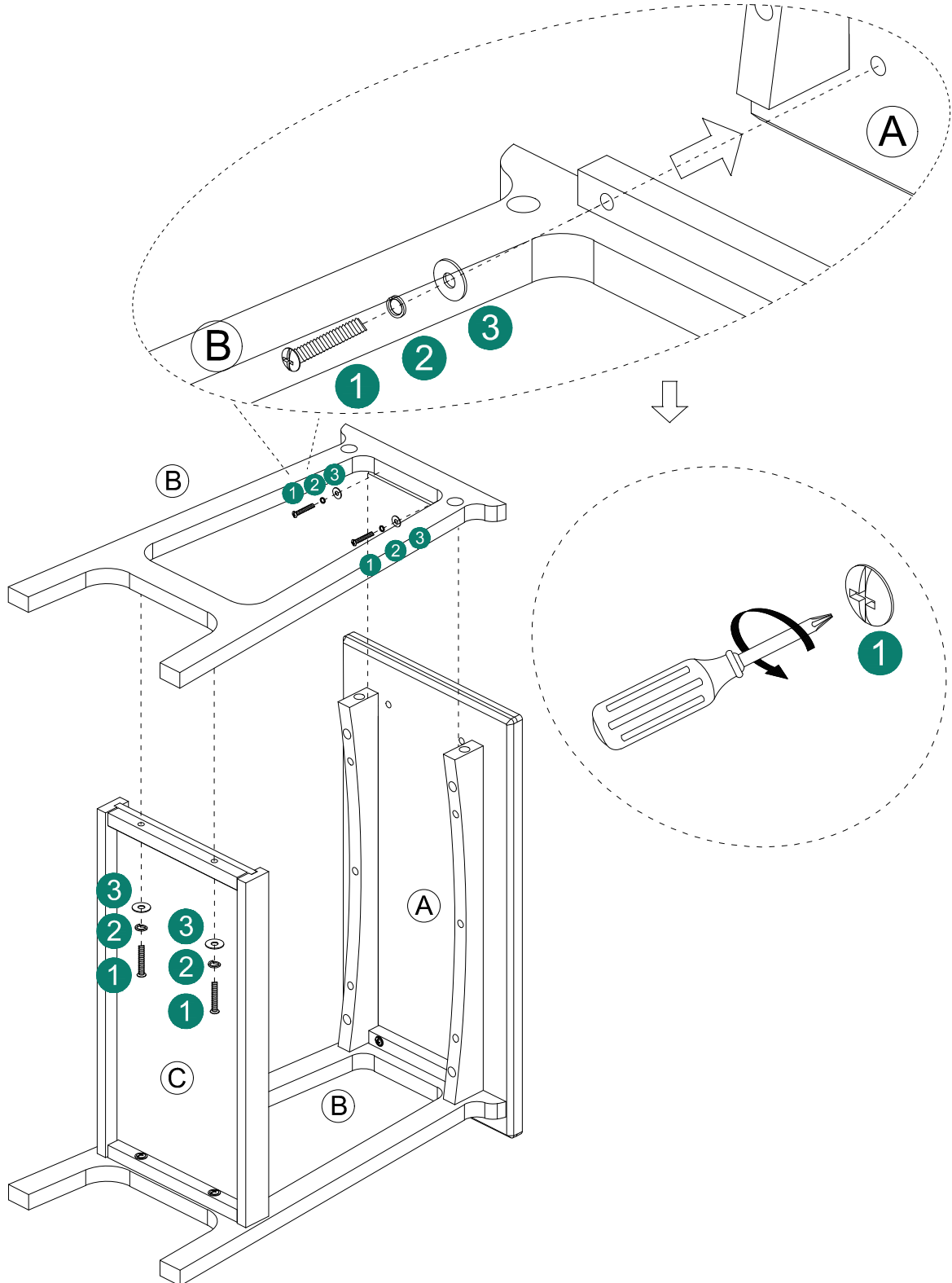

ASSEMBLY INSTRUCTIONS

4

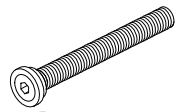

5 4pcs



7 4pcs

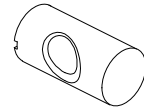

6 4pcs

