

Assembly Instruction

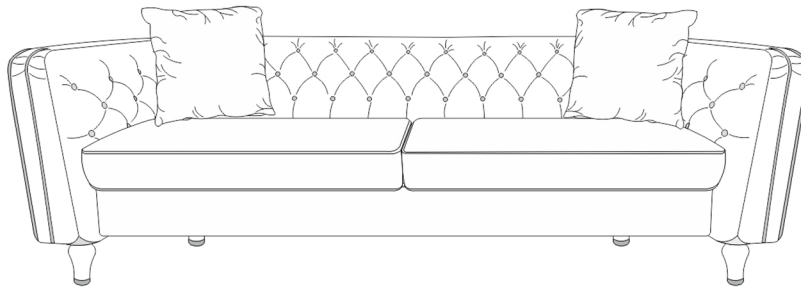

Box 1

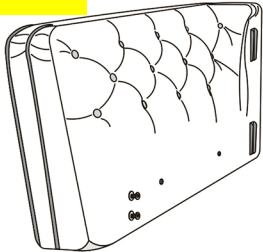

A.left armx1pcs

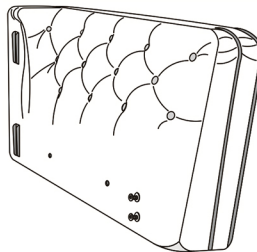

B.right armx1pcs

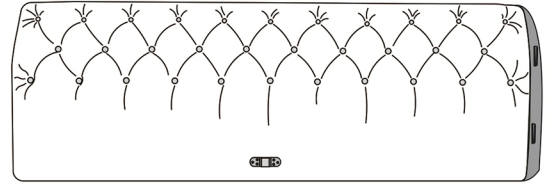

C.sofa back x1pcs



D.front boardx1pcs

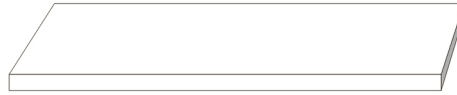

E.seat boardx1pcs



F.side barx2pcs

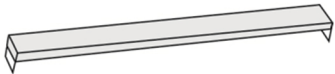

G.mid barx1pcs

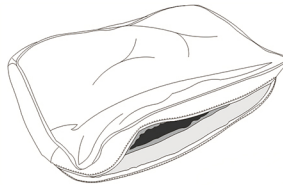

H.cushion coverx2pcs

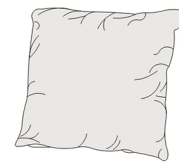

I.pillowx2pcs

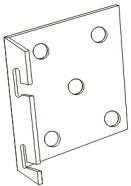

J.bracket(1)x1pcs

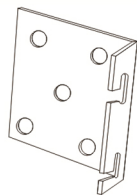

K.bracket(2)x1pcs



L.sofa legx4pcs

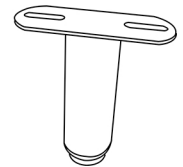

M.mid legx1pcs

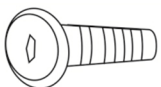

N.M6*20mmx12pcs

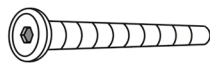

O.M6*70mmx4pcs

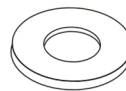

P.washerx6pcs



Q.hex keyx1pcs

Box 2

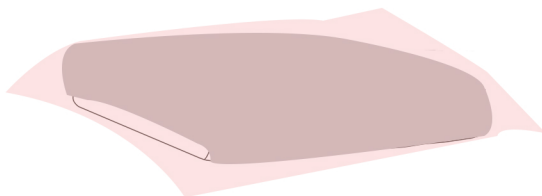

R.compression seat cushionx2pcs

Step 1. Insert the sofa back(C) to the left arm(A).

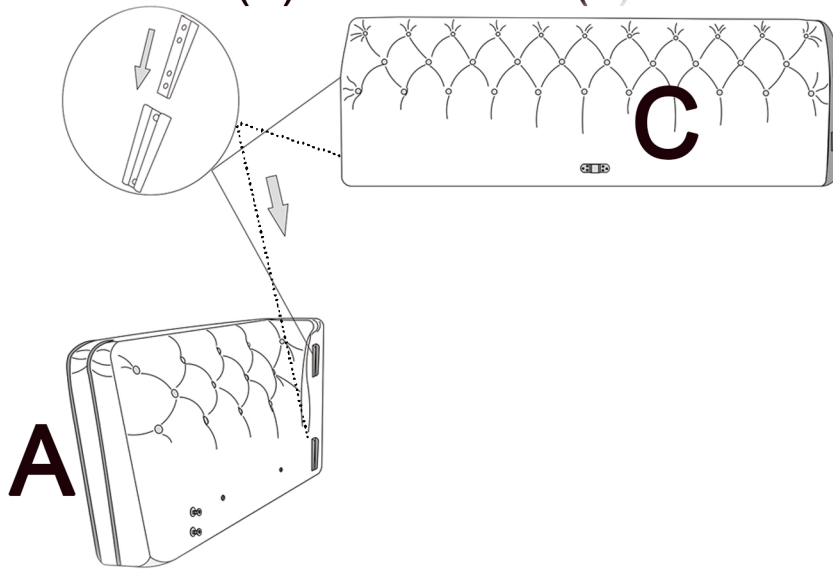

Step 2. Insert the sofa back(C) to the right arm(B).

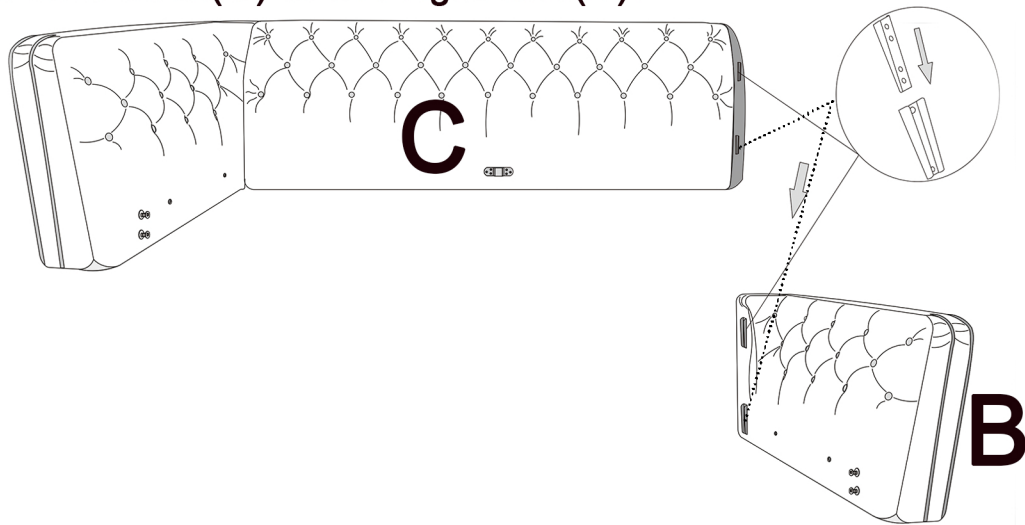

Step 3. Install the bracket J and K to both side of front board(D)

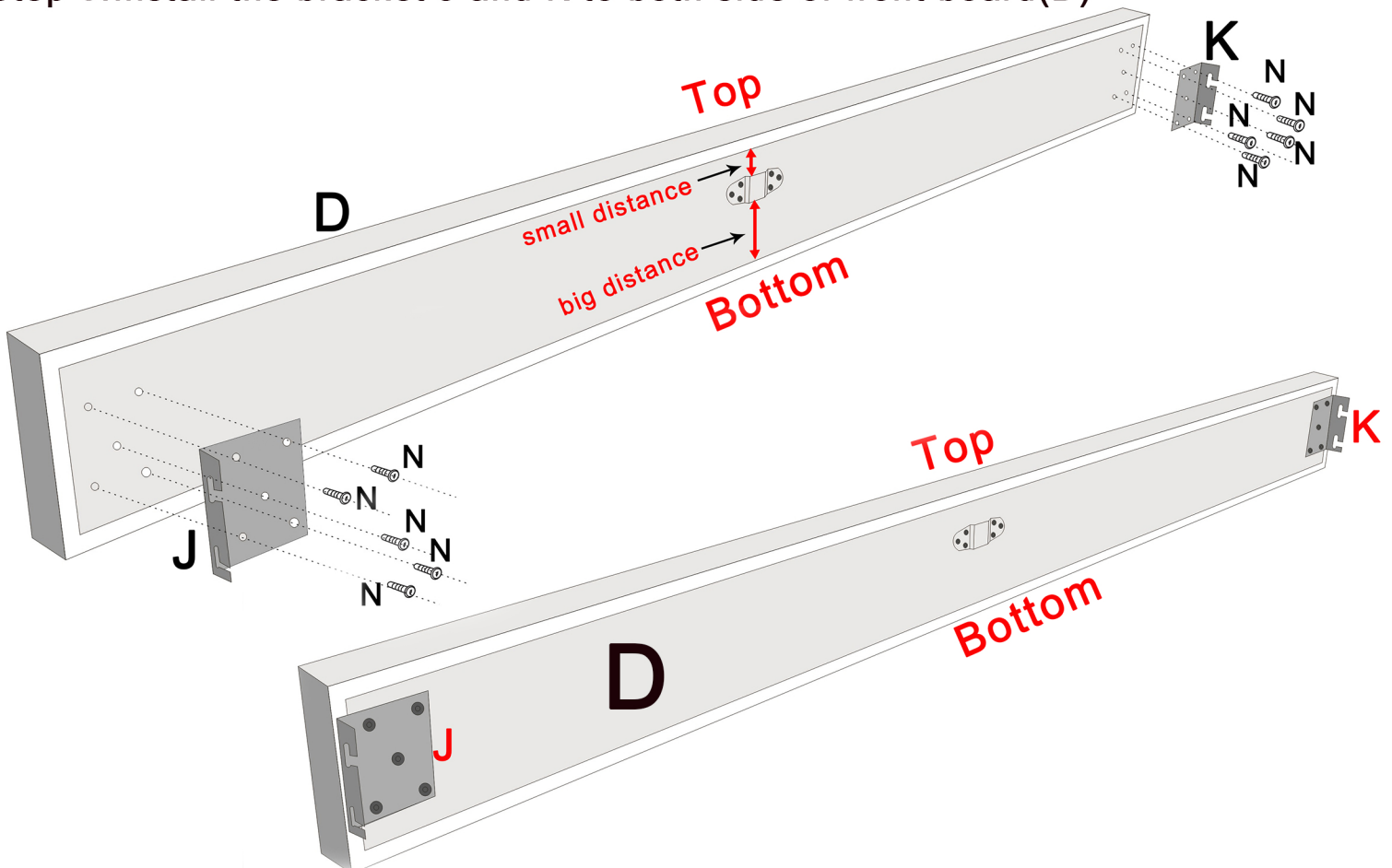

Step 4. Install the front board(D) and fasten to both armrest(A and B)

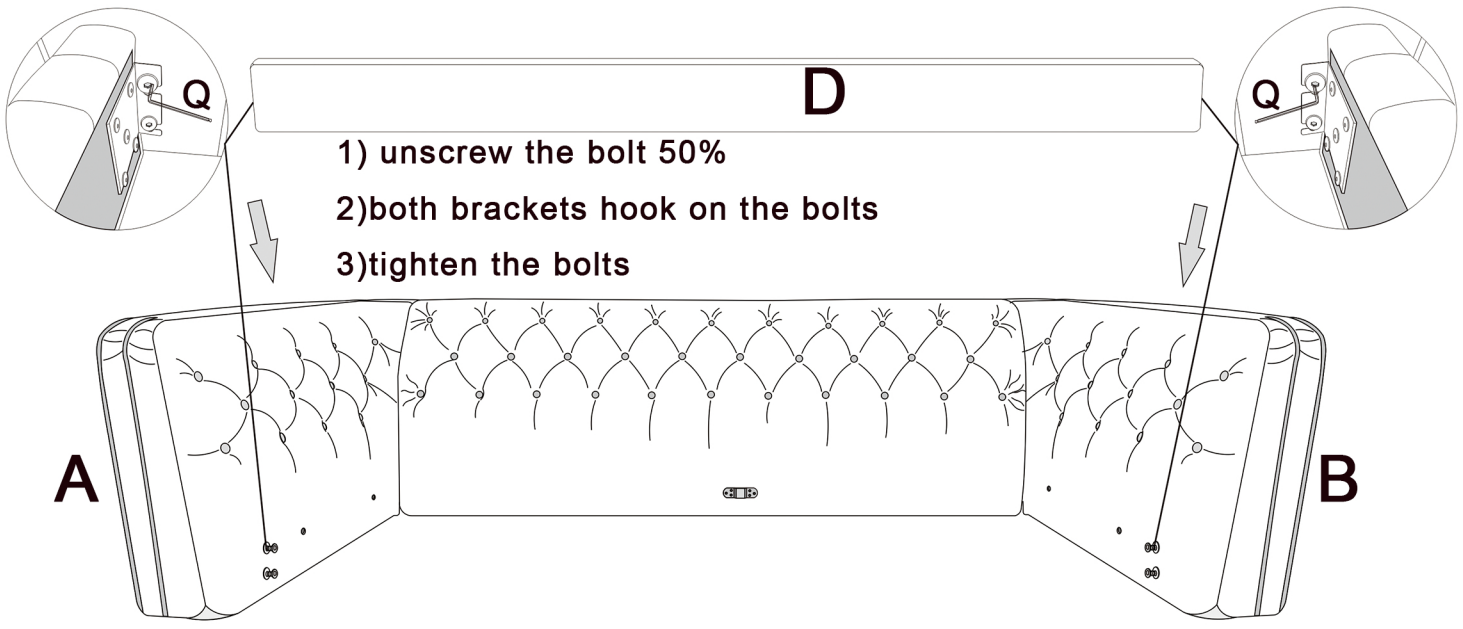

Step 5. Install the side bars(F) to both armrest(A and B).

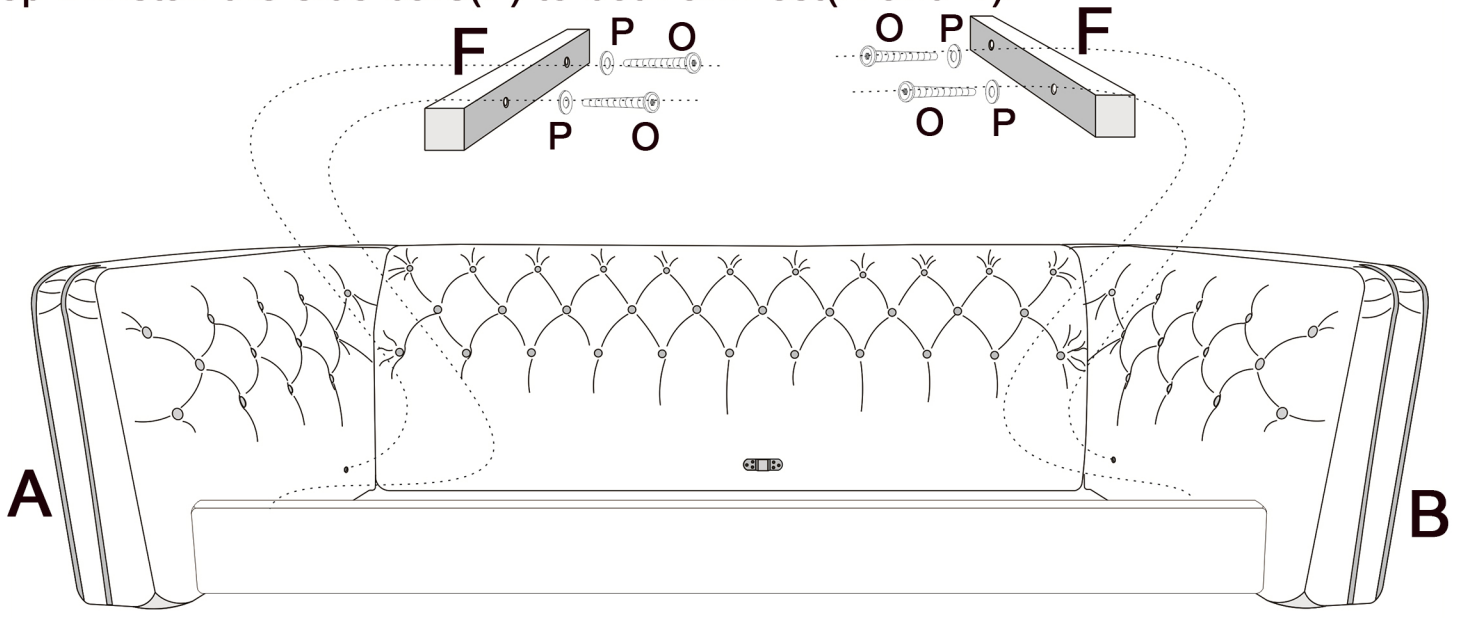

Step 6. Install the mid bar(G) to the front board(D) and sofa back(C).

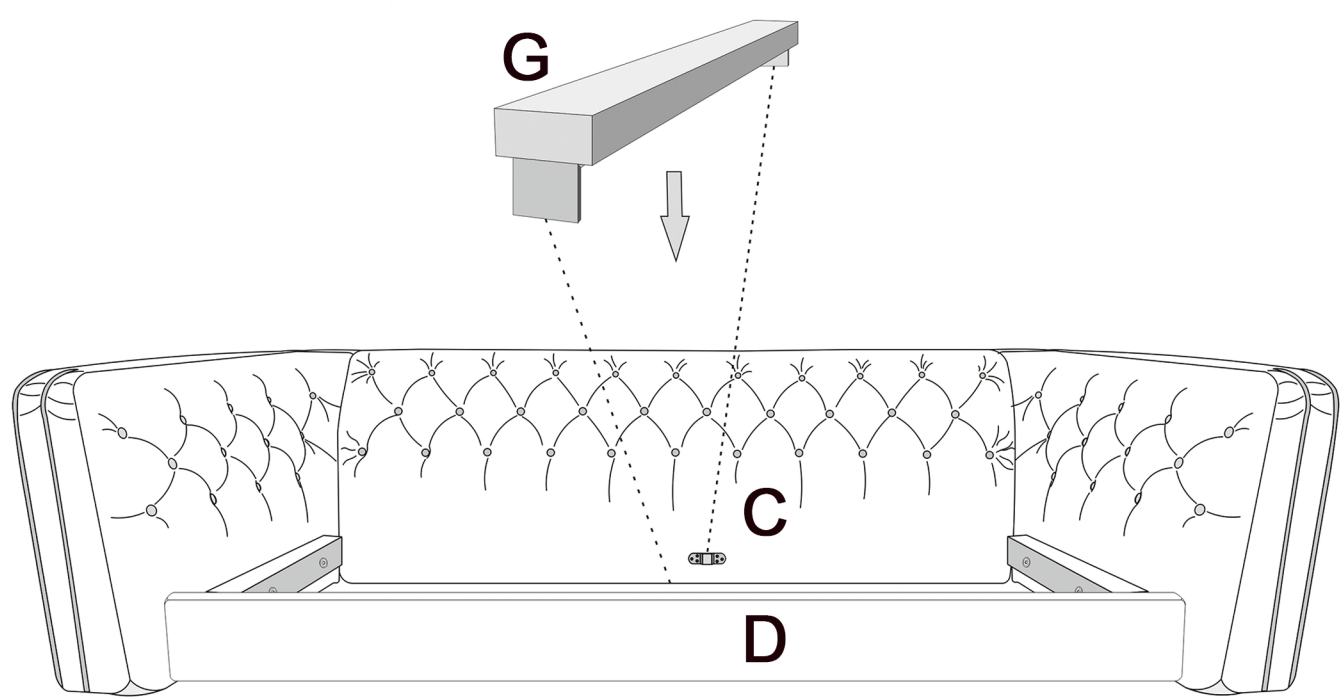

Step 7. Install the sofa legs.(L)

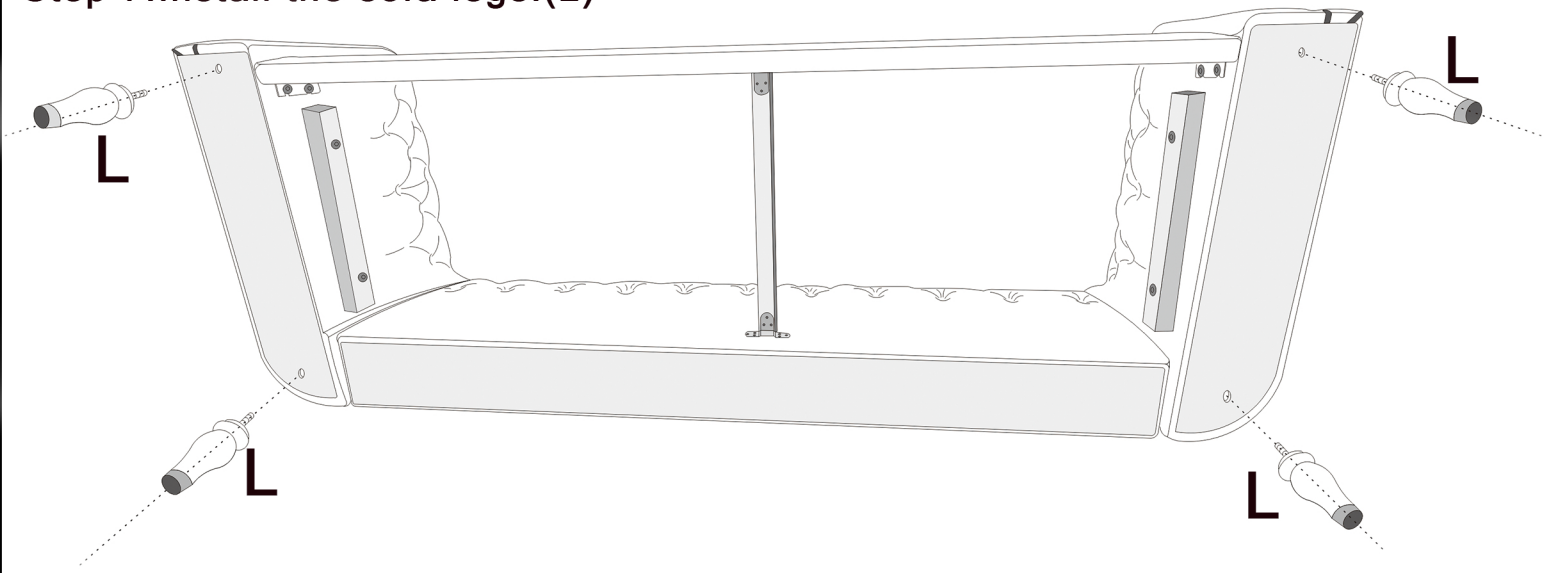

Step 8. Firstly, install the mid leg(M) on the seat board(E), and adjust the height of the mid leg, then put the seat board(E) on top of the side bar(F) and mid bar(G).

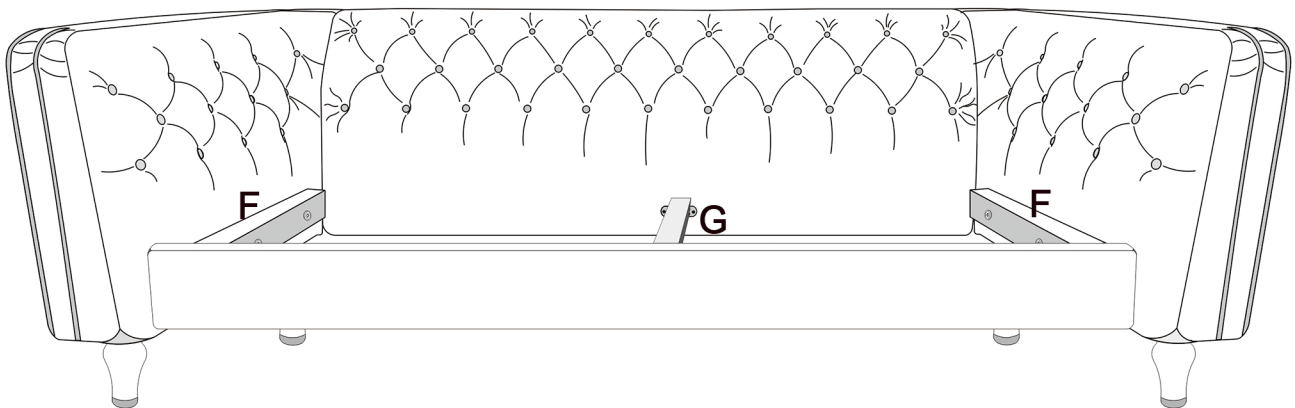
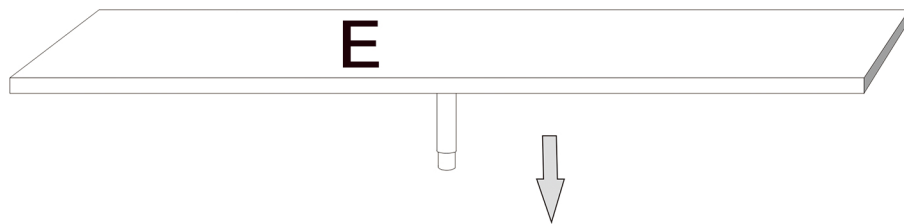
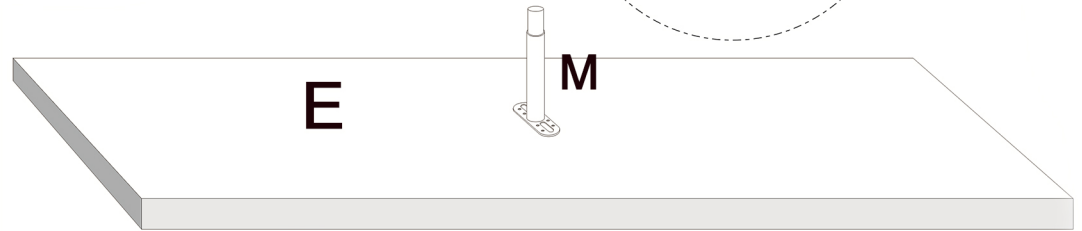
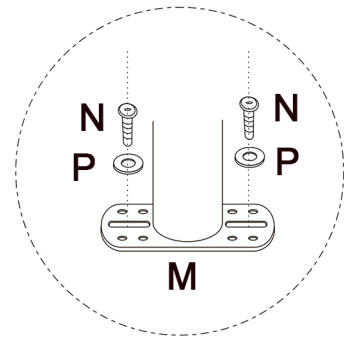

Step 9. Put the seat cushions on the seat board.

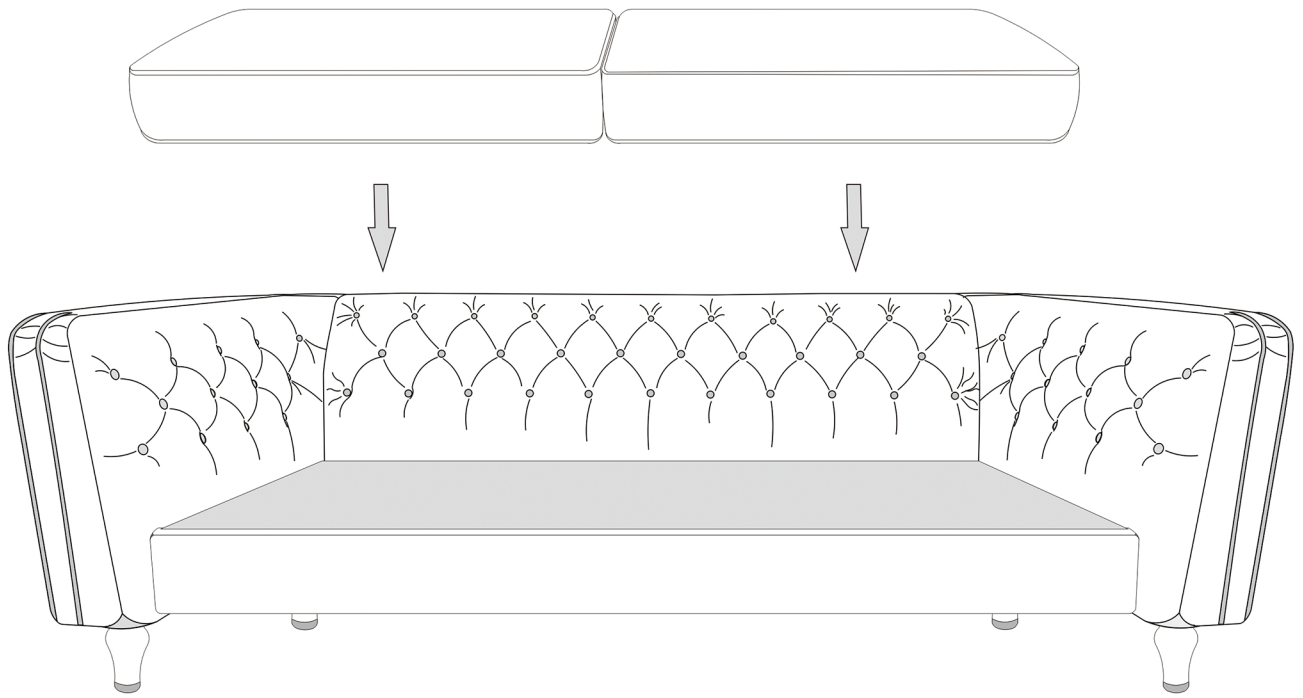

Step 10. Put the pillows (I) on the sofa.

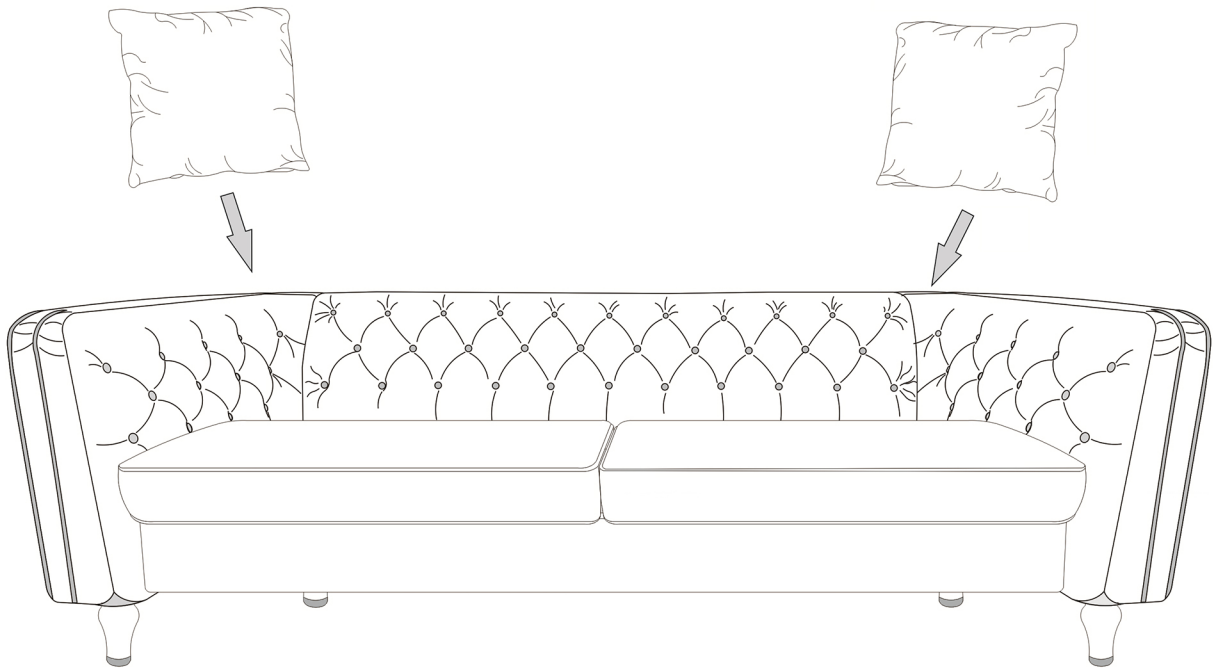

Finish

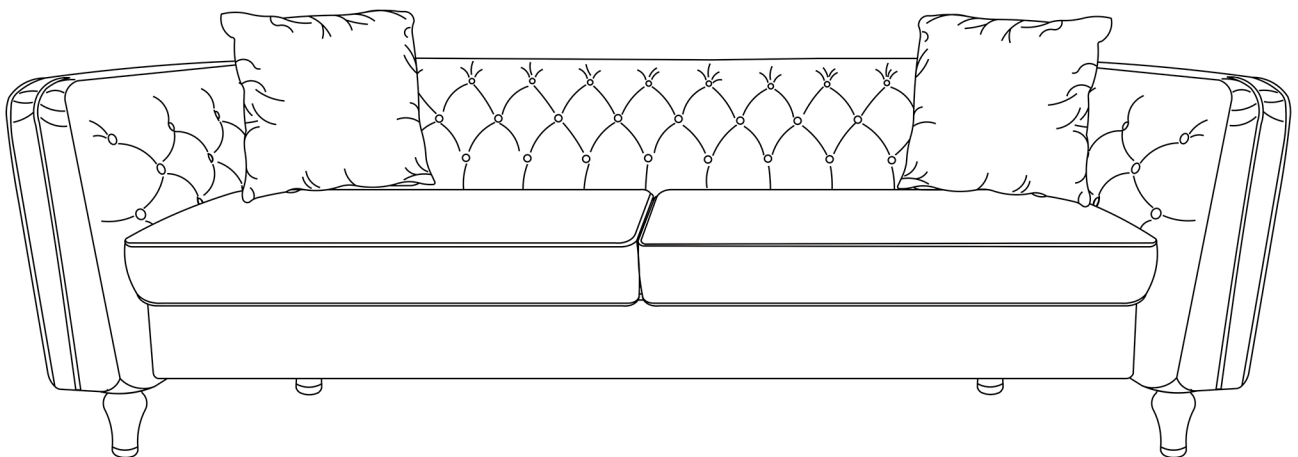

How to install the cushions

Step 1. Open the plastic bag and remove the cushions foam wrapped with polyester fiber&Non-woven bags from the plastic bag.

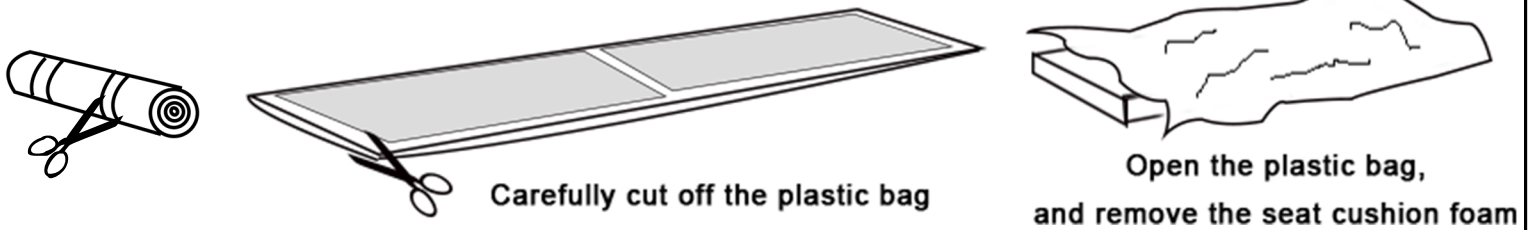

Step 2. Cover the fabric covers to all seat cushions. **PLEASE DON'T REMOVE THE NON-WOVEN BAG & POLYESTER FIBER OF THE SEAT CUSHIONS, PLEASE KEEP IT AS IT IS.** When you get the seat cushion, you will see the RED words which side is the **Top**, **Front** and **Back** as following.

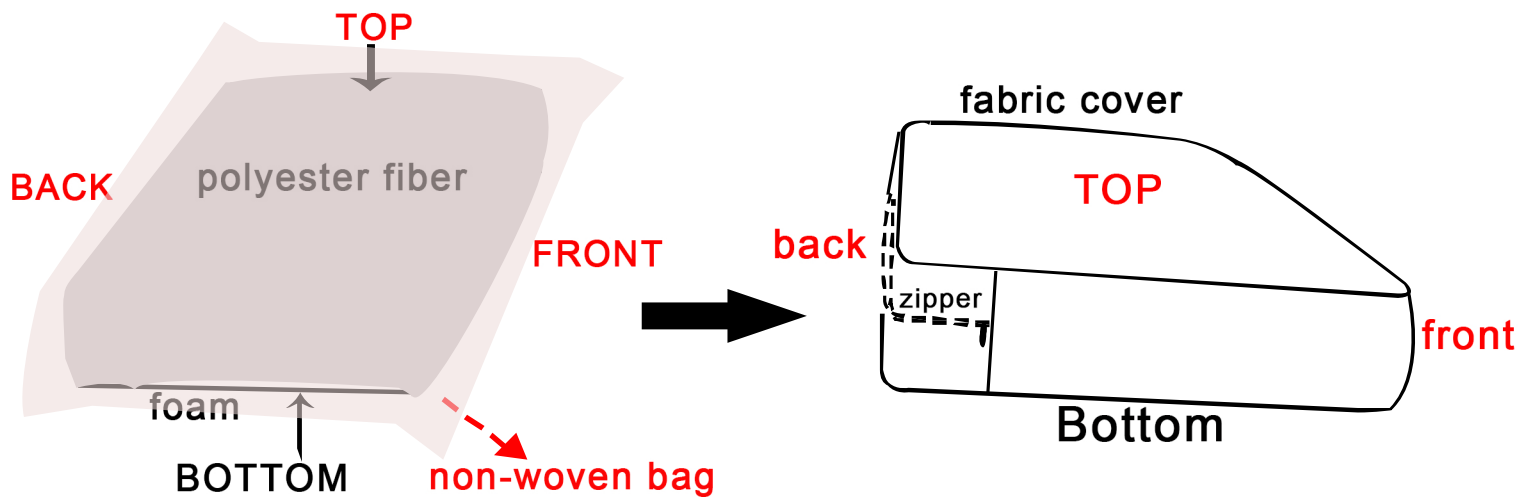

How to tidy sofa seat cushion?



TIPS

At the beginning all cushions are a little loose which is normal. Please allow at least 72 hours for all cushions foam to recover to its natural state after covering the fabric covers.