

# ASSEMBLY INSTRUCTION

A\*1

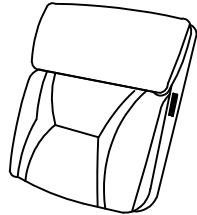

B\*1

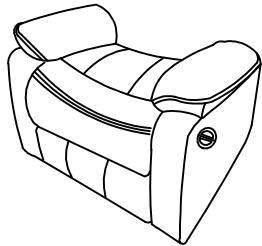

C-L\*1

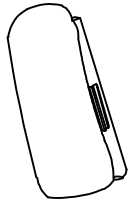

C-R\*1

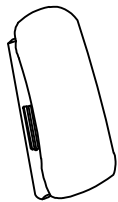

C-L



A

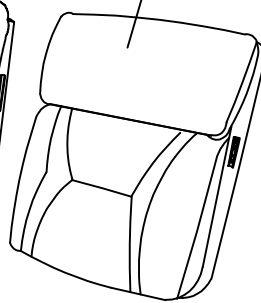

C-R

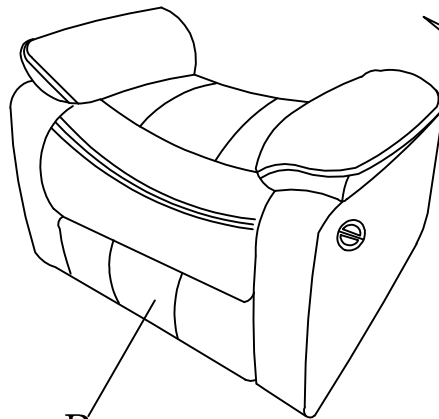
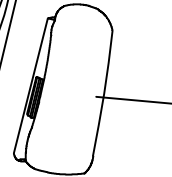

B

