

Warranty

Our barstool comes with a 1- year warranty from the date of purchase. In any circumstance that the product arrives damaged or missing parts. We are more than happy to provide you with replacement part.

Warm tips

Please read the instructions carefully before assembly and make sure you have the parts & hardware as identified on the list.

It is highly recommended to assemble the chair on a soft clean surface to avoid scratches.

Modern Barstool

Model: 2052



Parts List

① Back Cushion

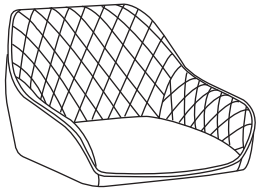

② Rear Leg

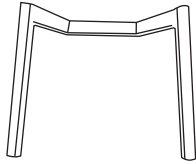

③ Front Leg

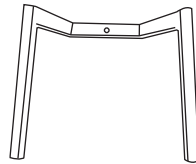

④ Leg X4

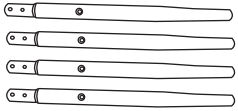

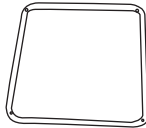

⑤ Foot Ring



Hardware Kit

A1 Bolts(M6*12mm)  8

A2 Bolts(M6*35mm)  1

A3 Bolts(M6*30mm)  4

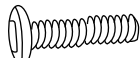
A4 Bolts(M6*50mm)  4

B Allen Key  1

Step 1:

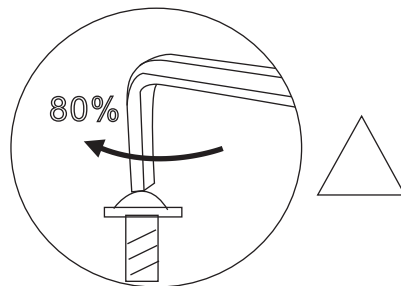
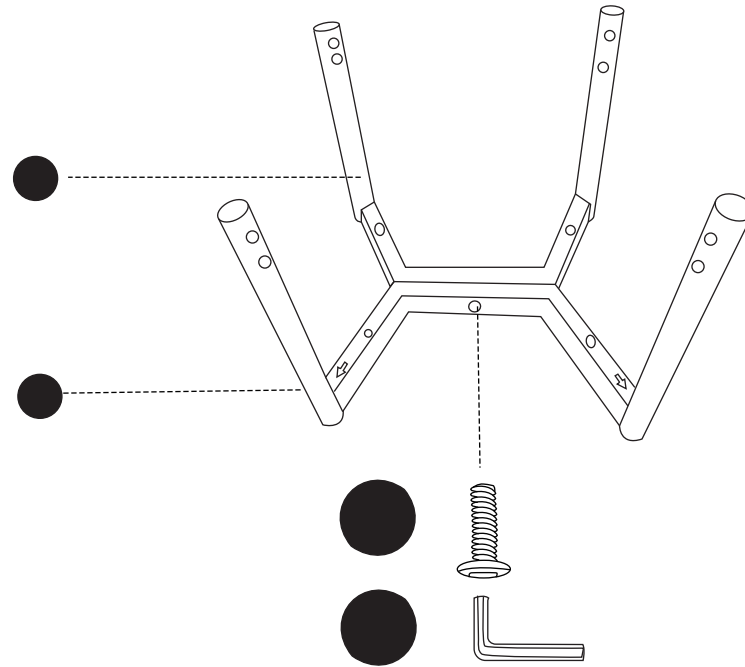

Step 2:

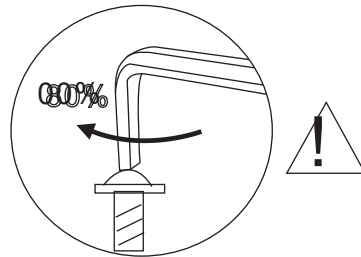
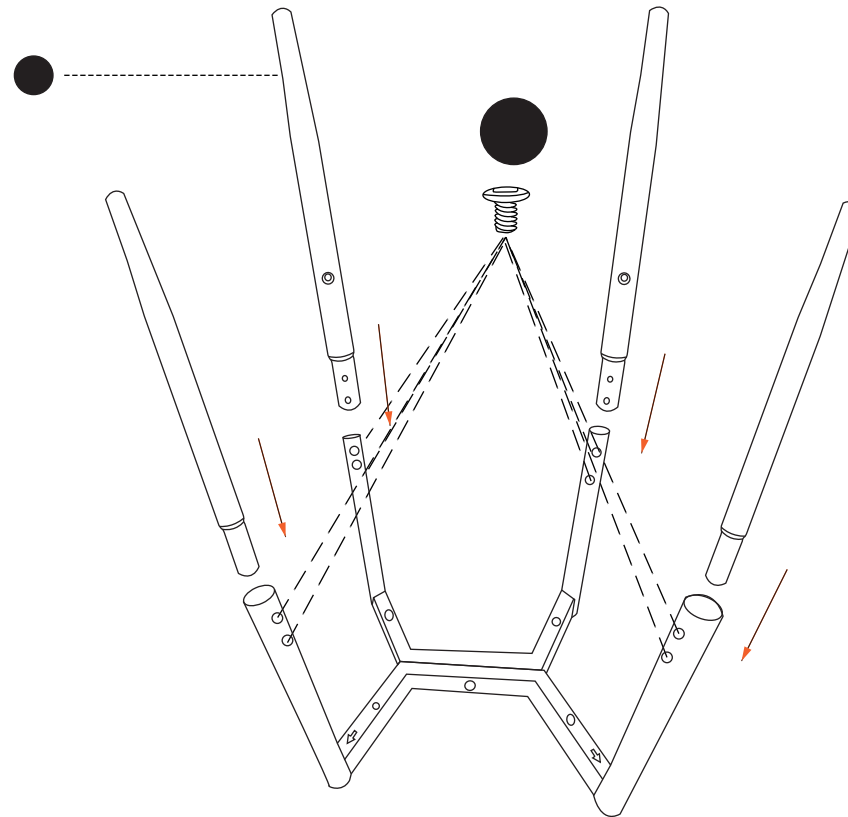

Step 3: Connect the Foot Ring to the Frame with Screw. Then Tighten Them By 80%. Make Sure the Frame is Levelled On the Ground. Then Tighten All the Screw by 100%.

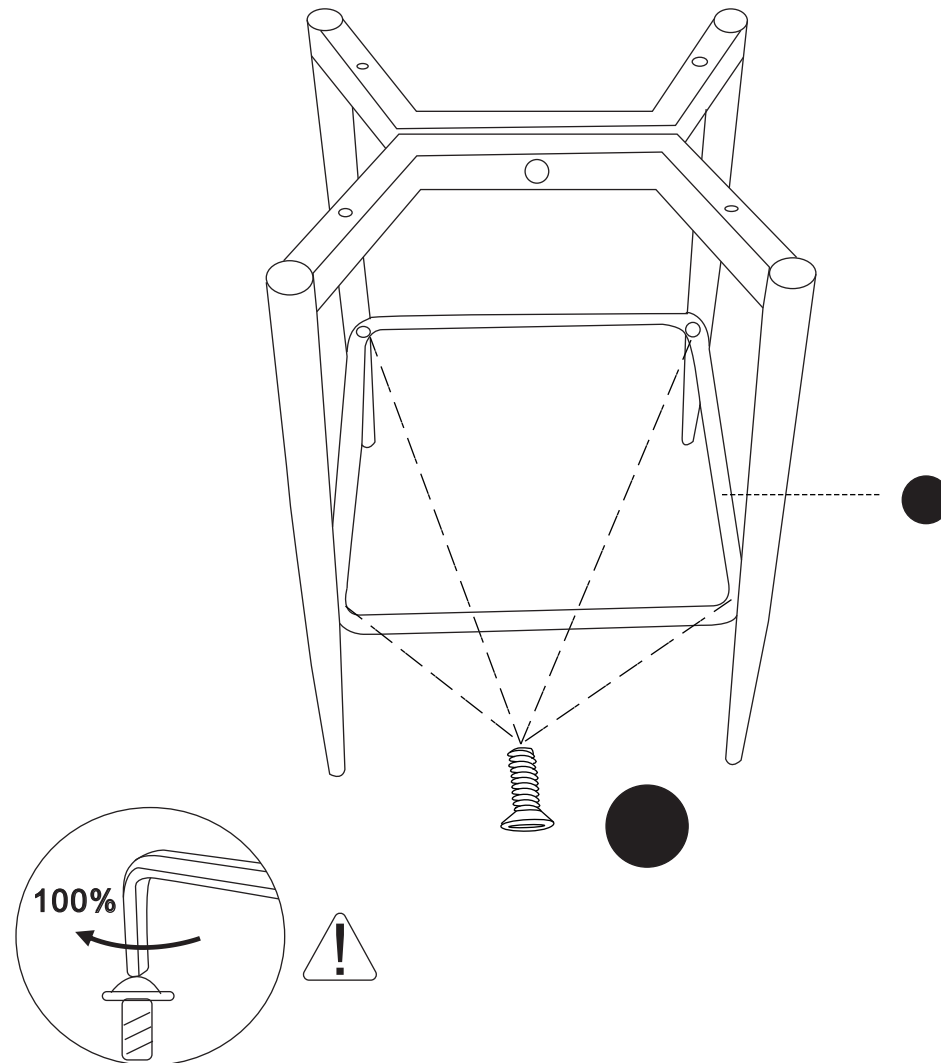

Step 4:

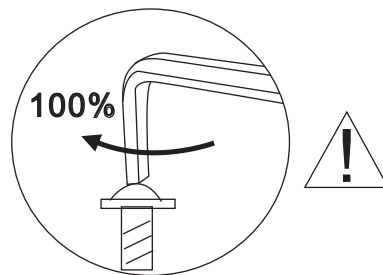
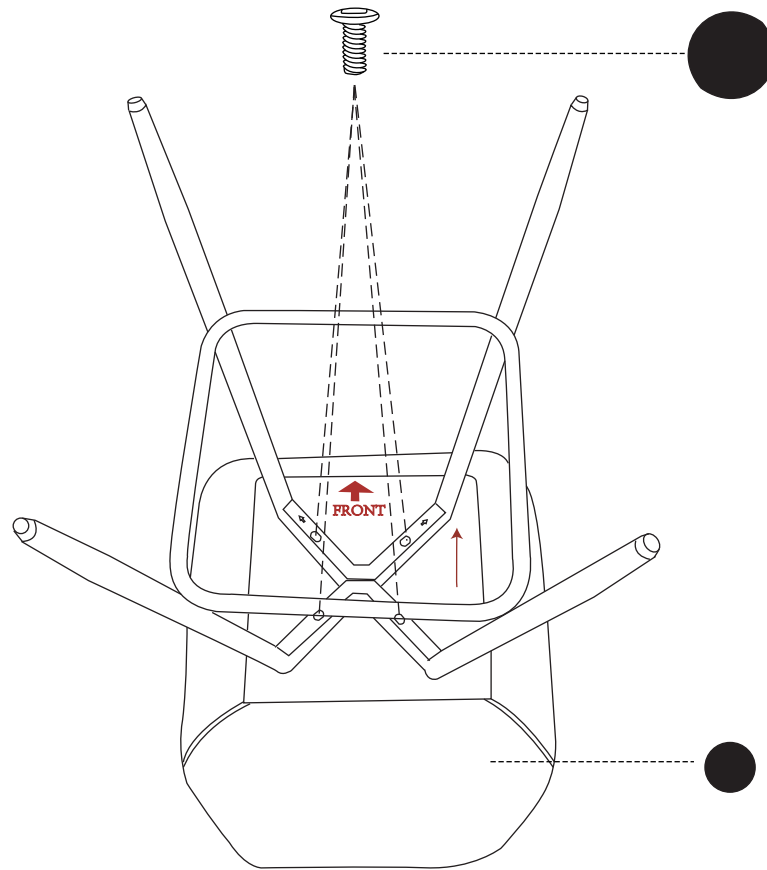

Step 5: Adjust the barstool footpad height to ensure the chair seamlessly aligns with the ground, enhancing your comfort and stability during use

