

NOTICE

* Please make sure that you have all parts indicated and they are in good condition before you begin assembly of this item. Refer to part list and hardware list below for guidance.

* This item should be assembled on soft surface to prevent scratching the finish during assembly.

* This item may require periodic tightening.

* If you re having difficulty, our friendly Customer Care team is always here to help

PREPARATION

* Before beginning assembly of product, make sure all parts are present. Compare parts with package contents list and hardware content list.

* If any part is missing or damaged, do not attempt to assemble the product.

* Estimated Assembly Time : 10 minutes

* Tools Required for Assembly (included) : Allen Key

CARE AND MAINTENANCE





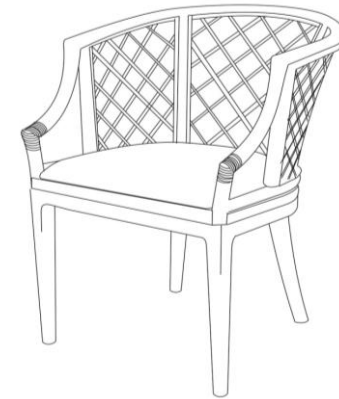

Spot clean using a mild water-free solvent. Only a professional cleaner should undertake a complete overall cleaning.

The use of steam or water-based cleaners may cause excessive shrinking or staining.

Product Dimensions : 22" x 23.25" x 31.5"



Part List and Hardware List

PIECE	DESCRIPTION	PICTURE	QUANTITY
A	SEAT & BACK		1X
B	LEG		1X
C	CUSHION		1X
HW1	Hex Bolt 8x1x50 mm		4X
HW2	Flat Washer 9mm		4X
HW3	Key Pass		1X



Weight Capacity : 275 lbs

WARNING : DO NOT STAND ON CHAIR

WARNING : DO NOT OVER TORQUE BOLTS

PREPARATION

- * Before beginning assembly of product, make sure all parts are present. Compare parts with part contents list and hardware content list.
- * If any part is missing or damaged, do not attempt to assemble the product.
- * Estimated Assembly Time : 10 minutes
- * Tools Required for Assembly (included) : Allen Key
- * If you are having difficulty, our friendly Customer Care team is always here to help

Hardware is located inside the box. You can find them placed near the sign "HARDWARE INCLUDED"

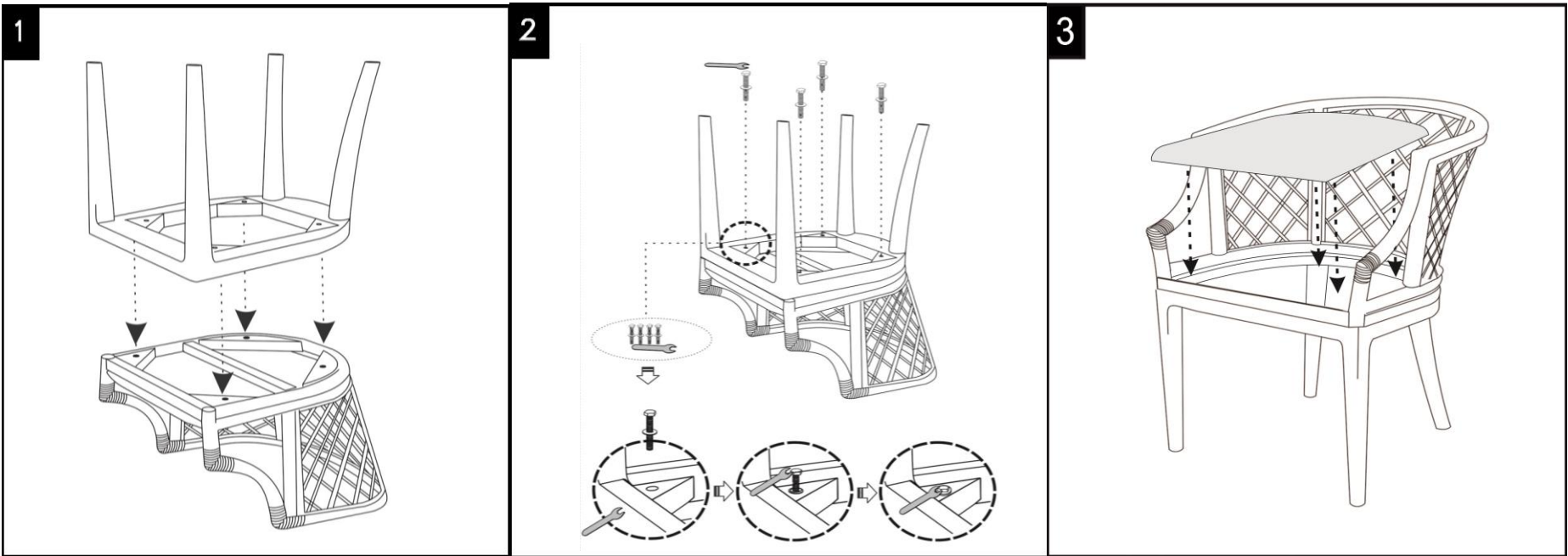

STEP 1 :
Put part A upside down in smooth surface.
Carpet is better.

STEP 2 :
Assembly part A and B with Nuts and tighten
with Key Pass

STEP 3 :
Put the cushion