



To avoid the risk of fire, explosion, or electric shock, this product should be installed, inspected and maintained by a qualified electrician only, in accordance with all electrical codes.

To avoid electric shock:

Be certain electrical power is OFF before and during installation and maintenance
Luminaire must be connected to a wiring system with an equipment-grounding conductor.

To avoid explosion:

Make sure the supply voltage is the same as the rated luminaire voltage
Do not install where marked operating temperatures exceed the ignition temperature of the hazardous atmosphere
Do not operate in ambient temperatures above those indicated on the luminaire nameplate

Suitable for use in the following locations:

Ambient temp: -20° ~ +40°C (-4° - 104°F)
Wet locations

What's In The Box

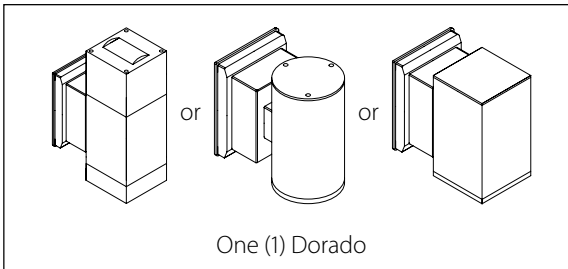

Tools Needed

A screwdriver, drill, a pair of wire strippers, hex key, and 4 fasteners appropriate for the mounting surface will be needed to install the Dorado.

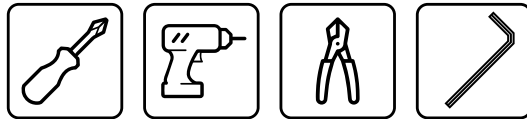

- 1 Carefully unpack fixture from packaging and inspect for any damage caused in shipping.

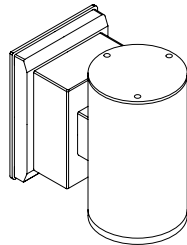

- 2 Turn off power using appropriate switch/breaker.

- 3 Locate desired positioning for the fixture on the wall surface.

- 4 Flip over fixture and remove the mounting plate from the fixture by using a hex key (1/8") to loosen the set screws (2), (do not remove set screws.)

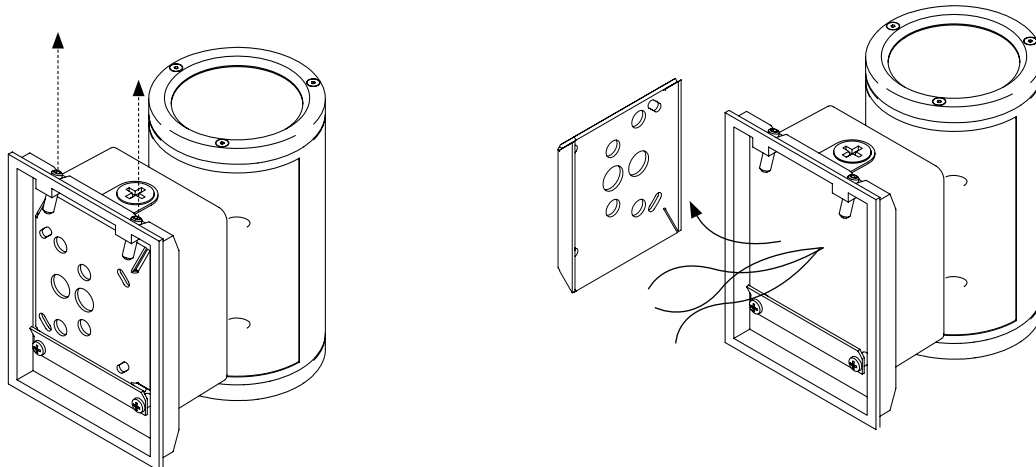

- 5** Secure mounting plate to the J-Box with (4) screws (by others).

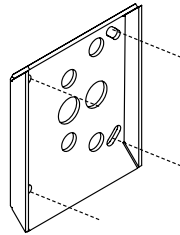

- 6** Hold luminair close to mounting location and connect wiring as shown in wiring diagram.

- 7** Attach the fixture (with set screws pointing down) over the mounting bracket and tighten the set screws (2) with the hex key (1/8").

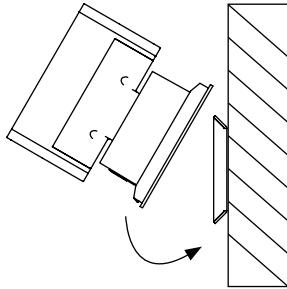

- 8** Use silicone caulk (by others) to seal where fixture meets the wall. (recommended)

- 9** Check that fixture is firmly attached to mounting surface

- 10** Energize fixture and verify that the fixture is lit

IMPORTANT: To weather-proof your outdoor installation, be sure to seal all mounting points, wire inlets, and penetrations (Conduit, Plugs, etc.) with silicone sealant.

Wiring Diagram

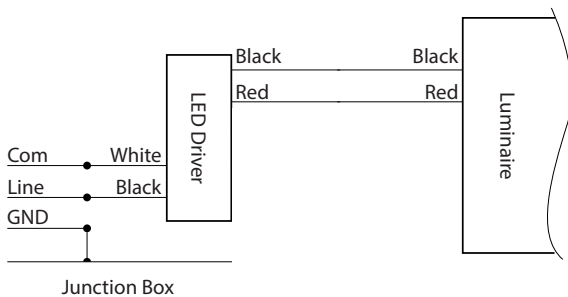

EXPRESS LIMITED WARRANTY

Subject to the exclusions contained below, NICOR Inc. (NICOR) warrants that all NICOR LED branded Solid State Lighting products made by NICOR to be free from defects in materials and workmanship, under normal consumer usage for a period of 5 years from date of purchase. This limited warranty is a consumer's exclusive remedy, and applies only to new products purchased and used by consumers in the United States or Canada, which are accompanied by this written warranty.

This limited warranty extends only to the first consumer purchaser, and is not transferable. A consumer wishing to invoke the terms of this warranty must first obtain a RGA number within 30 days of discovery of the defect, and return the product to NICOR for inspection. Once verified to be covered by this limited warranty, NICOR will, at its discretion, repair, replace or refund the purchase price of any product that does not conform to this limited warranty.

This limited warranty covers only defects in material and workmanship associated with normal installation and intended use of the product.

THIS LIMITED WARRANTY DOES NOT COVER THE FOLLOWING:

- Defects or damages resulting from improper operation, storage, misuse or abuse, accident or neglect;
- Defects or damages resulting from improper service, testing, adjustment, installation, maintenance, alteration, connection to out-of-specification electrical service, corrosive or damp environments, or connection to incompatible equipment or devices (e.g., connecting non-dimmable lighting products to dimmers);
- Damage which occurs in transit; and
- Labor or other charges or expenses associated with the removal, repair, or re-installation of defective or replacement products.

ANY IMPLIED WARRANTIES, INCLUDING WITHOUT LIMITATION, THE IMPLIED WARRANTIES OF MERCHANTABILITY AND FITNESS FOR A PARTICULAR PURPOSE SHALL BE LIMITED TO THE DURATION OF THIS LIMITED WARRANTY, OTHERWISE THE REPAIR, REPLACEMENT OR REFUND AS PROVIDED UNDER THIS EXPRESS LIMITED WARRANTY IS THE EXCLUSIVE REMEDY OF THE CONSUMER, AND IS PROVIDED IN LIEU OF ALL OTHER WARRANTIES, EXPRESS OR IMPLIED. IN NO EVENT SHALL NICOR BE LIABLE, WHETHER IN CONTRACT OR IN TORT (INCLUDING NEGLIGENCE) FOR DAMAGES IN EXCESS OF THE PURCHASE PRICE OF THE PRODUCT, OR FOR ANY INDIRECT, INCIDENTAL, SPECIAL OR CONSEQUENTIAL DAMAGES OF ANY KIND, OR LOSS OF REVENUE OR PROFITS, LOSS OF BUSINESS OR OTHER FINANCIAL LOSS ARISING OUT OF OR IN CONNECTION WITH THE ABILITY OR INABILITY TO USE THE PRODUCT TO THE FULL EXTENT THESE DAMAGES MAY BE DISCLAIMED BY LAW.

Copyright 2016, NICOR, Inc.
Revised November, 2016

This device complies with part 15 of the FCC Rules. Operation is subject to the following two conditions: (1) This device may not cause harmful interference, and (2) this device must accept any interference received, including interference that may cause undesired operation.

NOTE: This equipment has been tested and found to comply with the limits for a Class A digital device, pursuant to part 15 of the FCC Rules. These limits are designed to provide reasonable protection against harmful interference when the equipment is operated in a commercial environment. This equipment generates, uses, and can radiate radio frequency energy and, if not installed and used in accordance with the instruction manual, may cause harmful interference to radio communications. Operation of this equipment in a residential area is likely to cause harmful interference in which case the user will be required to correct the interference at his own expense.