

NOTICE

* Please make sure that you have all parts indicated and they are in good condition before you begin assembly of this item. Refer to part list and hardware list below for guidance.

* This item should be assembled on the ceiling to prevent scratching the finish during assembly.

* To reduce the risk of fire, electrical shock or injury to persons or property, please follow the guideline below for safe use and installation.

PREPARATION

* Before beginning assembly of product, make sure all parts are present. Compare parts with part contents list and hardware contents list.

* If any part is missing or damaged, do not attempt to assemble the product.

* Estimated Assembly Time: 30 minutes.

* If you are having difficulty, our friendly Customer Care team is always here to help. Please email customersupport@safavieh.com.

CARE AND MAINTENANCE









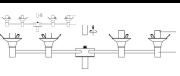

* Unplug lamps before using any cleaning solutions.

* Dust shades with a feather duster or with an appropriate vacuum brush attachment.

* Wipe with a soft, dry cloth and clean lamp bases with the methods appropriate to the material.

* Avoid the use of chemicals and household cleaners as they may damage the finish.

Part List and Hardware List

PEICE	DESCRIPTION	PICTURE	QUANTITY	PEICE	DESCRIPTION	PICTURE	QUANTITY
A	Lamp Body		1X	HW2	Screw $\phi 4*25$		2X
B	Tubes		6X	HW3	M4 Nut		2X
C	Canopy		1X	I	Socket with clip		6X
D	Mounting Plate		2X	J	Shade		6X
HW1	Screw, $\phi 4*25$		2X	K	Light bulb		6X
F	Terminal Cap		2X				

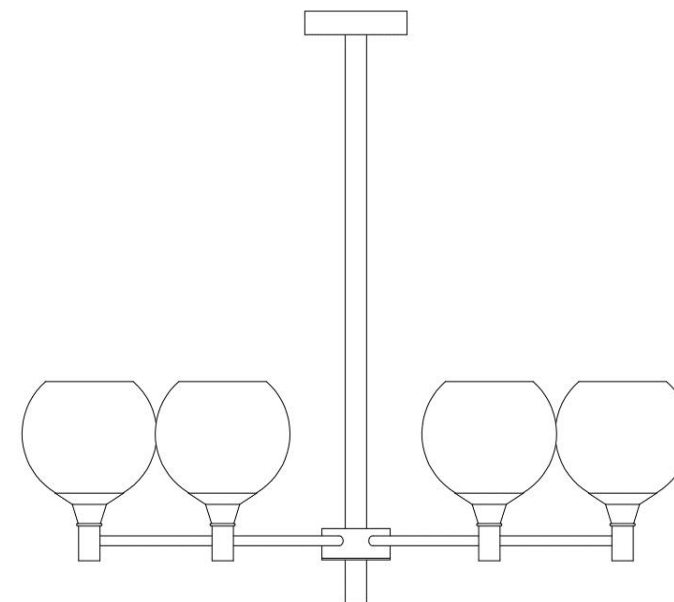

PREPARATION

* Before beginning assembly of product, make sure all parts are present. Compare parts with part contents list and hardware contents list.

* If any part is missing or damaged, do not attempt to assemble the product.

* Estimated Assembly Time: 30 minutes.

* If you are having difficulty, our friendly Customer Care team is always here to help.

NOTE: PLEASE USE TYPE "G45" BULB MAX 40-WATT OR CFL BULB MAX 8-WATT OR LED BULB MAX 4-WATT, THERE IS LED 4-WATT BULB IN THE BOX

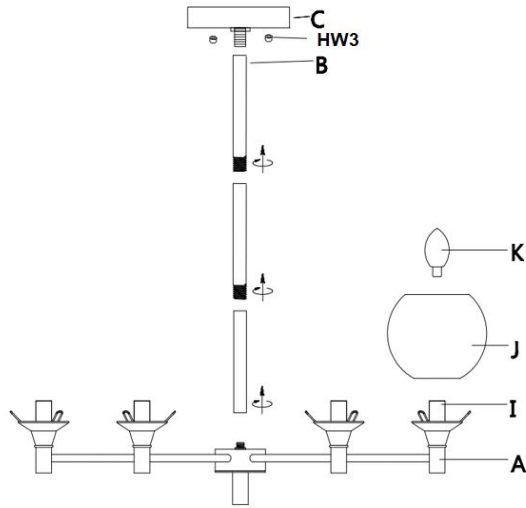

Step 1: Unpack all parts from cartons carefully. Thread tubes (B) into canopy (C) and connect tubes (B) with light body (A)

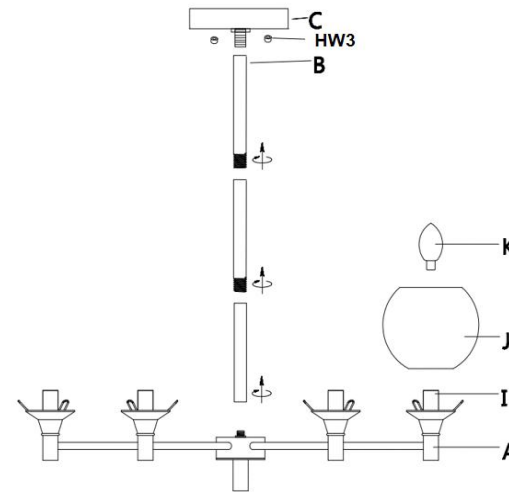

STEP2: I thread all light bulbs (K) into socket (I), and put all glass shades (L) on socket (I) and clip in. PLEASE USE TYPE "G45" BULB MAX 60W OR CFL BULB MAX 13-WATT OR LED BULB MAX 9WATT THERE ARE 6 PCS LED BULB IN THE BOX

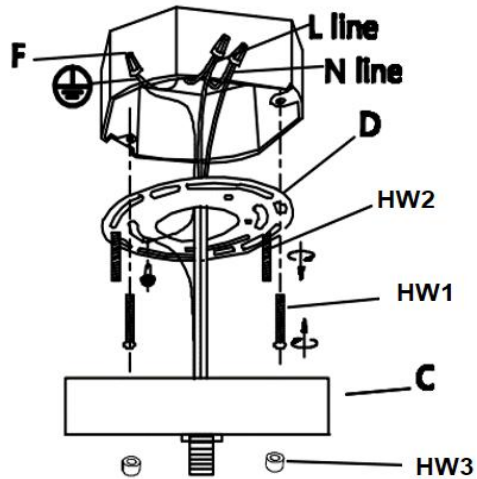

STEP3: To connect fixture wires: Connect the live wire (L) from fitting to the live wire from main power supply. Connect the neutral wire (N) from fitting to the neutral wire from main power supply. Make the Terminal cap (HW2) connect the ground wire. Please pay close attention to avoiding the wires exposing outside when wiring connections.

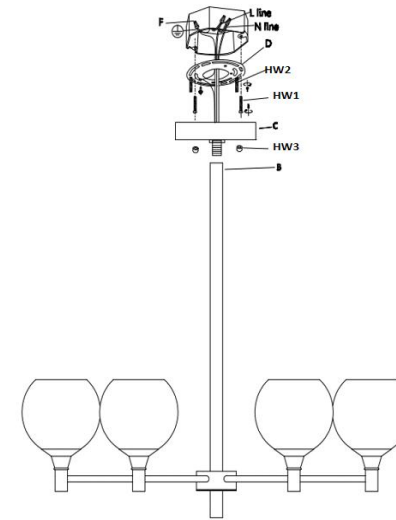

STEP4: I install the mounting plate (D) into the canopy (C), lock them with screw (HW2). Then install the canopy (C) to the junction box with screw (HW1), then fix them with M4 nuts (HW3). Consult a qualified electrician to ensure correct branch circuit conductor