

# ASSEMBLY INSTRUCTIONS



PRODUCT  
INSTRUCTION  
VIDEO

## Belize 72"



# Belize 72"

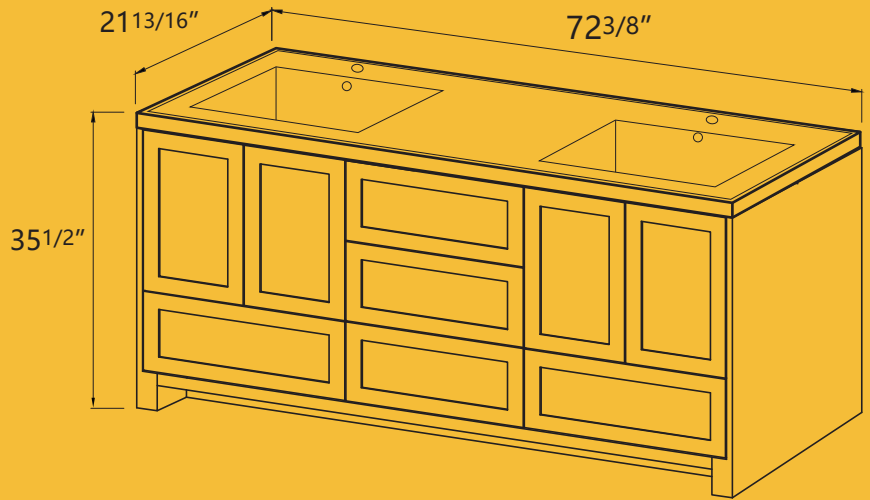

## COUNTERTOP SIZE

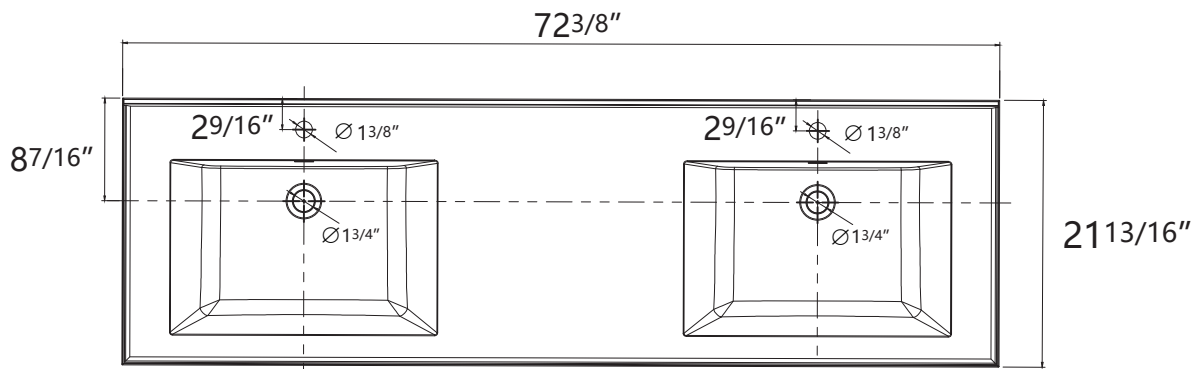

Top View

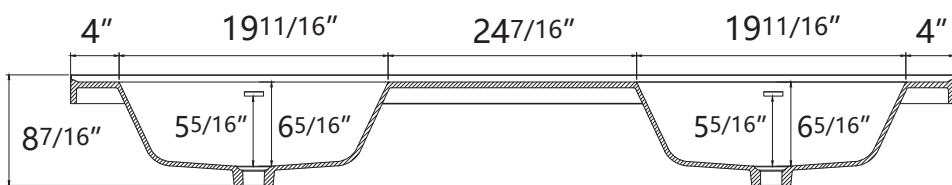

Front View

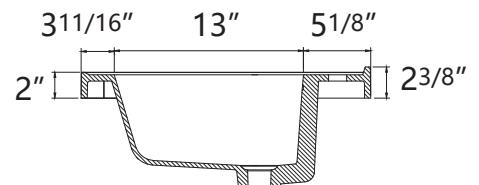

Side View

## VANITY SIZE

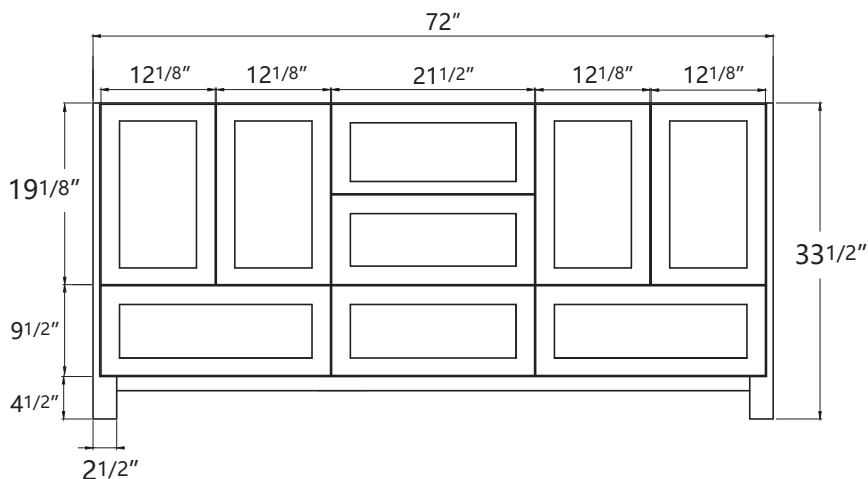

Front View

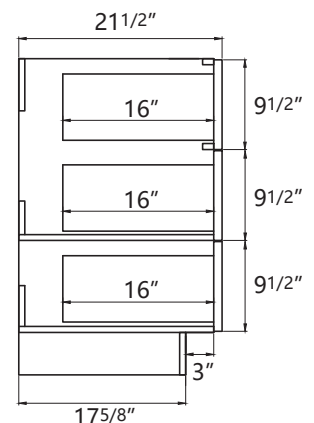

Side View

**Belize 36"**

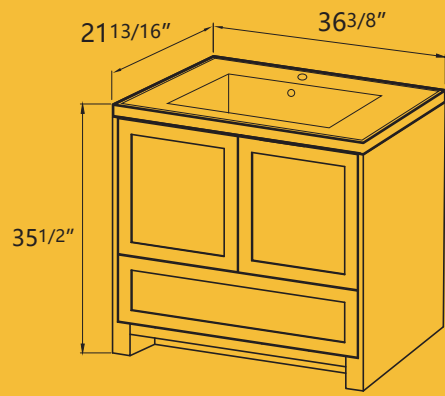

**Belize 42"**

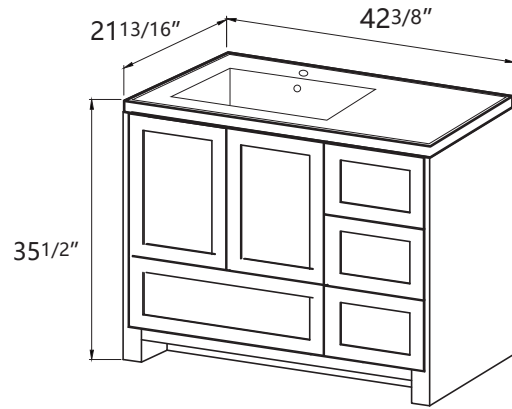

**Belize 48"**

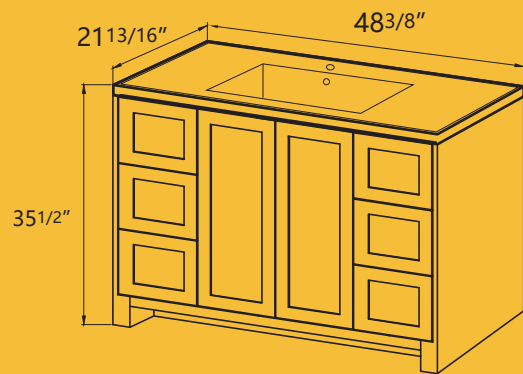

**Belize 60"**

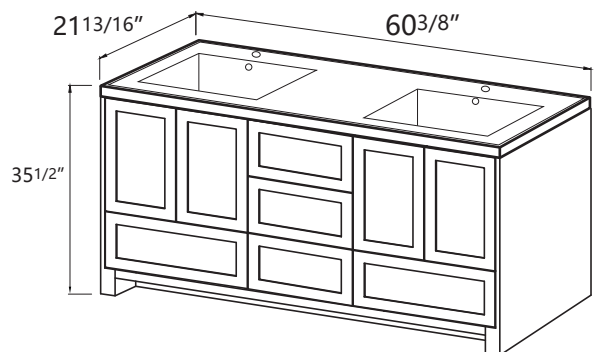

**Belize 72"**

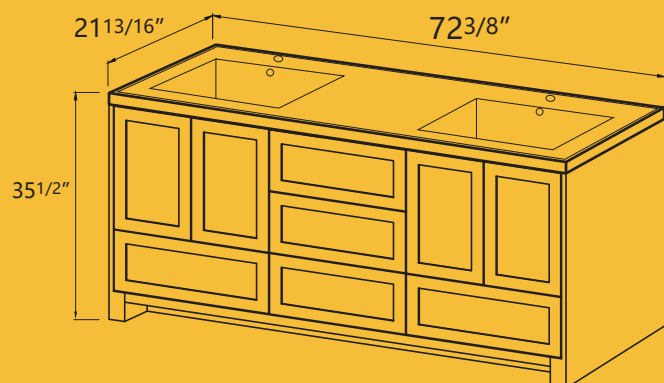

## PRE-ASSEMBLY

Installing a bathroom vanity can vary depending on the specific type and design of the vanity, as well as your bathroom setup. Here are some general steps to guide you through the process:

1. **Prepare the area:** Clear out the space where the vanity will be installed. Ensure the plumbing lines are in place and ready for connection.
2. **Measure the space:** Measure the dimensions of the vanity and the available space in your bathroom to ensure it will fit properly.
3. **Turn off the water supply:** Before starting any work, be sure to turn off the water supply to the bathroom.
4. **Remove the old vanity:** If there is an existing vanity, you will need to disconnect the plumbing, remove the sink, and take out the old vanity.



**NOTE:** A drain pipe and trap are not included with this vanity.

## TOOLS REQUIRED



Safety goggles

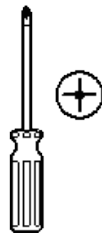

Philips screwdriver



Level

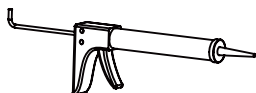

Silicone



Clean rag



**NOTE:** Any size of the vanity's installation steps are the same.

## INSTALLATION STEPS

**1. Prepare the Vanity:** Make sure the vanity is in place and securely attached to the wall.

**2. Seal the Edges:** To prevent water damage and ensure a clean finish, apply a bead of silicone caulk along the edges where the countertop meets the vanity.

(For Example)

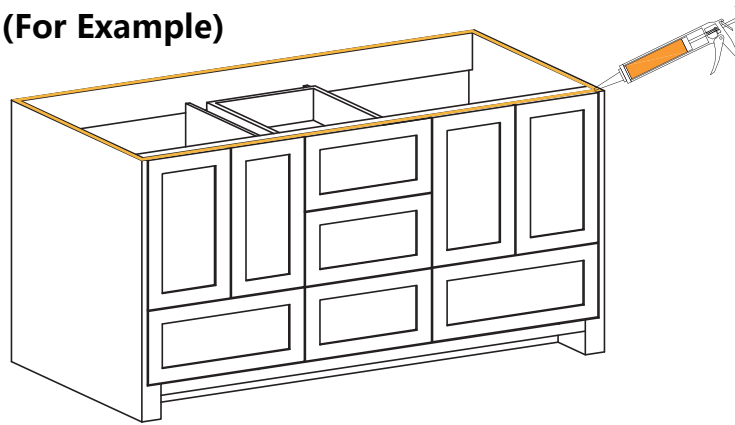

**3. Attach the Countertop:** Secure the solid surface countertop on the vanity.

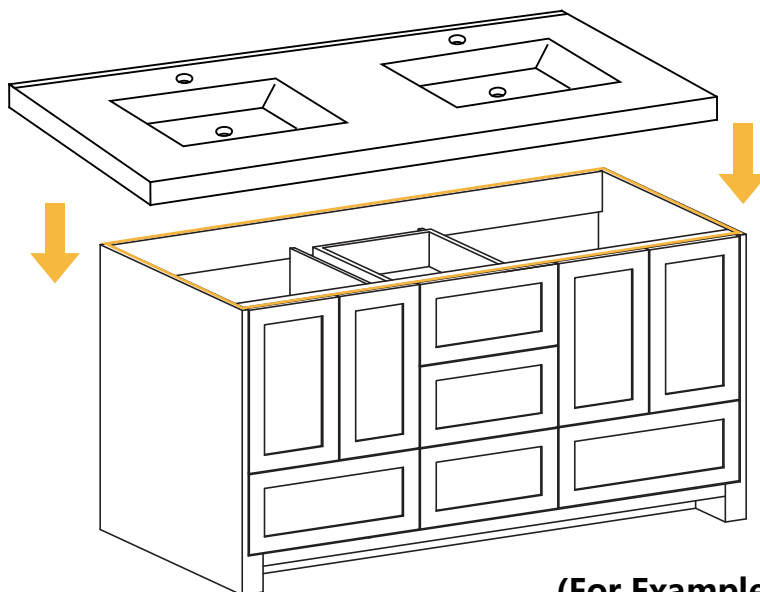

(For Example)

**4.Position the Countertop:** Carefully place the countertop on top of the vanity, ensuring it is centered and aligned correctly.

**5.Connect Plumbing Fixtures:** Once the countertop is securely in place, reconnect the plumbing fixtures such as the faucet, drain, and any other accessories on the countertop.

**6.Test for Leaks:** Turn on the water supply and check for any leaks around the plumbing connections. Adjust as needed to ensure a watertight seal.

**7.Finish Up:** Clean any excess caulk and ensure that the countertop is clean and ready for use.

**8.Install the handle:** loosen the screw of the handle which pre-installed inside the vanity, and take it out, according to the same location to install the handle on the opposite side of the cabinet surface.

(For Example)

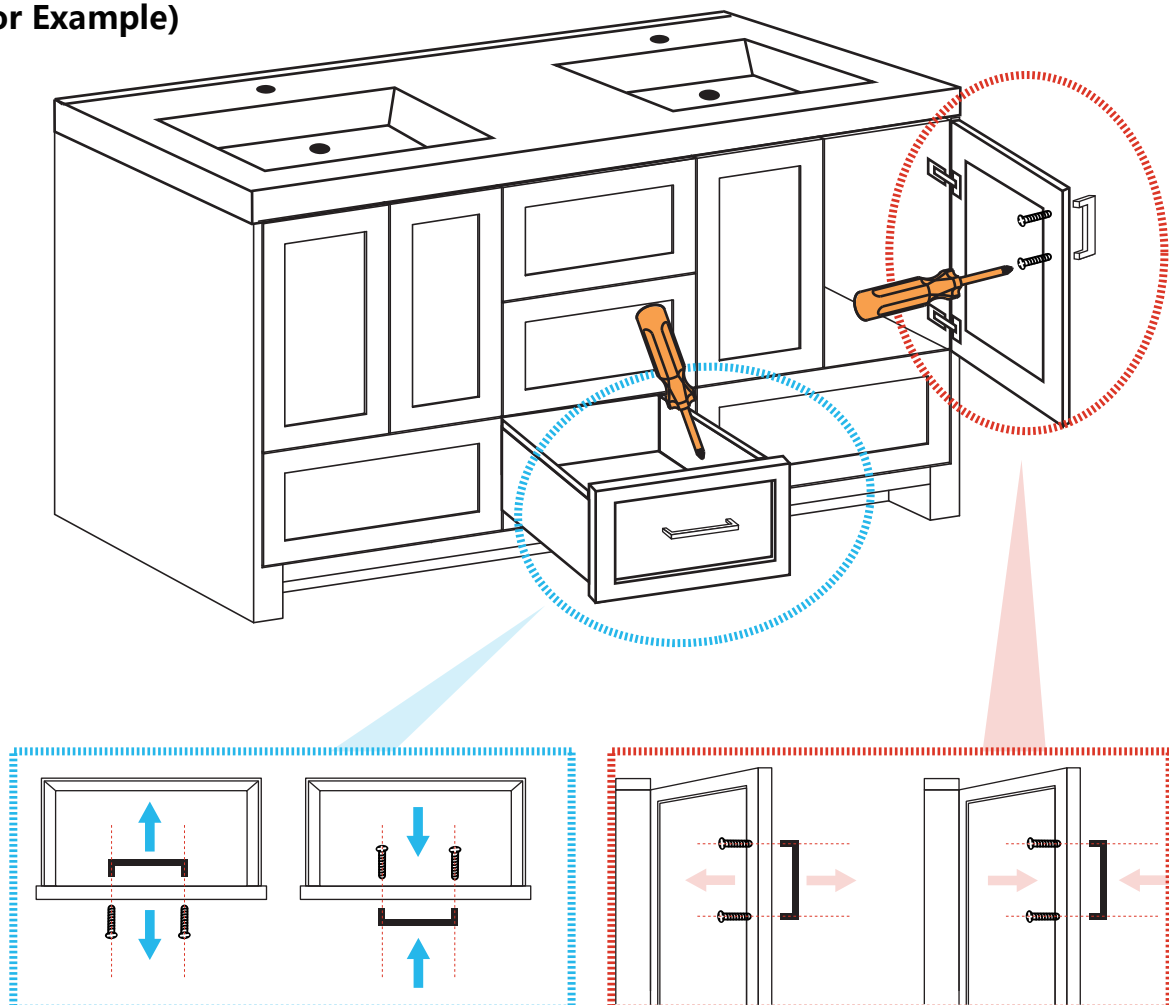

## CARE & MAINTAINCE

**1.Regular Cleaning:** Wipe down the vanity regularly with a soft cloth and a mild, non-abrasive cleaner to remove dust, dirt, and grime. Avoid using harsh chemicals or abrasive cleaners that could damage the finish.

**2.Prevent Water Damage:** Keep the vanity dry by wiping up any spills or splashes immediately. Avoid leaving wet items on the vanity surface for extended periods.

**3.Use Coasters and Trivets:** Place coasters under toiletries, cosmetics, and hot hair styling tools to prevent damage from heat or moisture.

**4.Check for Leaks:** Regularly inspect the plumbing connections under the vanity for any leaks. Address any leaks promptly to prevent water damage to the vanity.

**5.Avoid Harsh Cleaners:** Refrain from using abrasive cleaners, ammonia-based products, or harsh chemicals on the vanity surface, as they can damage the finish.

**6.Protect the Surface:** Consider using a protective sealer or wax specially formulated for your vanity material to maintain its finish and protect it from water damage.

**7.Adjust Hinges and Hardware:** Periodically check and tighten loose hinges, knobs, or drawer pulls to ensure smooth operation and prevent damage.

**8.Remove Stains Promptly:** If you notice any stains on the vanity surface, try to clean them promptly using a gentle cleanser recommended for your vanity material.

**By following these maintenance tips, you can help preserve the aesthetics and functionality of your bathroom vanity for years to come.**

# HOME SERVICES



INSTALLATION VIDEO

## Missing Part or Defective?

Please Contact the Customer Service Team

✉ [service@getprohome.com](mailto:service@getprohome.com)

☎ 626 679 3588