

Manual Book

Crystal Chandelier



Safety Rules

WARNING: BE SURE THE ELECTRICITY TO THE WIRES YOU ARE WORKING ON IS SHUT OFF; EITHER THE FUSE IS REMOVED OR THE CIRCUIT BREAKER IS TURNED OFF. TURNING THE POWER OFF USING THE LIGHT SWITCH IS NOT SUFFICIENT TO PREVENT ELECTRICAL SHOCK.

NOTE: The important safeguards and instructions appearing in this manual are not meant to cover all possible conditions or situations that may occur. It must be understood that common sense, caution, and care, are factors which cannot be built into any product. These factors must be supplied by the person(s) installing this unit.

READ & SAVE THESE INSTRUCTIONS

CAUTION: Before assembling the lighting fixture, refer to the section titled Wiring Connections. If you feel you do not have enough electrical wiring experience, either refer to a do-it-yourself wiring handbook or have your lighting fixture installed by a qualified, licensed electrician.

UNPACK THE PACKAGE

Check the contents to be sure everything is included

Tools Needed: Slotted screwdriver, Adjustable wrench, Step ladder, Wire cutters, wiring supplies as required by electrical code.

INSTALLATION & OPERATION INSTRUCTIONS GENERAL

Before starting the installation, disconnect the power by turning off the circuit breaker or by removing the appropriate fuse at the fuse box. Turning the power off using the light switch is not sufficient to prevent electrical shock.

All electrical connections must be in accordance with local and National Electrical Code (NEC) standards. If you are unfamiliar with proper electrical wiring connections, obtain the services of a qualified electrician.

Remove the fixture and the mounting packages from the box and make sure that no parts are missing by referencing the illustrations on the installation instructions.

Be sure to read these installation instructions and review the diagrams thoroughly before installation.

LIGHT BULBS REQUIRED

This fixture uses E12 bulb base, works with incandescent, LED, CFL, halogen or color changing bulbs up to 40W. Fully dimmable when used with dimmable bulbs and a compatible dimmer switch (not included).

BULBS ARE NOT INCLUDED IN THIS ITEM. Please purchase the right bulbs you need.

1. Installation Preparation

Tools You Need



Ladder

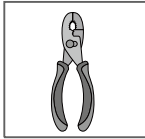

Pliers

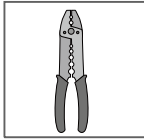

Wire Strippers

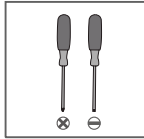

Screwdrivers

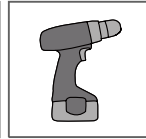

Power Drill (optional)



Drill Bit (optional)

If mounting to a support structure, you will also need the optional tools.

2. Mounting & Wiring

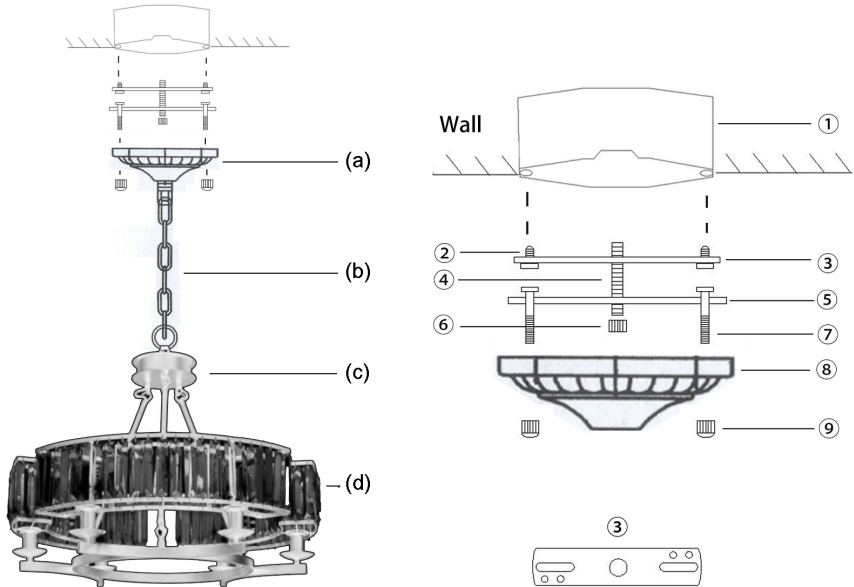

NOTE: Please test the fixture before installation to ensure it is working properly.

1. Turn off power at circuit box to avoid possible electric shock.
2. Attach outlet box bracket ③ to your outlet box ① with screws ② from the box.
3. Attach fixture bracket ⑤ to the outlet box bracket ③ with threaded tube ④ and nut ⑥ provided.
4. Assemble the shade (see next page), adjust the wire and chain length to get a proper height, attach the chain and fixture to the canopy (a).
5. Pass fixture wires through the chain and canopy ⑧. Connect black/brown fixture wire to your live wire, white/blue wire to neutral wire, yellow & green wire to your ground wire (optional).
6. Attach the canopy and fixture assembly to the fixture bracket ⑤ with screws ⑦ and cap nut ⑨ provided.
7. Install the light bulb (E12 Max. 40W each, LED recommended).

NOTE:

1. Outlet box ① and machine screw ② are not included in this item.
2. This item can also be installed as a ceiling light fixture, no need the chain and canopy (a). You can open the top cover of the middle canopy (c), then install (C) as (a) as the same steps above.

3. Fixture Assembly

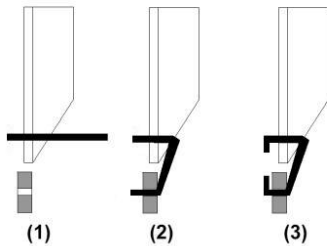
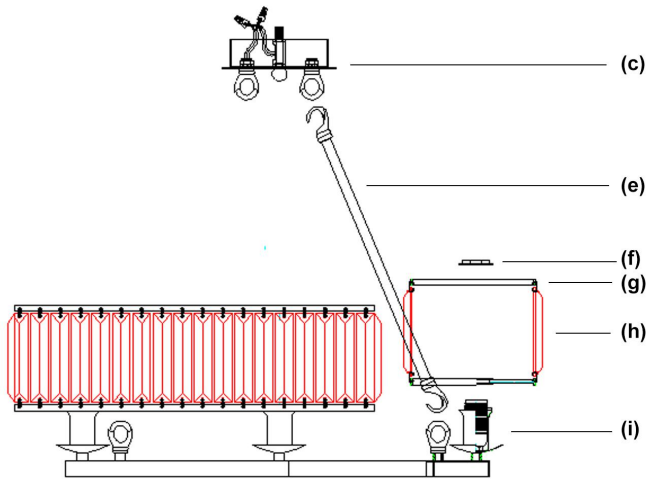

Packing List
Canopy & Fixture: 1 set
Moon-shaped Frame: 3 pcs
Crystal: 138 pcs + spares
Clip: 276 pcs + spares

Fig 1

Light shade assembly:

1. Attach crystal pieces (h) onto the metal frame (g) as figure 1.
2. Attach the frame assembly (g) onto the bulb holder (i) with cover (f).
3. Attach the fixture to the middle canopy (c) with hook rod (e).

Trouble Shooting

1. Missing/Broken Parts

- Make a list of the missing/broken parts according to the packing list, take photos for broken parts, then email us for free replacements.

2. Bulbs Do Not Light Up

- Check your power and switch to make sure it's power on.
- Check the bulb to make sure it's installed correctly.
- Change a new bulb.
- Check the wires to make sure they are connected correctly.

3. Bulbs Flicker/Noisy Operation

- Check the bulb to make sure it's installed correctly.
- Change a new bulb.
- Make sure your bulb is dimmable if you use a dimmer switch.

4. Could Not Install/Assemble

- Take photos of the ceiling/fixture, contact seller for technical support.

Clean And Care

To clean, wipe fixture with soft cloth. Spray from chemical cleaners can discolor the finish of fixture. Do not use scouring pads, powders, steel wool or abrasive paper to clean this fixture.

Ordering Parts

Keep this manual for future reference, and in case replacement parts are needed. Available parts can be ordered from place of purchase. Use exact wording from diagrams when ordering parts.