

**INSTRUCTION**

---

# 7 Pcs Sofa Set

**Assembly & Care instructions**

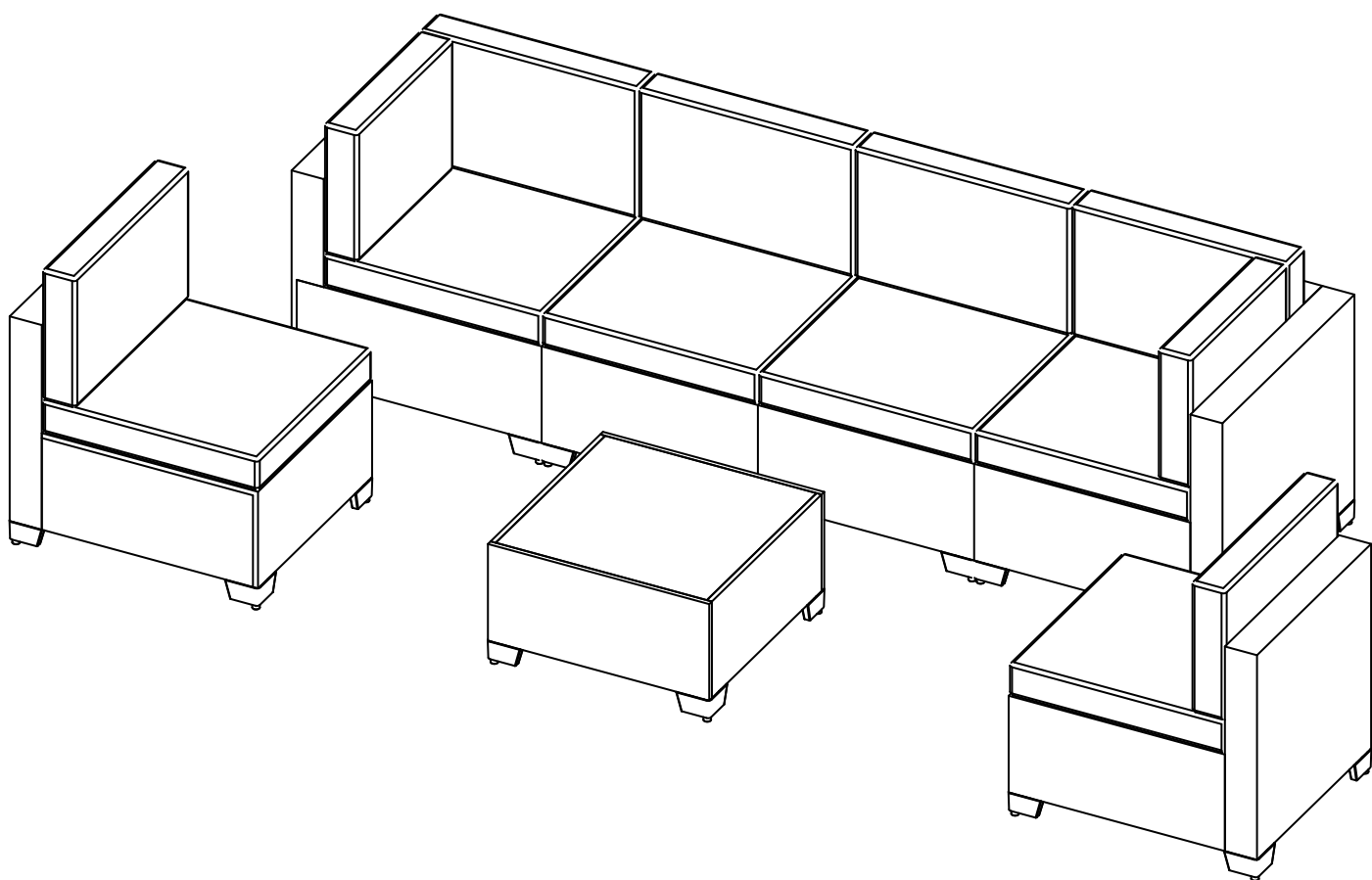

**SKU: P25001-S1**

Please read & retain for future reference

## CATALOGS

IMPORTANT .....	3
Care & Instructions .....	4
How to Cover Holes & Repair Broken Wicker.....	4
Packing List of Box A .....	7
Screw set A .....	8
Packing List of Box B .....	9
Screw set B.....	10
Packing List of Box C.....	11
Screw set C .....	12
Installation Instructions of Corner Sofa .....	13
Installation Instructions of Middle Sofa .....	15
Installation Instructions of Coffee Table .....	16
Installation Instructions of U-Shaped Connector.....	20
Installation Instructions of Replacement .....	21

## IMPORTANT

This 7 pcs sofa's corner sofas are completely identical.  
Just rotate it 90 degrees to fit the combination.

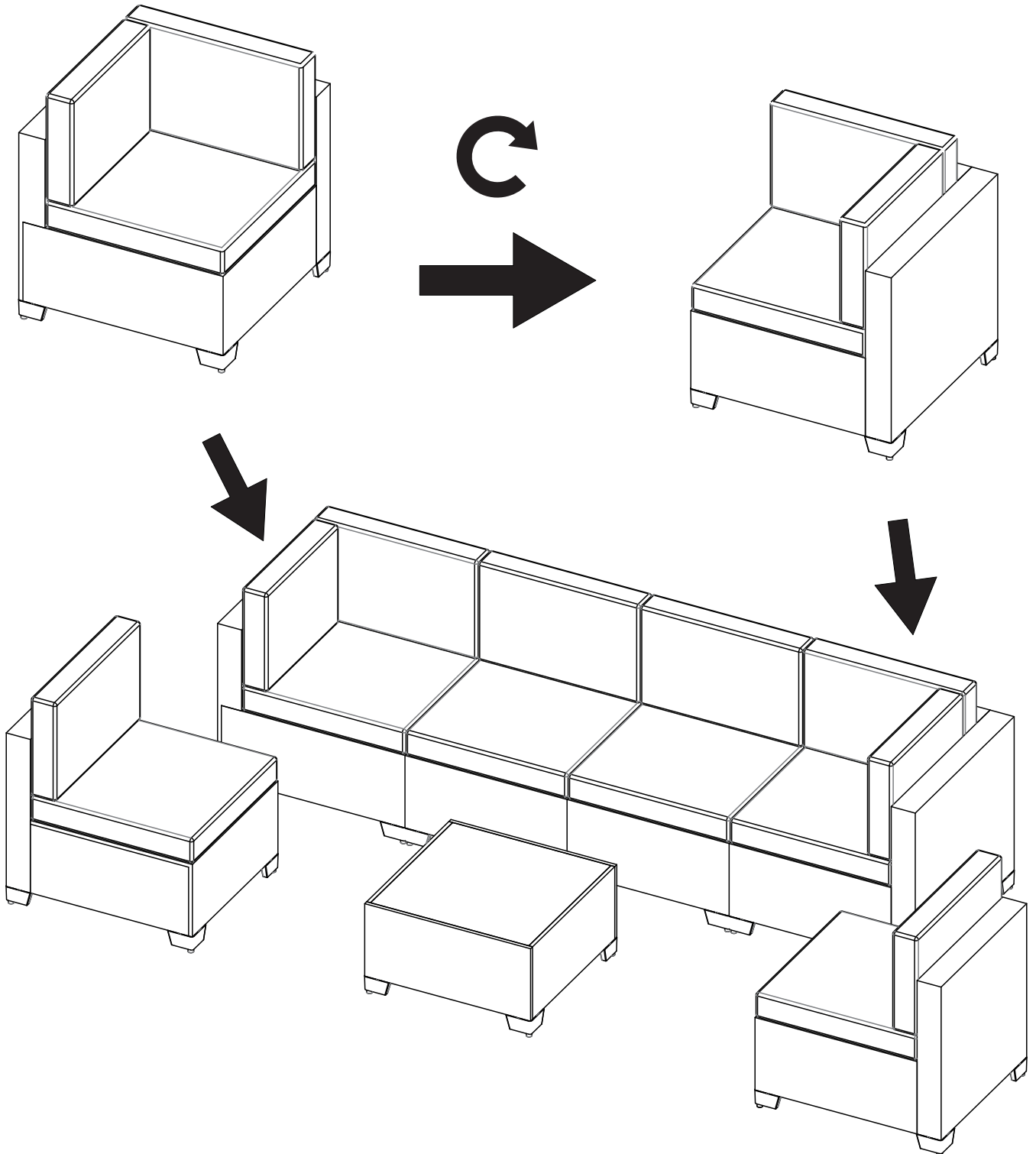

## Care & Instructions

Thank you for ordering the 7 pcs sofa set, here are some tips which may help you:

1. This 7 pcs sofa set comes in 3 boxes. If you only receive 1 box or 2 boxes, please do not worry. The others will arrive very soon.
2. Carton A contains 2 middle sofas plus 1 coffee table; Carton B contains 2 middle sofas; Carton C contains 2 corner sofas (The corner sofas are completely identical).
3. Amazon only allows us to upload 1 tracking number. If you want to know the others' tracking numbers, please contact us.
4. If any part is damaged or missing (please refer to packing list on page 5~10), please feel free to contact us. We will send you the replacement immediately.
5. In order to prolong the sofa set's service life, we suggest that you put all the cushions indoors on a rainy day.
6. We hope you can enjoy our product, if you have any other problem, please feel free to contact us.

Contact US:

Service@alaulm.com  
www.alaulm.com

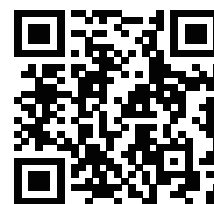

## How to Cover Holes & Repair Broken Wicker



Step 1



Step 2









Step 3

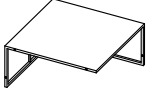
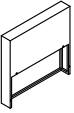

Step 4

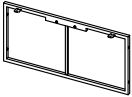
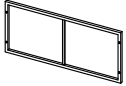

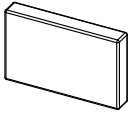
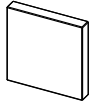
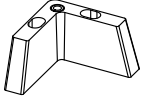













You can use two pieces PE wicker to cover the hole, and repeat the steps to cover all the holes. These PE wicker can also be used to repair the scratch or broken wicker.

## Packing List of Box A

Box	Img	Part Name	Label No.	Qty
Box A		Middle Sofa Seat Part	L001	2
		Middle Sofa Back Part	L002	2
		Middle Sofa Side Part	L003	2
		Coffee Table Short Side Part	L004	2
		Coffee Table Long Side Part	L005	2
		Coffee Table Glass Top	L006	1
		Coffee Table Connector	L007	1
		Long Back Cushion With Core Inside	L011	2
		Seat Cushion With Core Inside	L013	2
		High L-Shaped Feet	L017	12
		U-Shaped Connector	L018	4
	—	Instructions	—	1
	—	Screw Set	SSA	1

# SCREW SET

## Screw set A





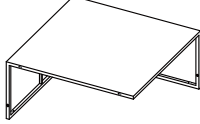
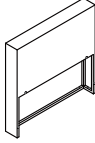
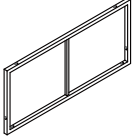
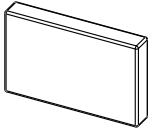
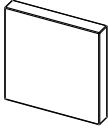
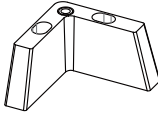
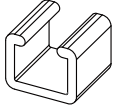



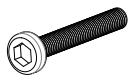

Product Name	Label No.	Img	Part Name	Qty
Middle Sofa's Screw	A		Bolt M6×30	6
	B		Bolt M6×45	24
	C		Washer Nut	8
	D		Adjustable Screws	8
	F		Spanner	2
	G		Wrench	2
Coffee Table's Screw	A		Bolt M6×30	12
	B		Bolt M6×45	8
	D		Adjustable Screws	4
	E		Glass Mat	5
	F		Allen Wrench	1
Additional Screws-A	A		Bolt M6×30	2
	B		Bolt M6×45	4
	C		Washer Nut	2
	D		Adjustable Screws	1
	H		Restoration of rattan	1
	I		velcro	1

## Packing List of Box B

Box	Img	Part Name	Label No.	Qty
Box B		Middle Sofa Seat Part	L001	2
		Middle Sofa Back Part	L002	2
		Middle Sofa Side Part	L003	2
		Long Back Cushion With Core Inside	L011	2
		Seat Cushion With Core Inside	L013	2
		High L-Shaped Feet	L017	8
		U-Shaped Connector	L018	4
	—	Instructions	—	1
	—	Screw Set	SSB	1

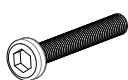
# SCREW SET

## Screw set B

Product Name	Label No.	Img	Part Name	Qty
Middle Sofa's Screw	A		Bolt M6×30	6
	B		Bolt M6×45	24
	C		Washer Nut	8
	D		Adjustable Screws	8
	F		Spanner	2
	G		Wrench	2
	Additional Screws-B	A		Bolt M6×30
B			Bolt M6×45	2
C			Washer Nut	2
D			Adjustable Screws	1
H			Restoration of rattan	1
I			velcro	1





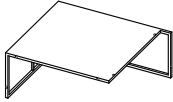
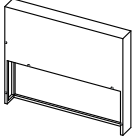
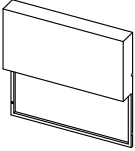
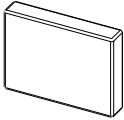
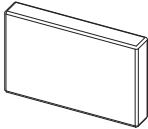
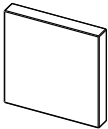
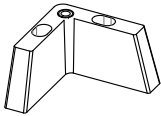
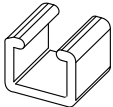





# Parts List

## Packing List of Box C

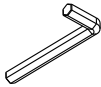
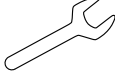
Box	Img	Part Name	Label No.	Qty
Box C		Corner Sofa Seat Part	L014	2
		Corner Sofa Long Back Part	L015	2
		Corner Sofa Short Back Part	L016	2
		Long Back Cushion With Core Inside	L011	2
		Short Back Cushion With Core Inside	L012	2
		Seat Cushion With Cover	L013	2
		High L-Shaped Feet	L017	10
		U-Shaped Connector	L018	4
	—	Instructions	—	1
	—	Screw Set	SSC	1

# SCREW SET

## Screw set C

Product Name	Label No.	Img	Part Name	Qty
Corner Sofa's Screw	A		Bolt M6x30	2
	B		Bolt M6x45	30
	C		Washer Nut	14
	D		Adjustable Screws	8
	F		Spanner	2
	G		Wrench	2
Additional Screws-C	A		Bolt M6x30	2
	B		Bolt M6x45	4
	C		Washer Nut	2
	D		Adjustable Screws	1
	H		Restoration of rattan	1
	I		velcro	1

## Corner Sofa

 Do not use machine  
  Two Persons together  
  Need 25mins roughly

### STEP 1

Assemble Long Back Part(L002) and Seat Part(L001).  
**Tips: Do not tighten 100%.**

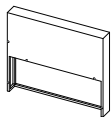
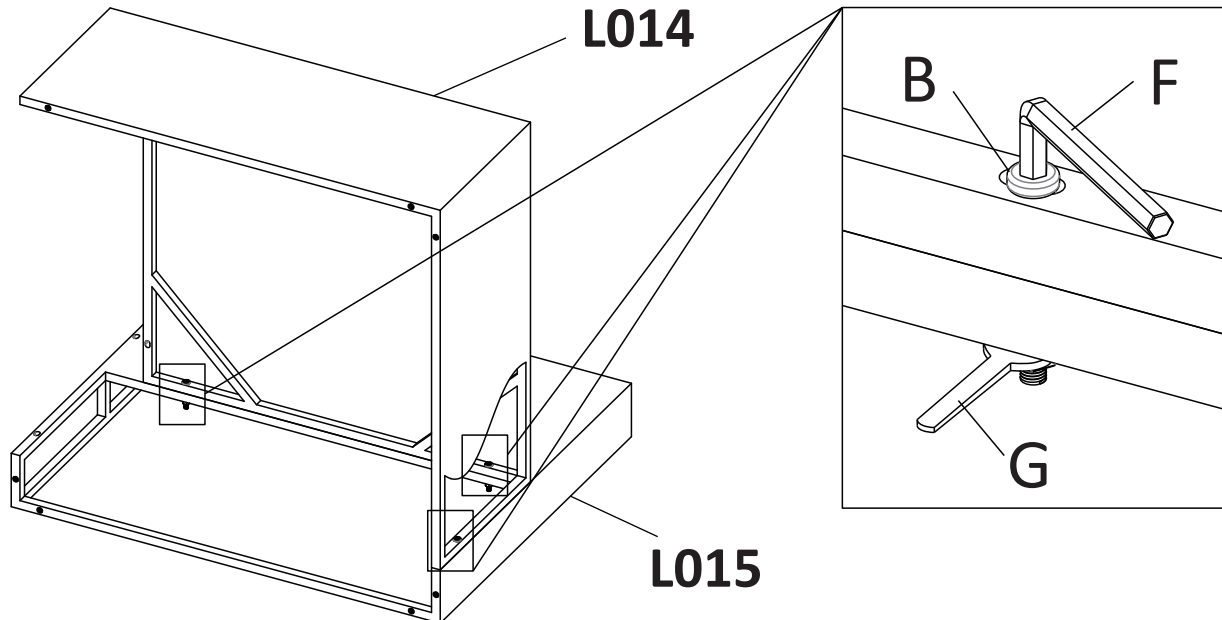

L015 x 1

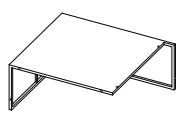

L014 x 1

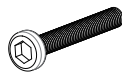

M6x45(B) x 3



Washer Nut(C) x 3

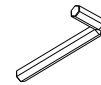

Spanner(F) x 1



Wrench(G) x 1

### STEP 2

Assemble Short Back Part(L003).  
**Tips:Screws 100% Tight This Step.**

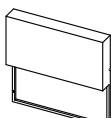
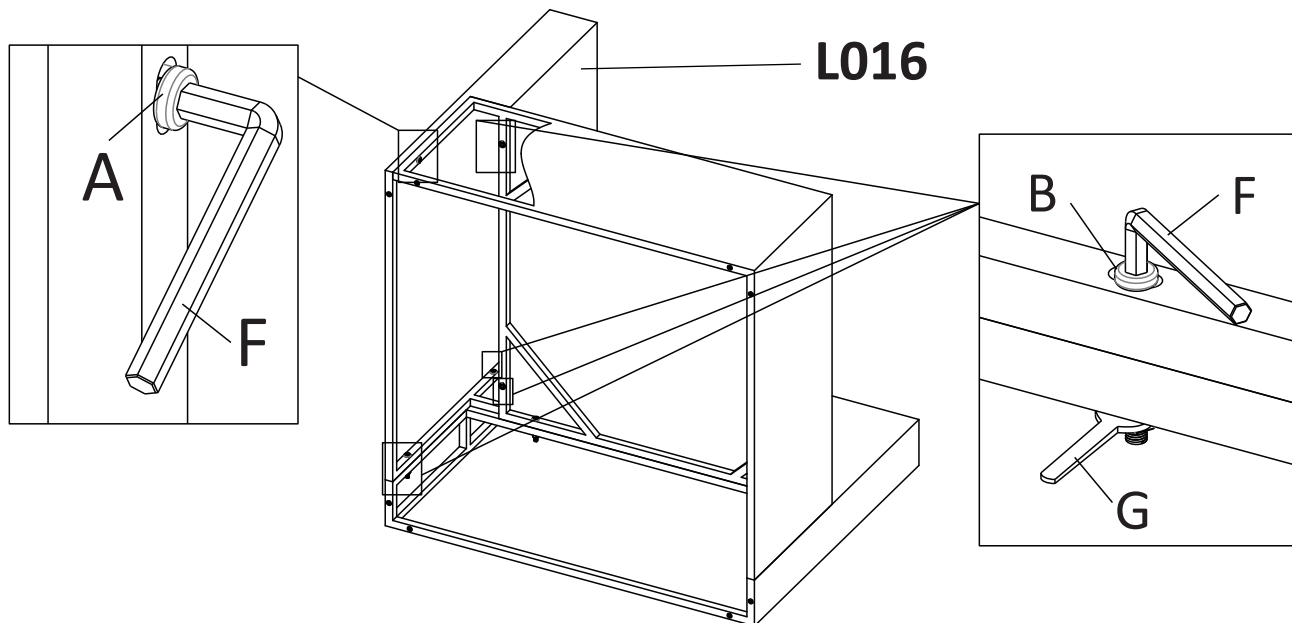

L016 x 1



M6x45(B) x 4



Washer Nut(D) x 4



M6x30(A) x 1



Wrench(G) x 1

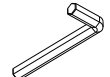

Spanner(F) x 1

## Corner Sofa

 Do not use machine  
 Two Persons together  
 Need 25mins roughly

### STEP 3

Step 3: Assemble High L-Shaped Feet And Screw Feet.

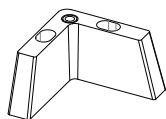
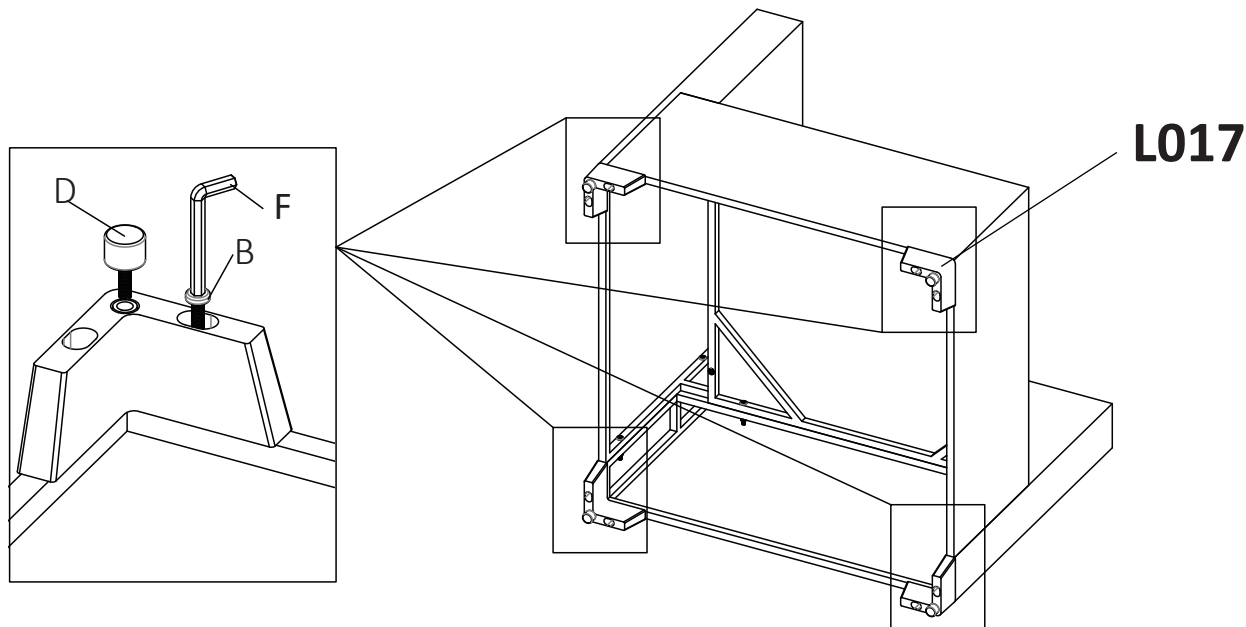

L017 x 4



Screw Feet(D) x 4



M6x45(B) x 8

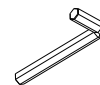

Spanner(F) x 1

### STEP 4

Put the Seat Cushion and Back Cushion on.

Tips: The cushions can be fixed on the back of the sofa with ties.

If you don't need the ties, you can cut them of.

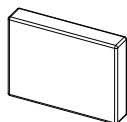
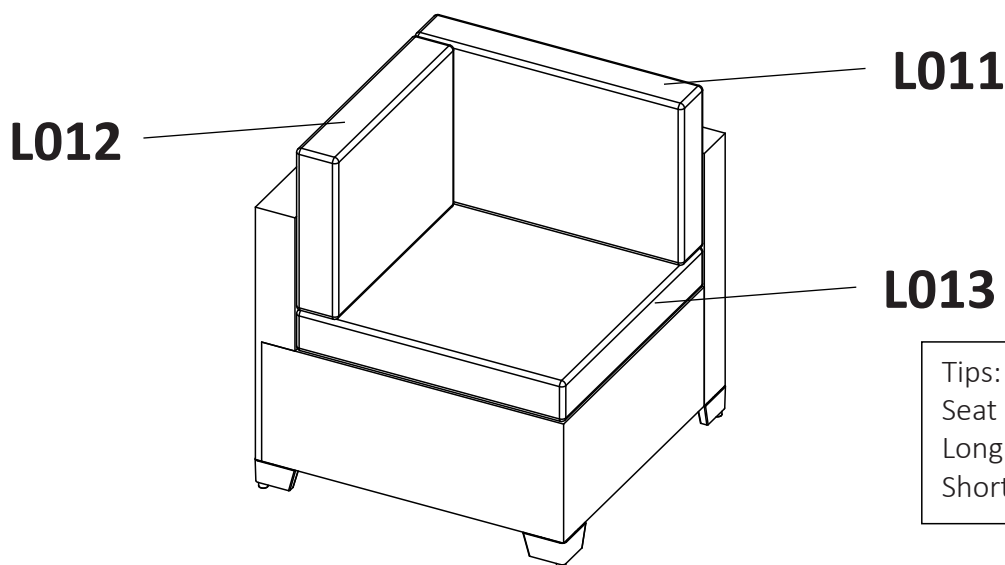

L012 x 1

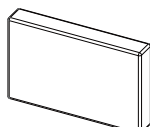

L011 x 1

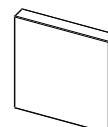

Seat Cushion x 1

## Middle Sofa

 Do not use machine 
  Two Persons together 
  Need 25mins roughly

### STEP 1

Assemble Back Part(L002) And Seat Part(L001).  
**Tips:Do not tighten 100%.**

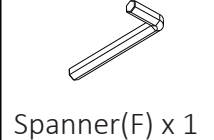
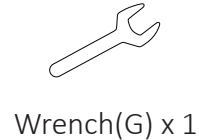
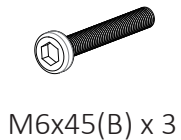
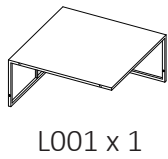
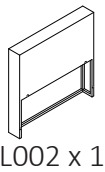
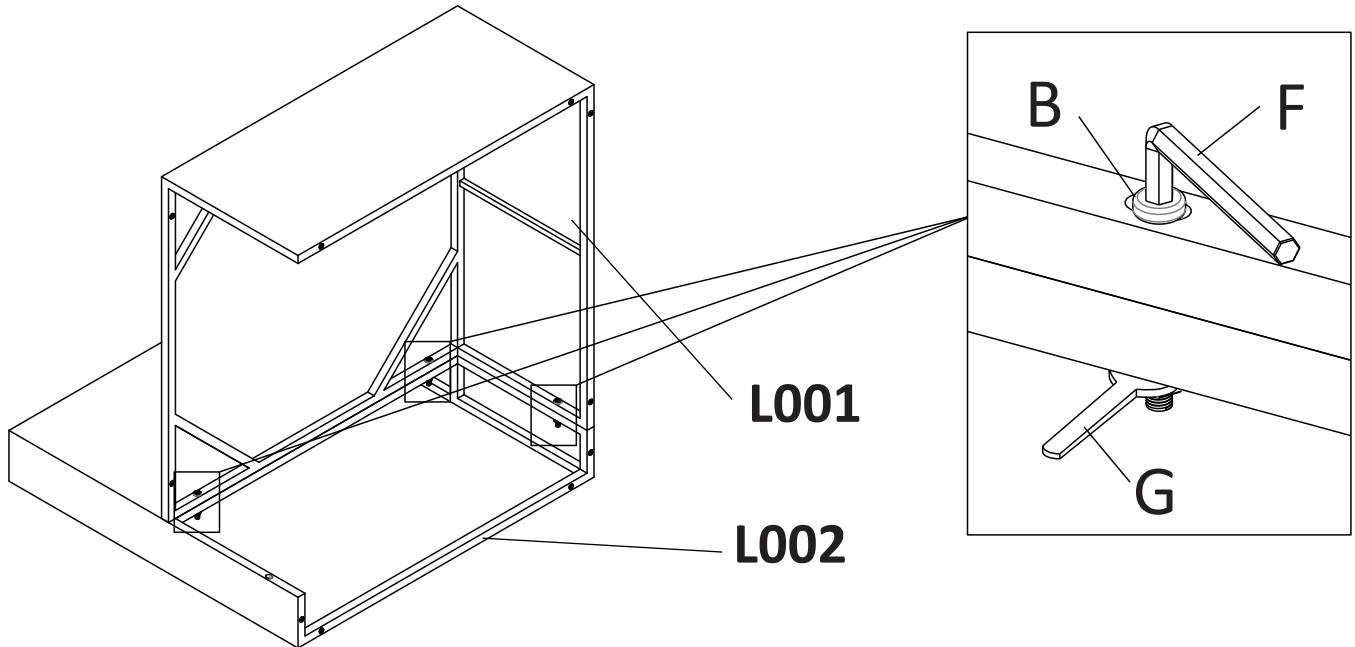

### STEP 2

Assemble Side Part(MSD).  
**Tips:Screws 100% Tight This Step.**

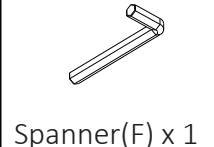
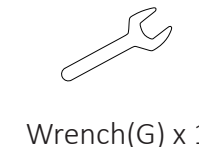
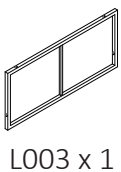
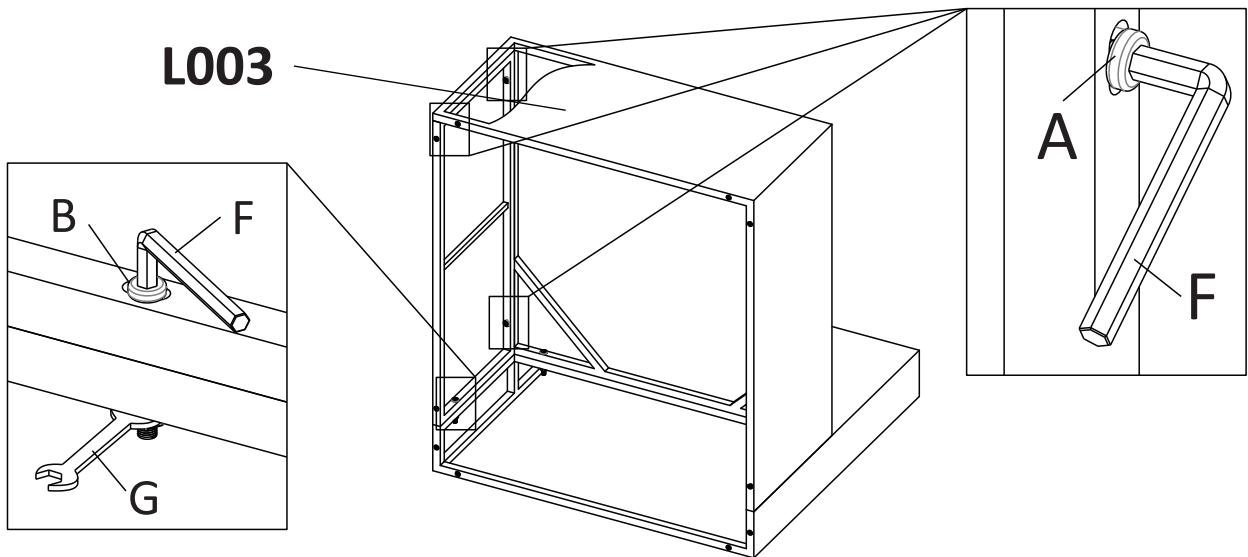

## Middle Sofa



Do not use machine Two Persons together Need 25mins roughly

### STEP 3

Assemble High L-Shaped Feet And Screw Feet.

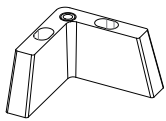
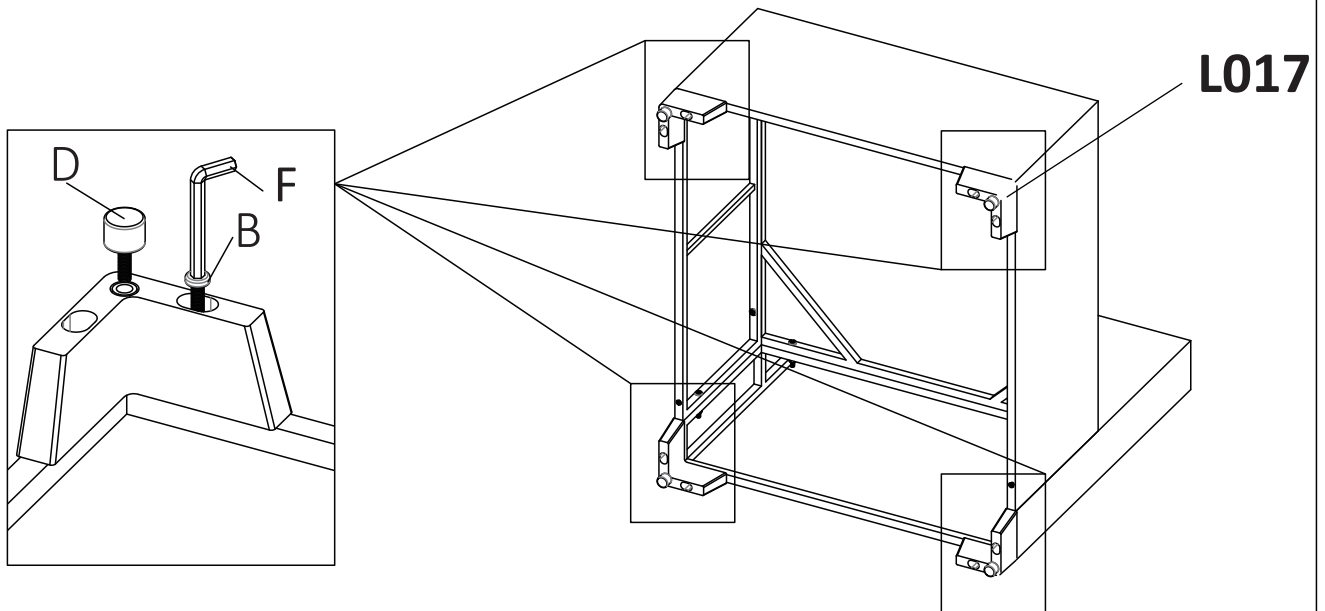

L017 x 4



Screw Feet(D) x 4

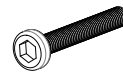

M6x45(B) x 8

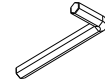

Spanner(F) x 1

### STEP 4

Put the Seat Cushion and Back Cushion on.

Tips: The cushions can be fixed on the back of the sofa with ties.  
If you don't need the ties, you can cut them of.

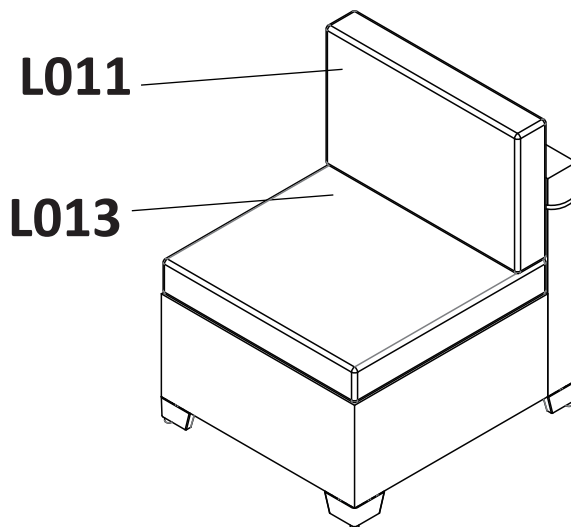

Tips:  
Seat Cushion x 1  
Long Back Cushion x 1  
Short Back Cushion x 1

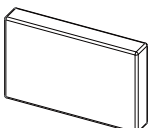

L011 x 1

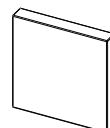

L013 x 1

## Coffee Table



Do not use machine Two Persons together Need 25mins roughly

### STEP 1

Assemble Coffee Table Short Side Part(L004) and Coffee Table Long Side Part(L005). **Tips: Do not tighten 100%.**

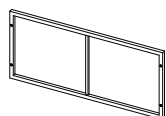
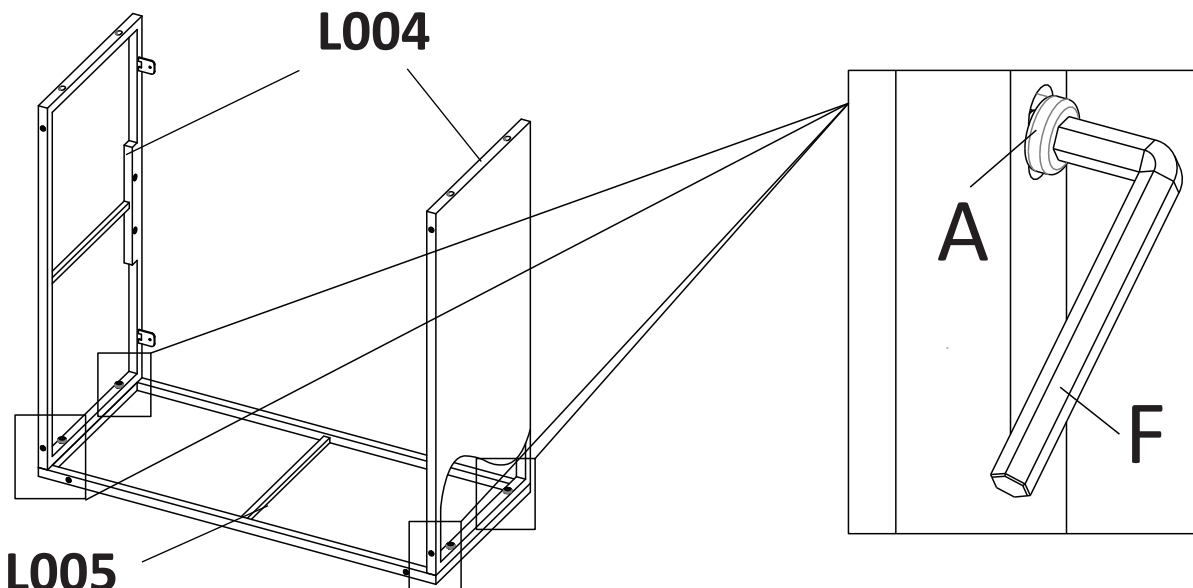

L005 x 1

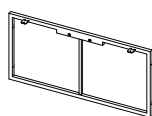

L004 x 2



M6x30(A) x 4



Spanner(F) x 1

### STEP 2

Assemble CTC **Tips: Do not tighten 100%.**

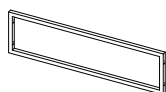
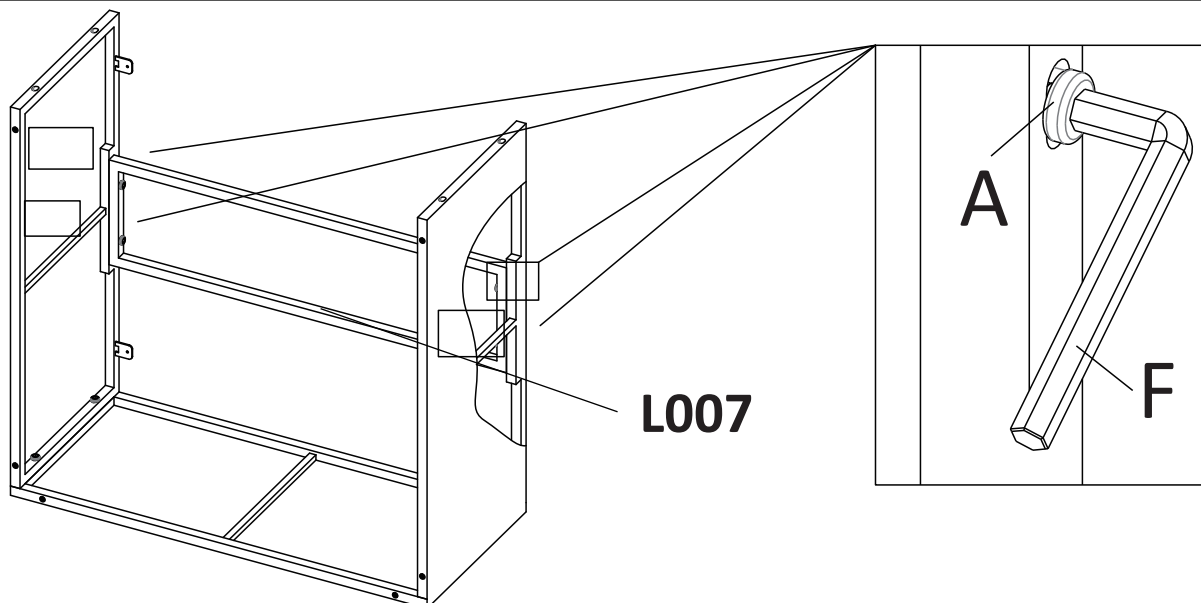

L007 x 1



M6x30(A) x 4



Spanner(F) x 1

## Coffee Table



Do not use machine Two Persons Together Need 25mins roughly

### STEP 3

Assemble Coffee Table Long Side Part(L005).  
**Tips:Screws 100% Tight This Step.**

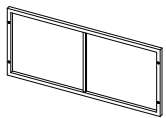
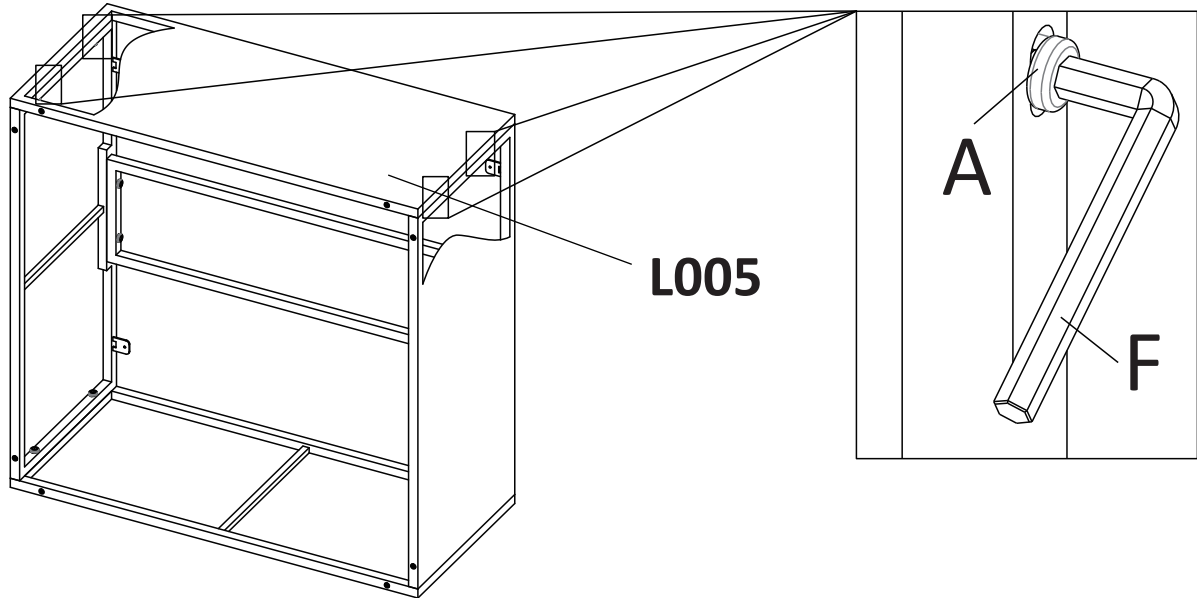

L005 x 1



M6x30(A) x 4

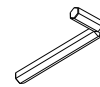

Spanner(F) x 1

### STEP 4

Assemble High L-Shaped Feet.

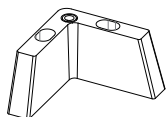
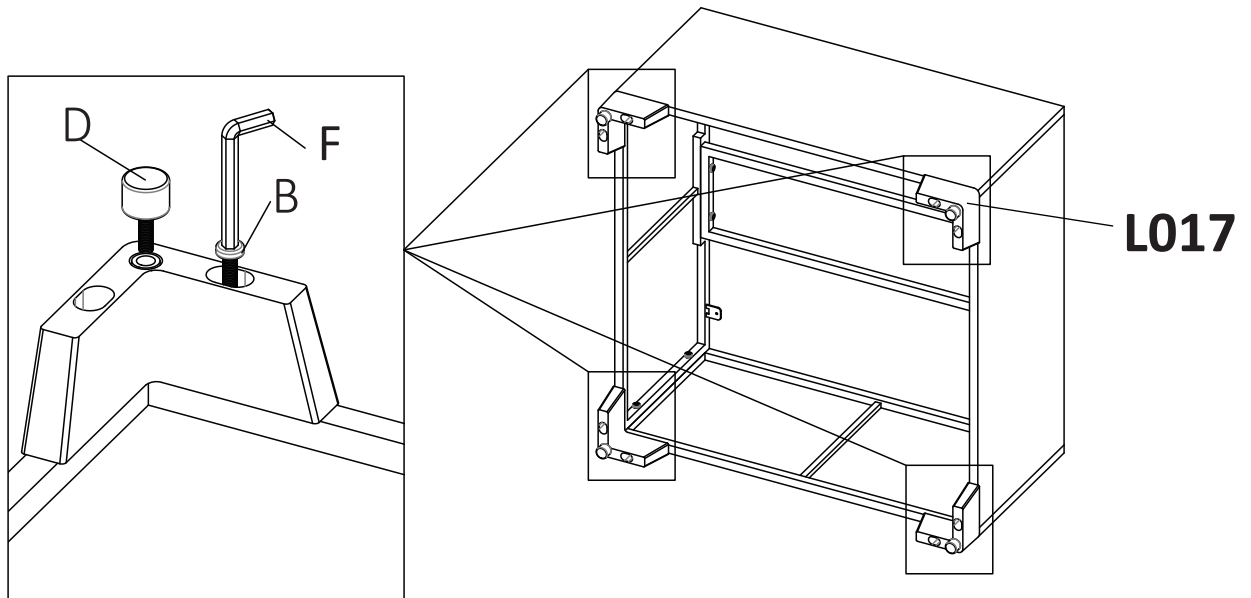

L017x 4

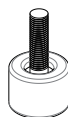

Screw Feet(D) x 4

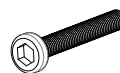

M6x45(B)x 8

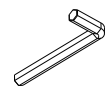

Spanner(F) x 1

## Coffee Table



Do not use machine



Two Persons together



Need 25mins roughly

### STEP 5

Step 5: Press in the Glass Pads(E).

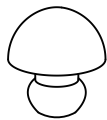
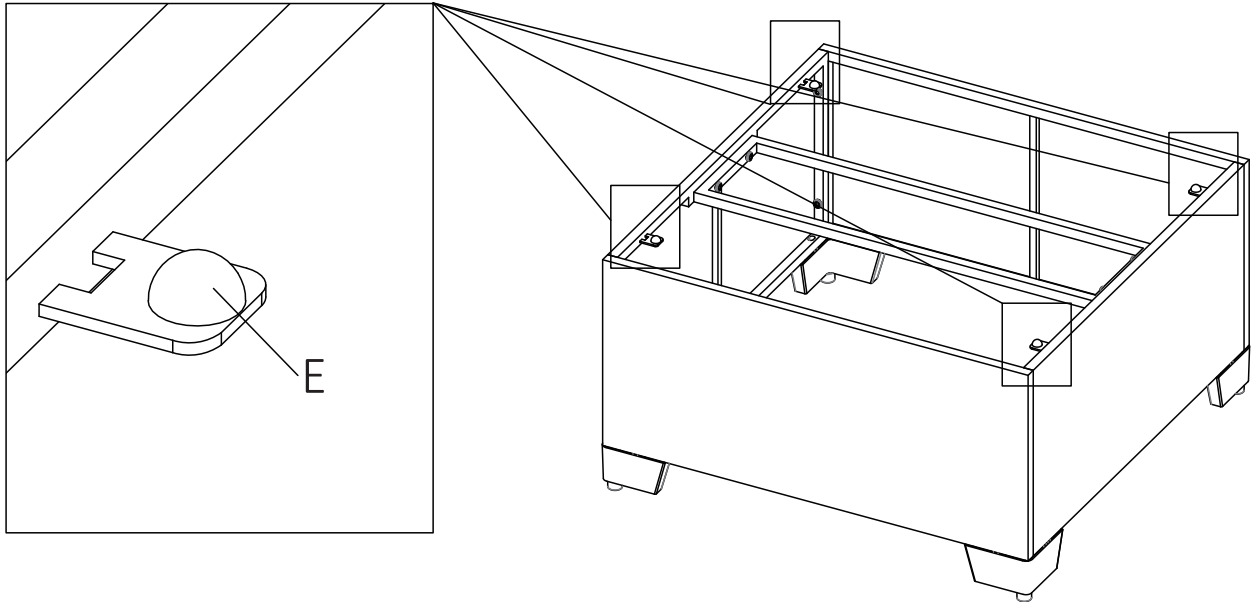

E x 4

### STEP 6

Put on the Glass Top(L006).

L006

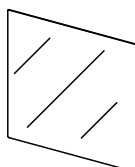
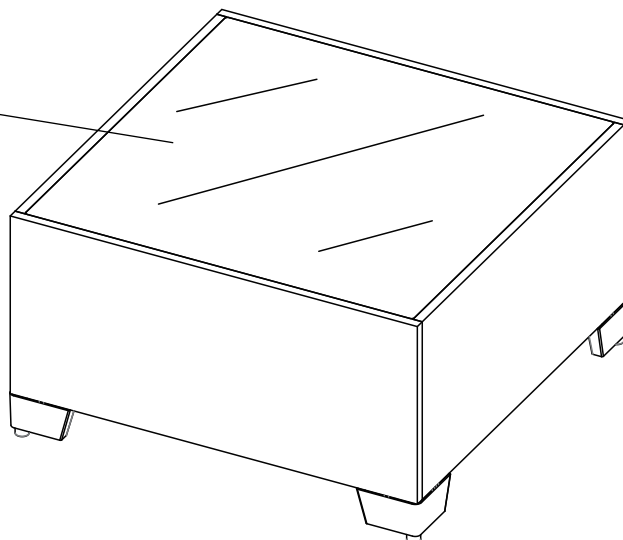

Glass Top(L006) x 1

# U-Shaped Connector

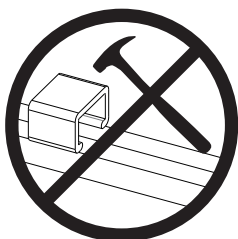
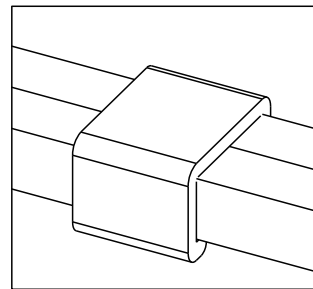
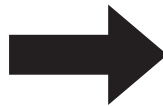
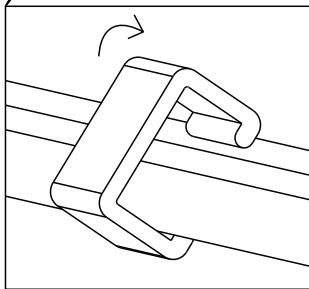
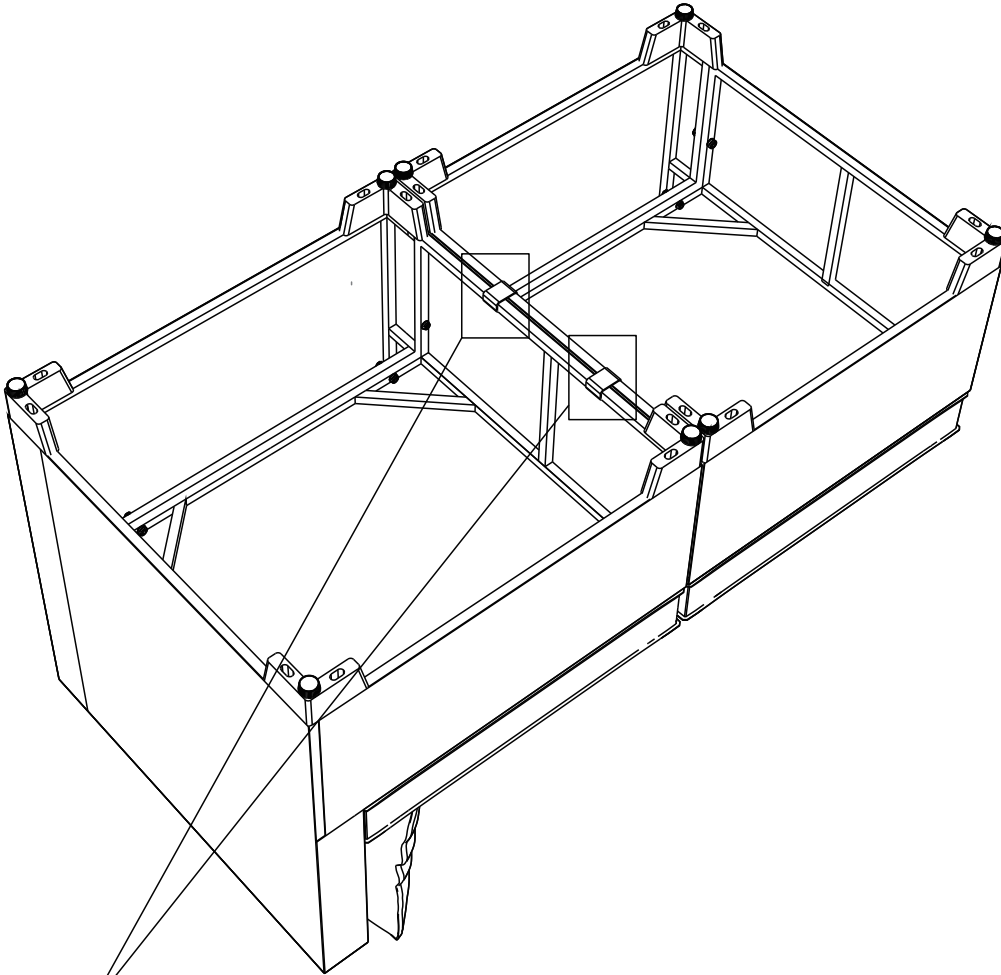

Notice:  
Do not use tools such as hammers;  
You can scald it with hot water to soften it.

## Accessory Replacement



Do not use machine Two Persons together Need 25mins roughly

step 1: Tuck the prickly the out of the seam at the botiom of the sofa. Pull out the prickly the from the surface of the sofa to spread out and adjust to the right position.

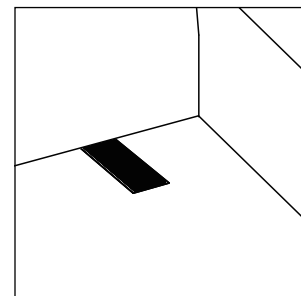
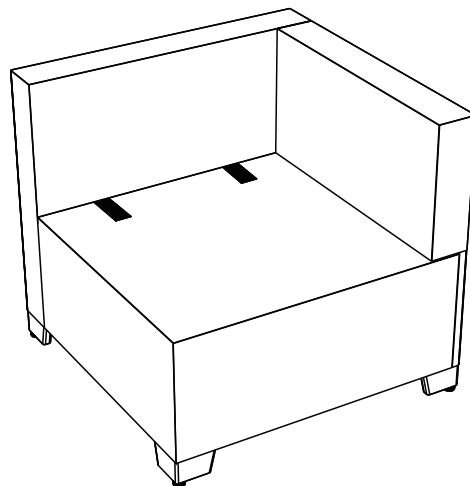
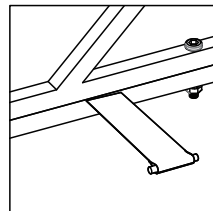
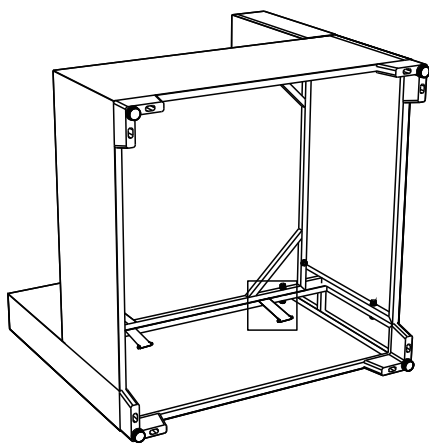

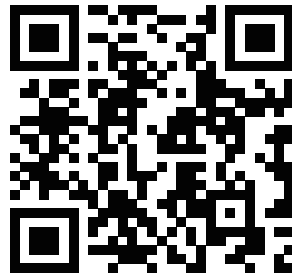

**[www.alaulm.com](http://www.alaulm.com)**

Make Your Life Much Better.