

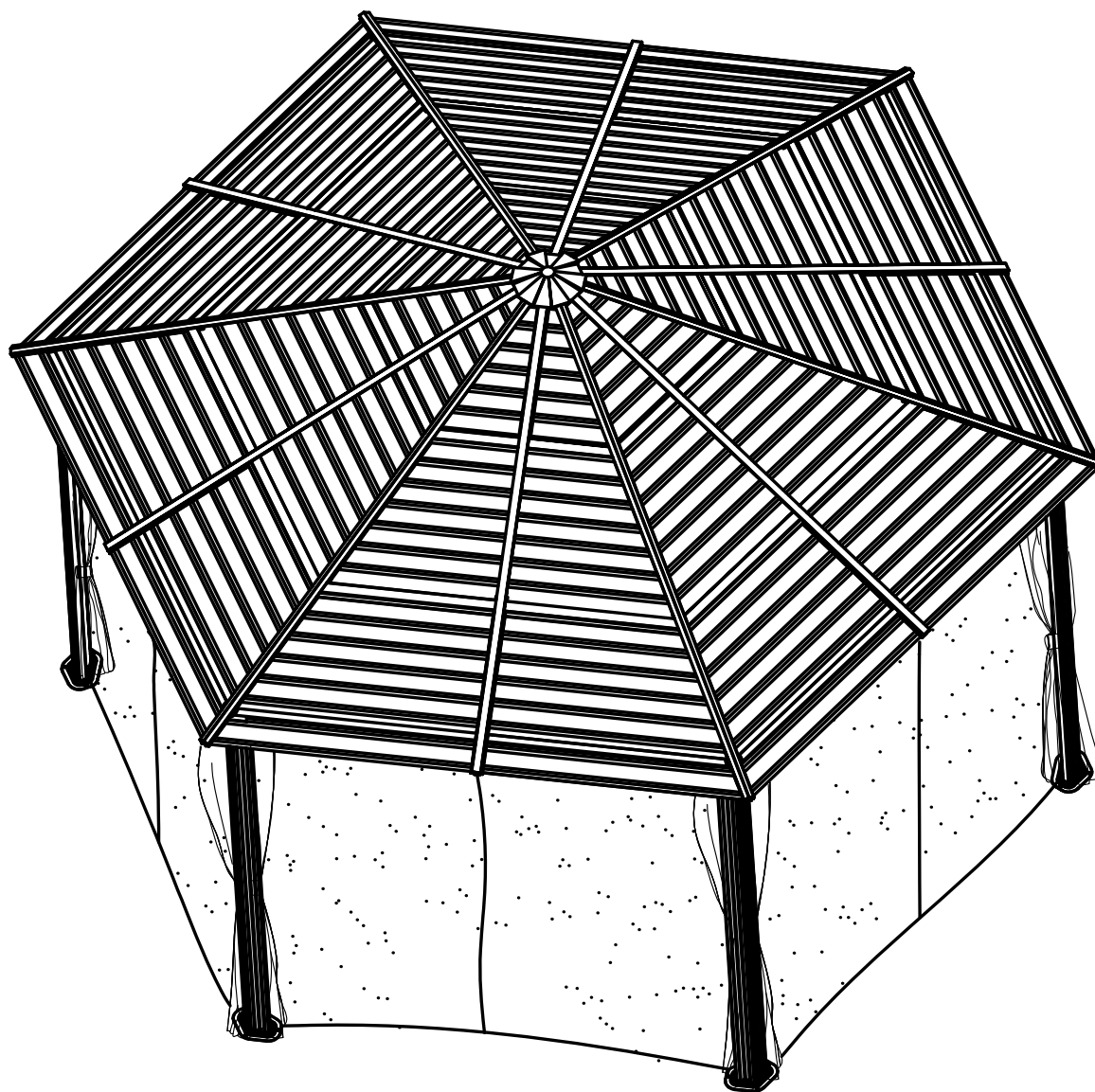















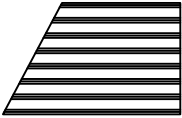





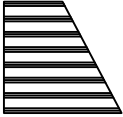



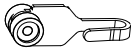



INSTRUCTION MANUAL



LJG003-1313

A		6	N1		6
B		6			
D		6	N2		6
E		6			
G1		6	N3		6
G2		6			
H		6	N4		6
H1		6			
H2		6	N5		6
H3		6			
J1		6	N6		6
K		1			
K1		1	Q		72
L		6	X	 M6*10	48
M1		6	X1	 M6*15	120
M2		6	X2	 5*10	18
M3		18	X3	 5*16	36
M4		6	Z		1
M7		1	Z1		1

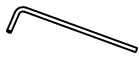

12

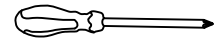

1



12



1

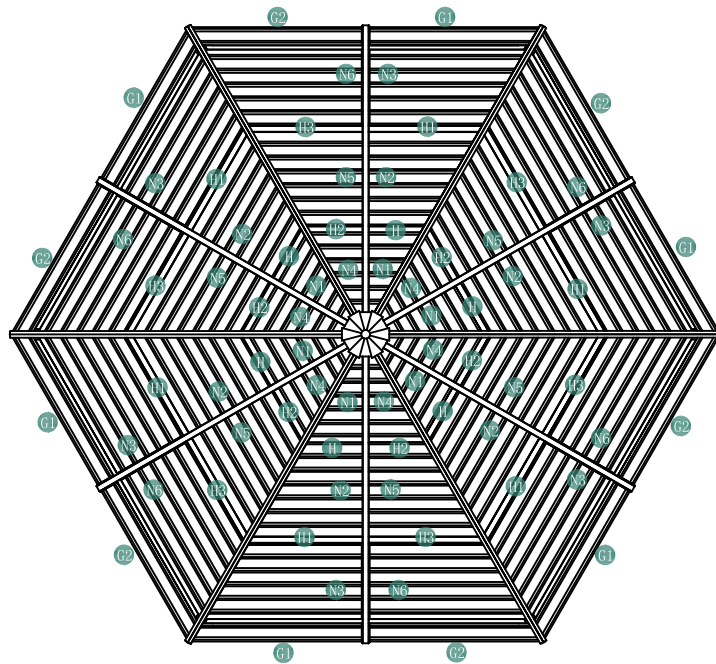
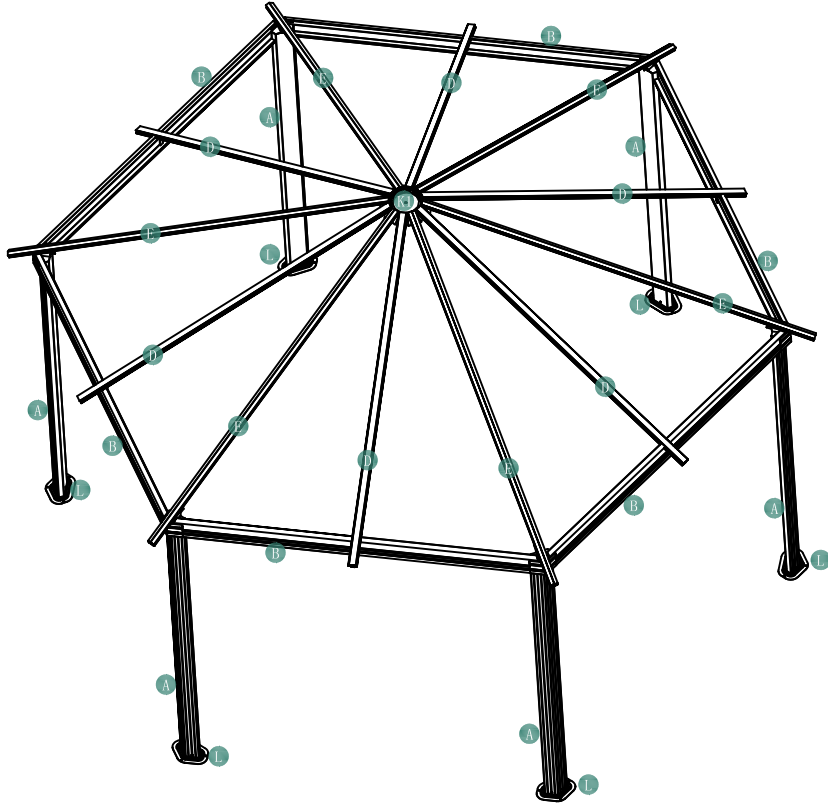

step1

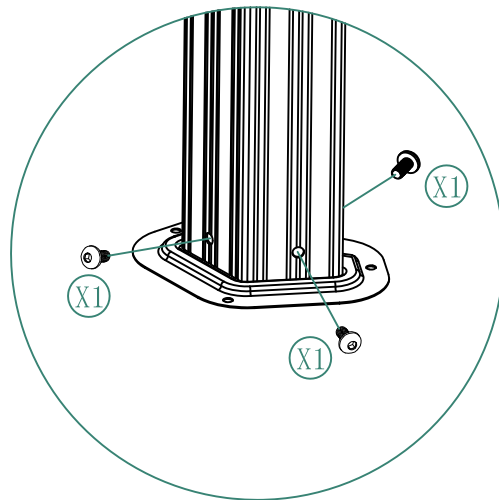
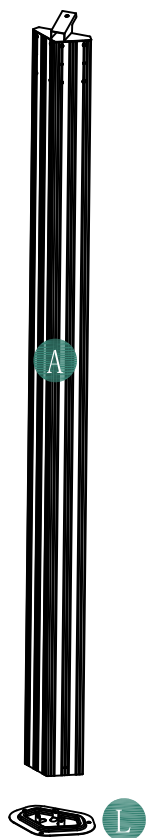

step2

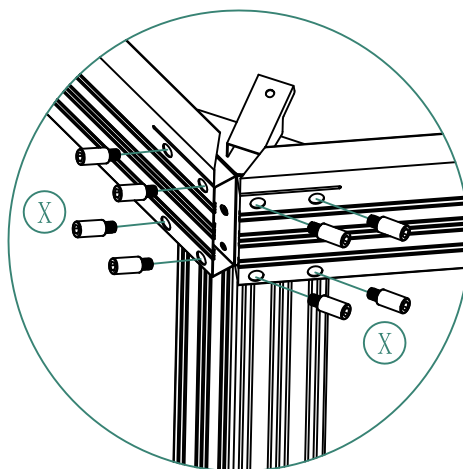
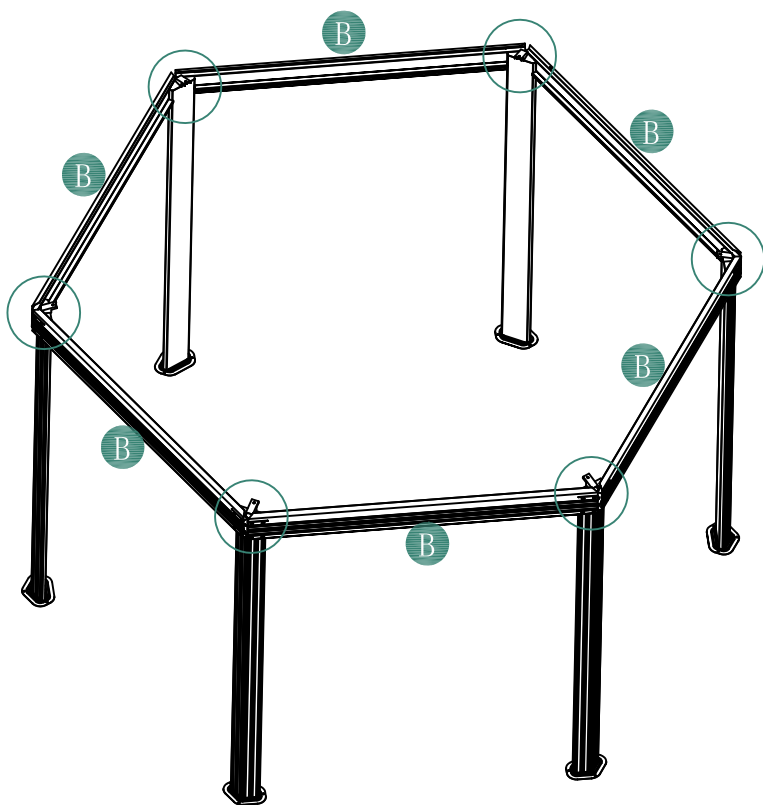

step3

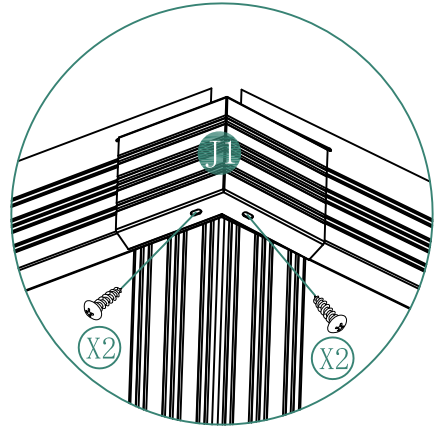
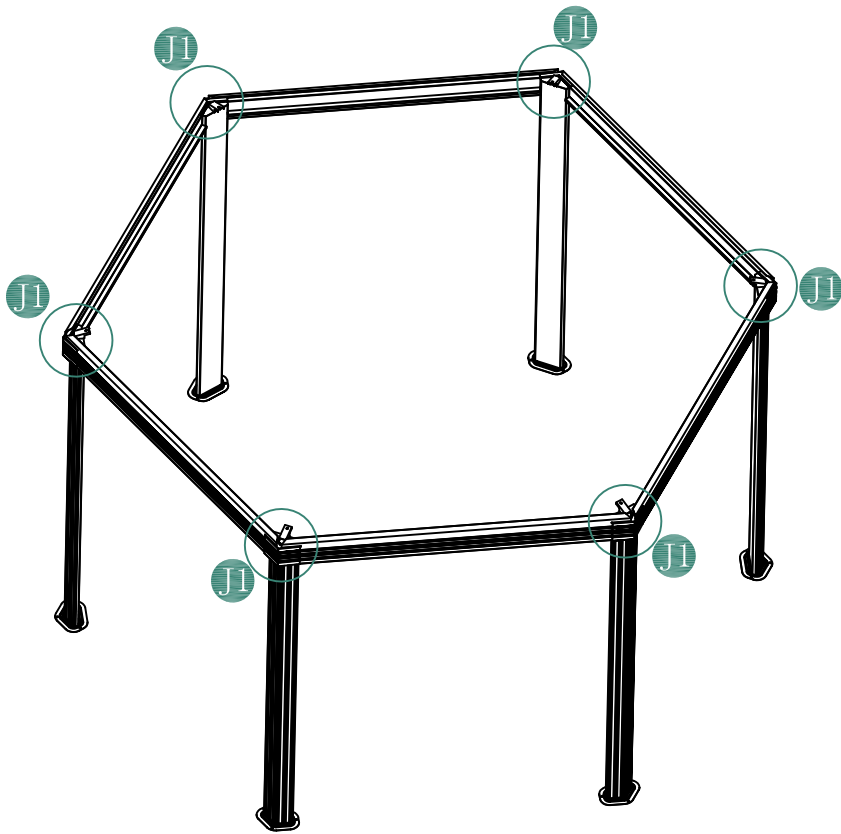

step4

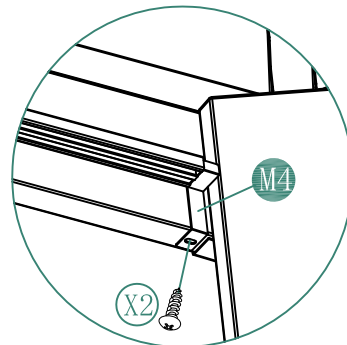
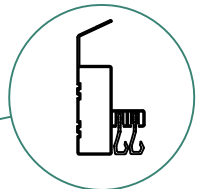
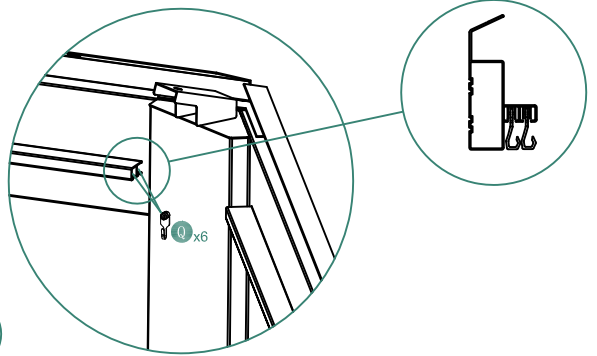

M4

step5

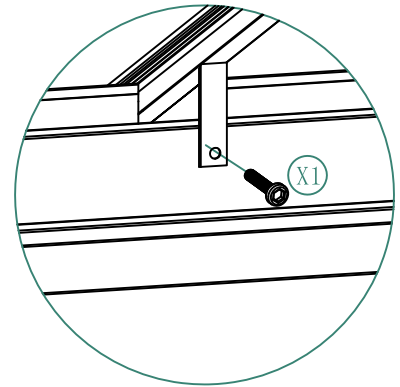
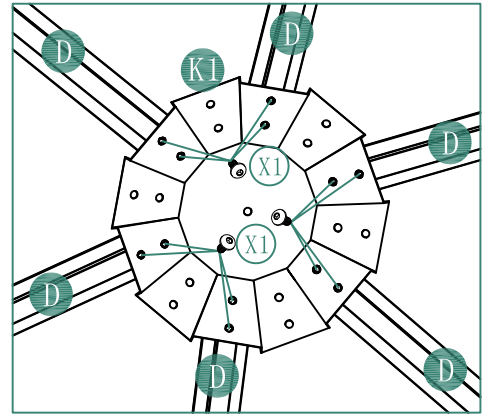
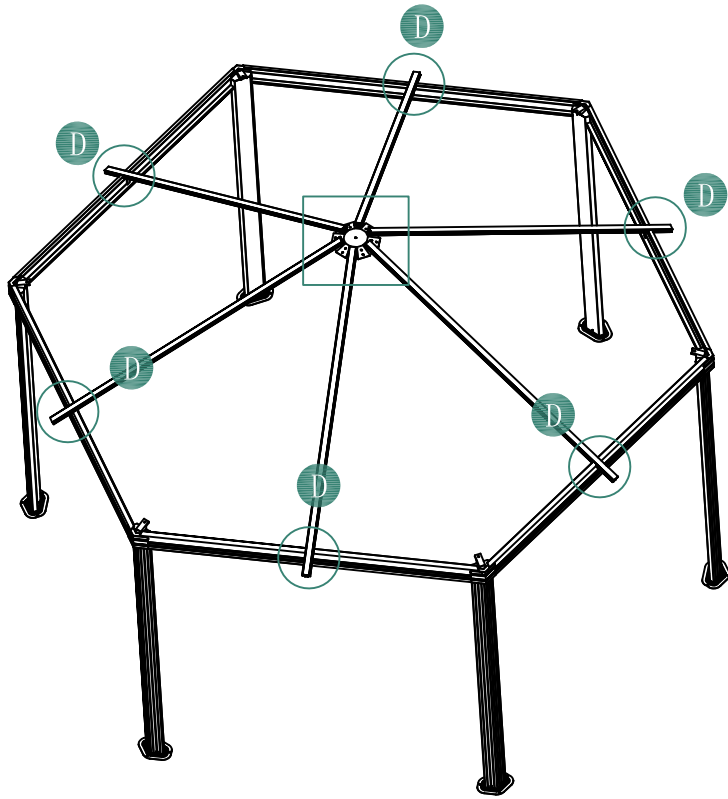

step6

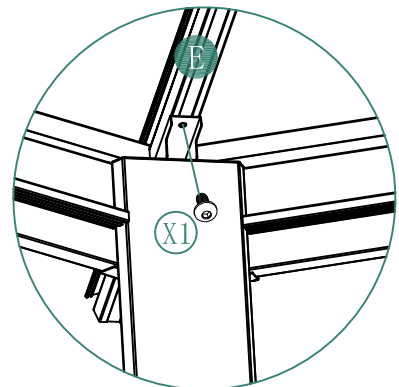
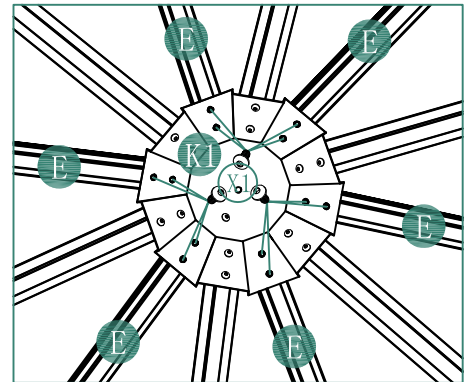
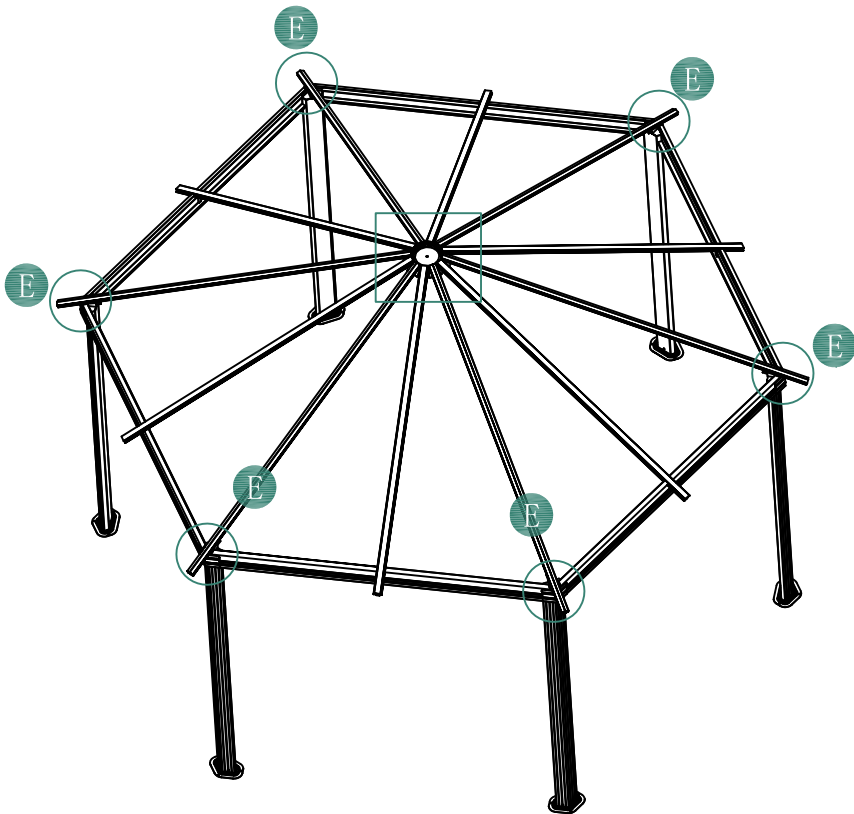

step7

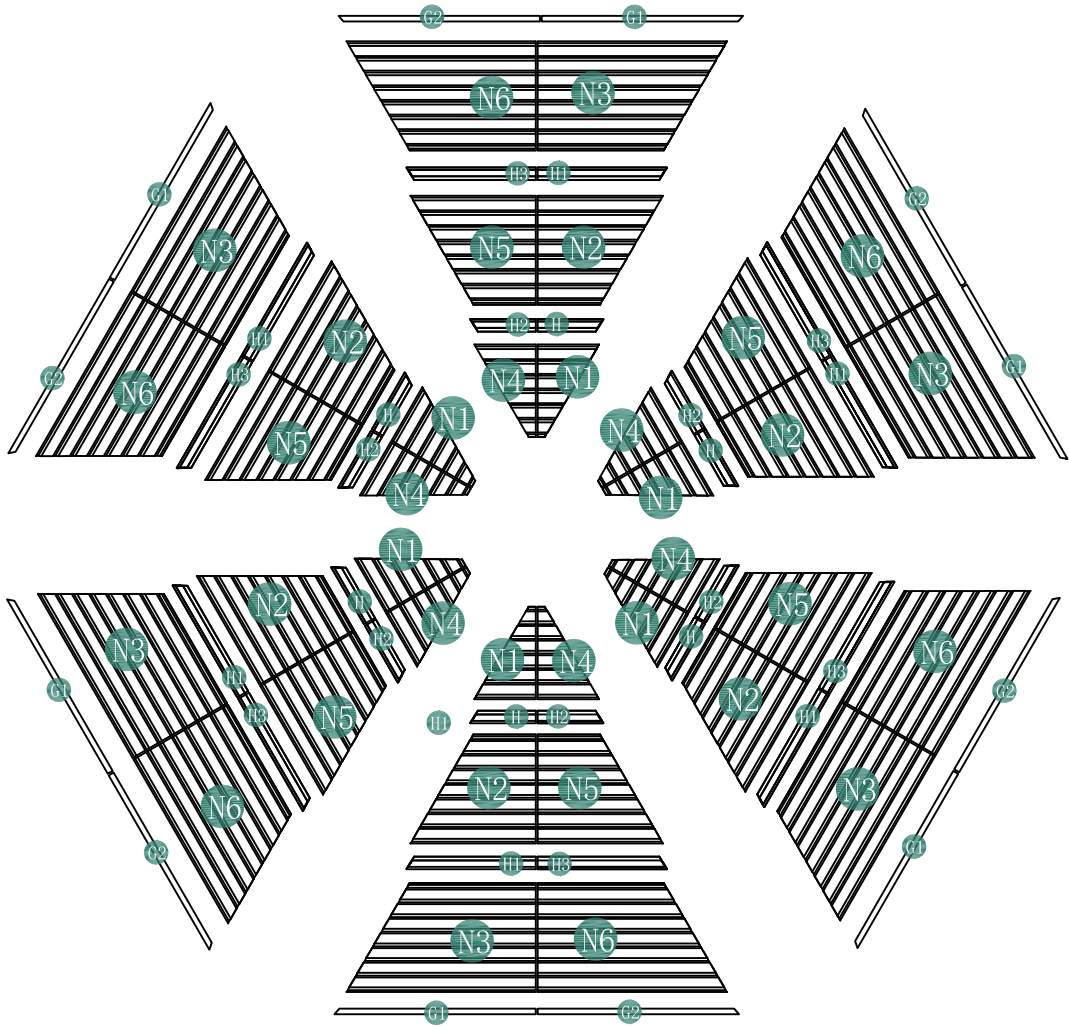

step8

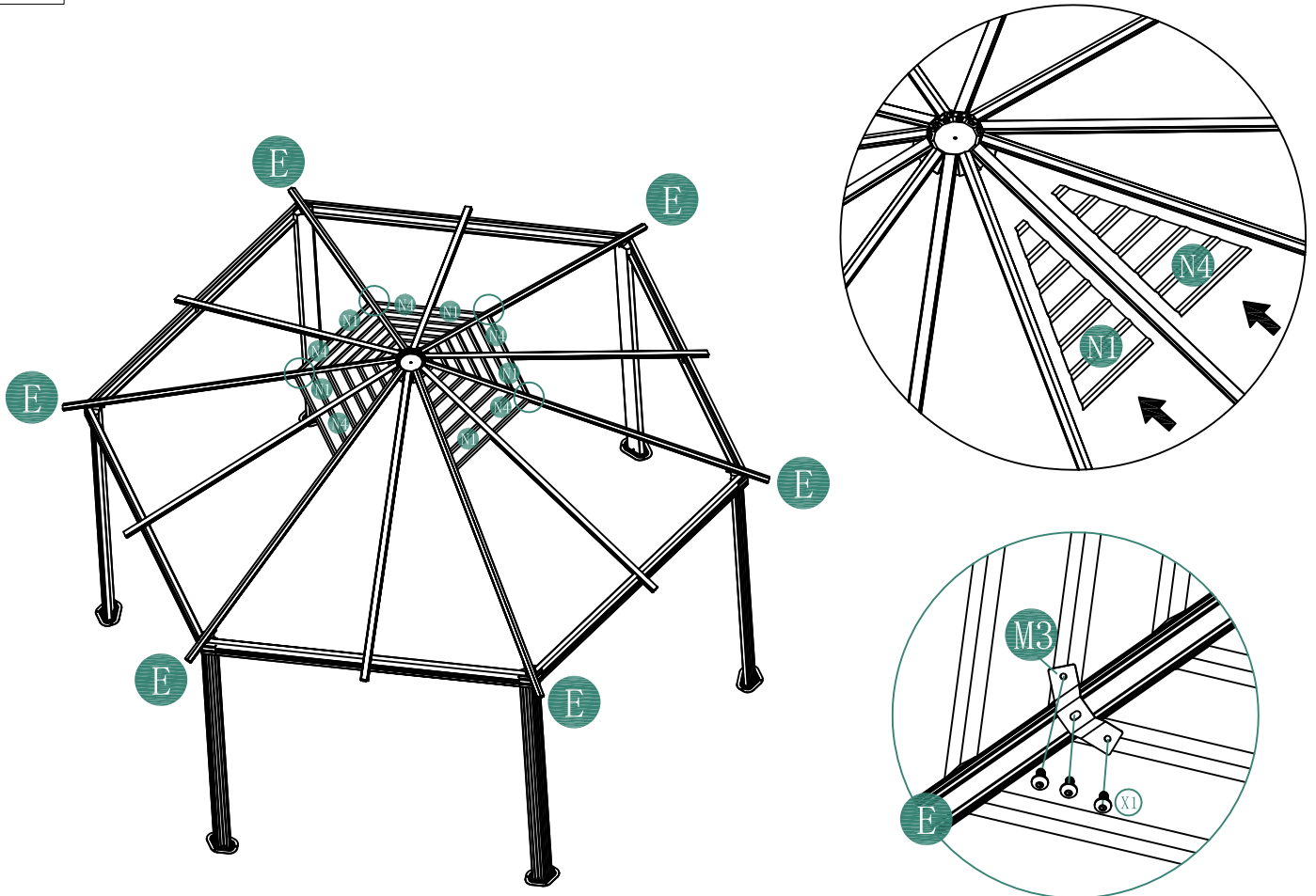

step9

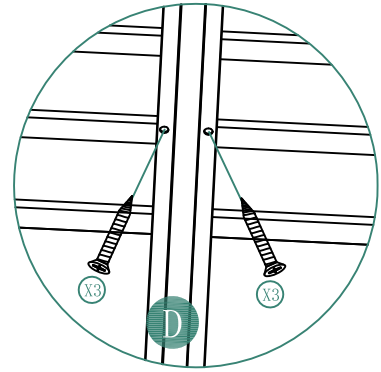
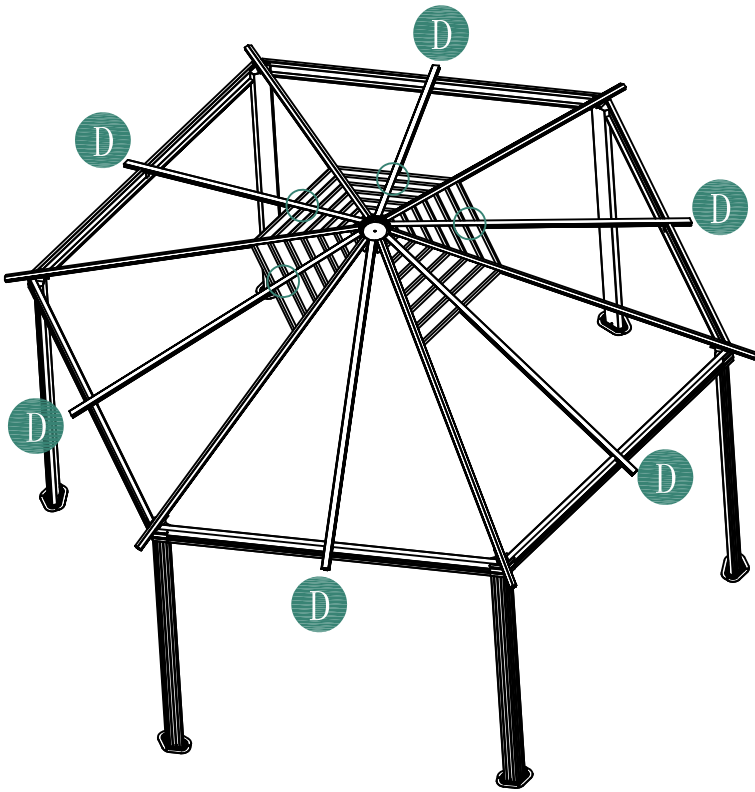

step10

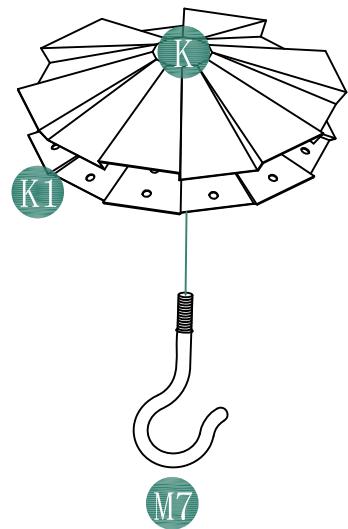
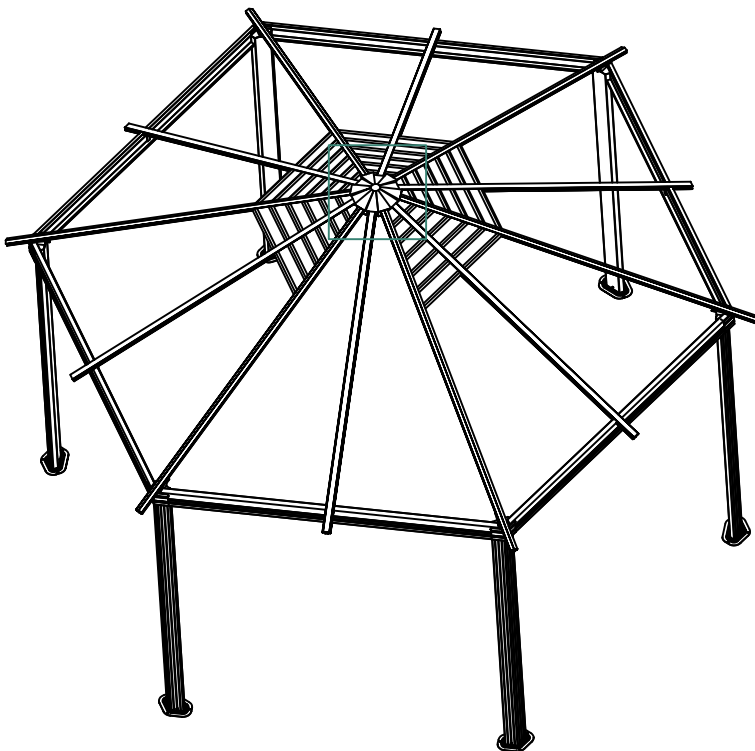

step11

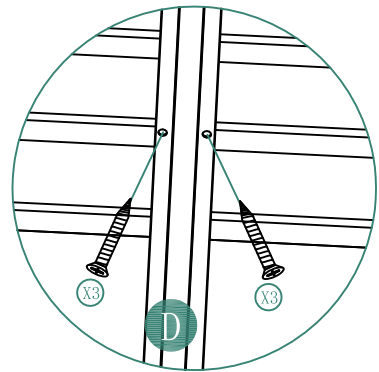
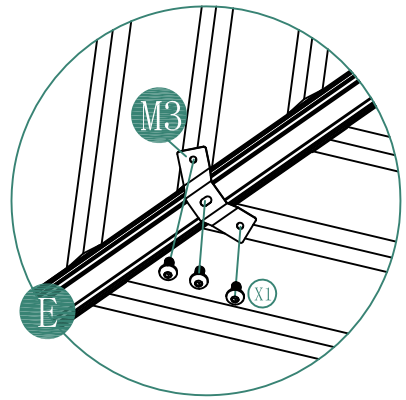
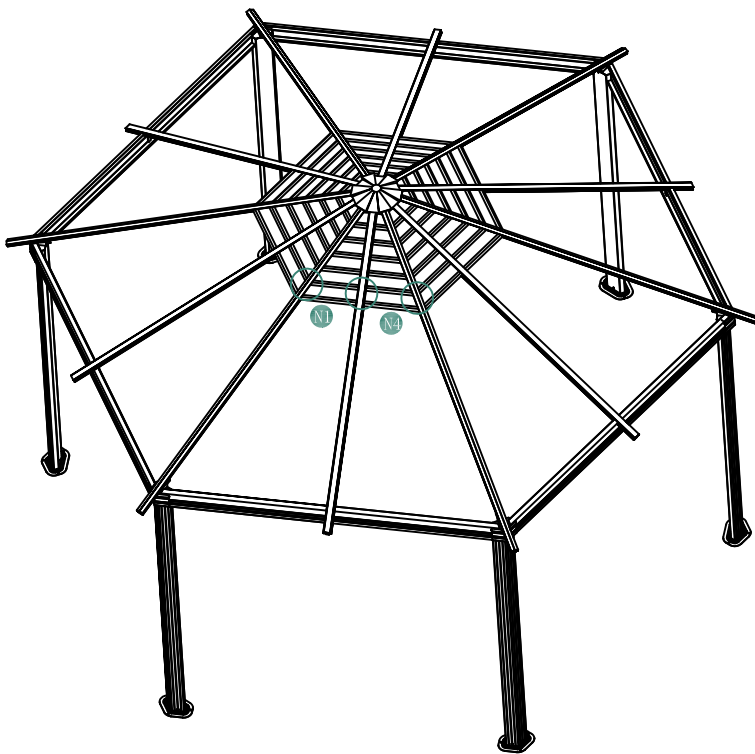

step12

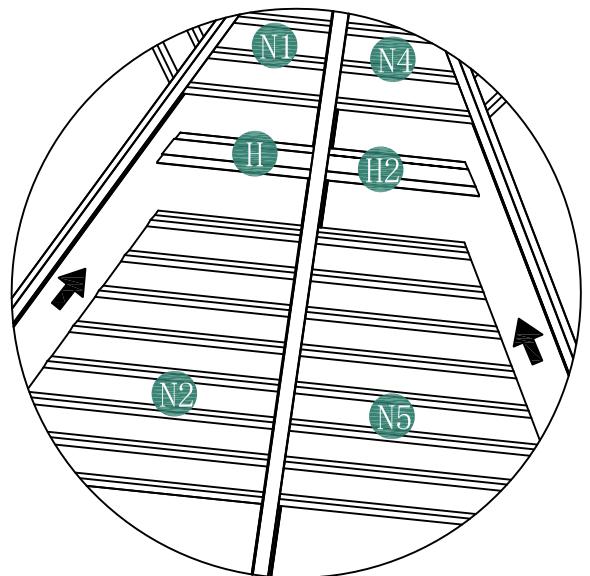
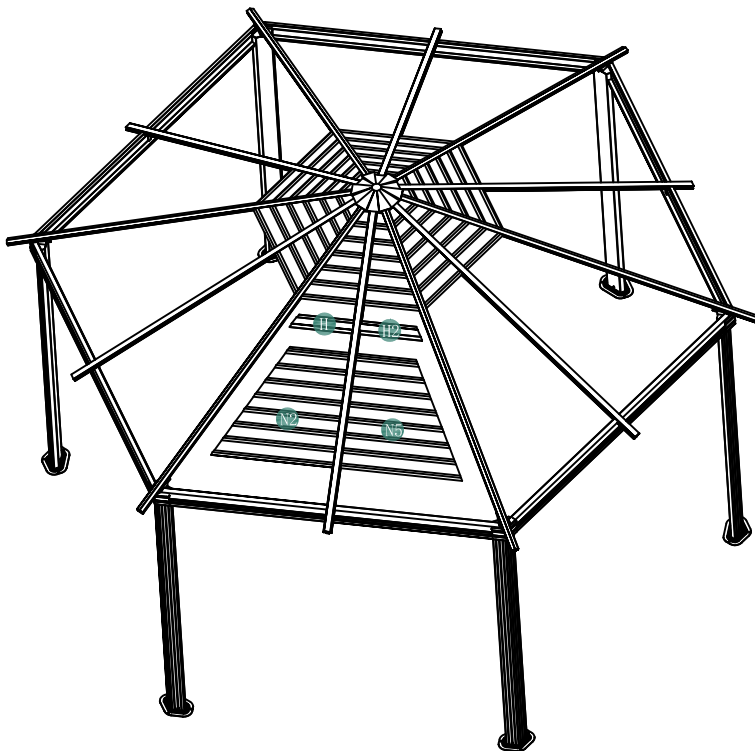

step13

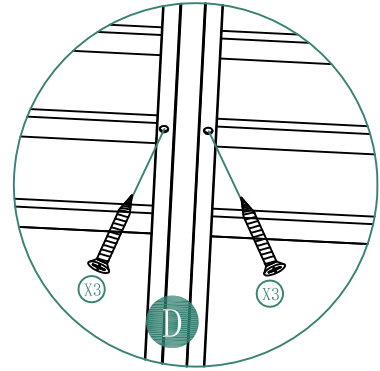
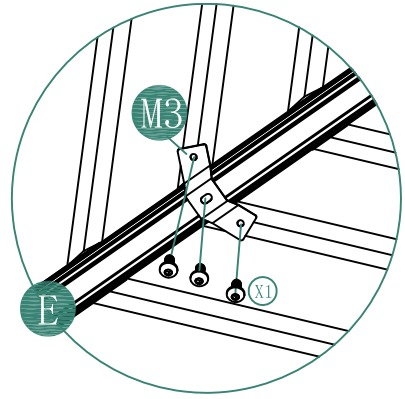
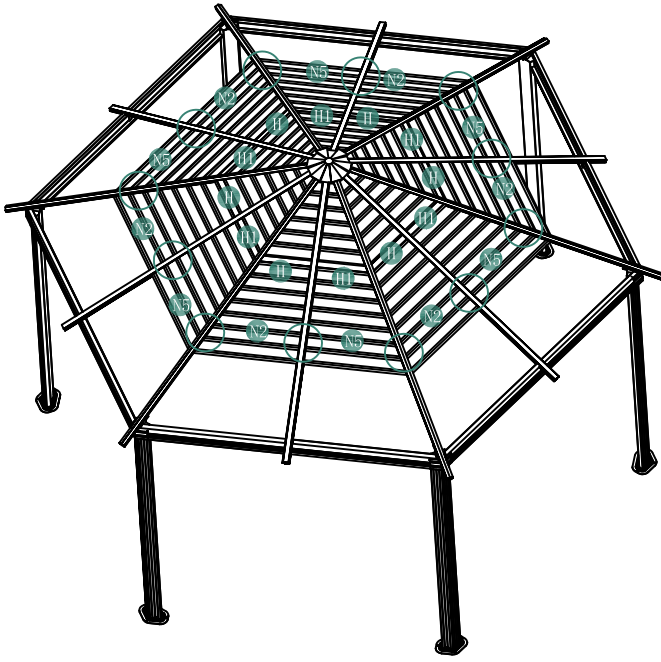

step14

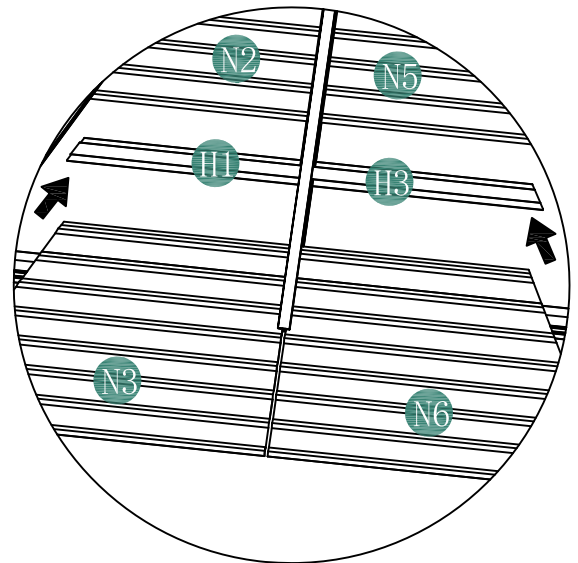
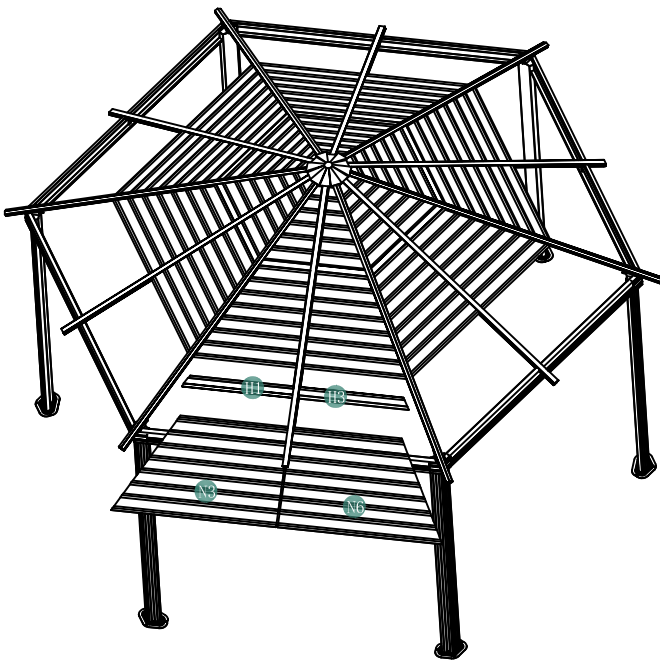

step15

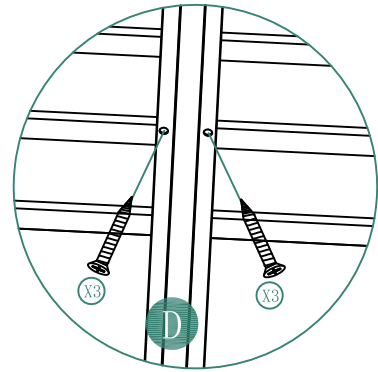
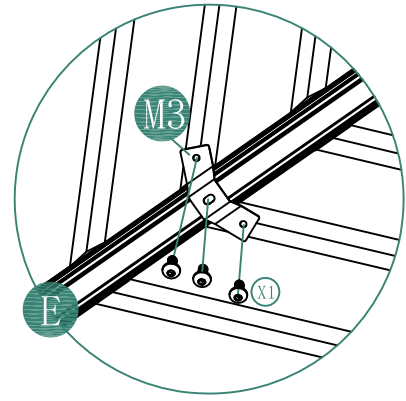
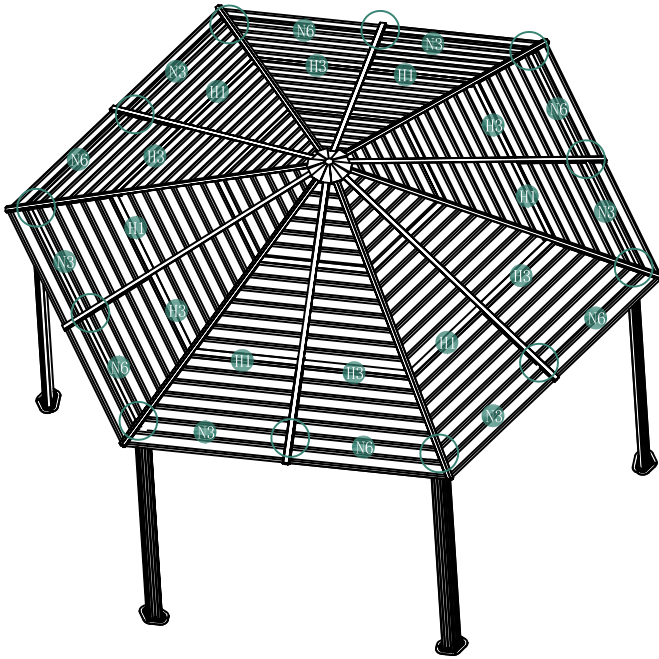

step16

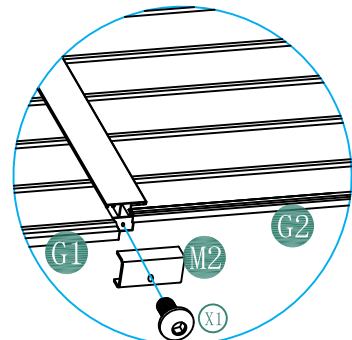
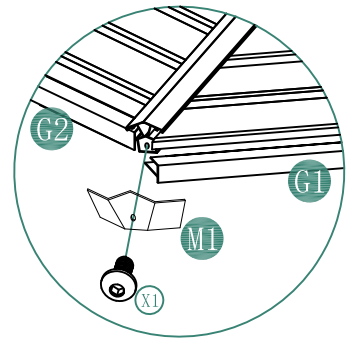
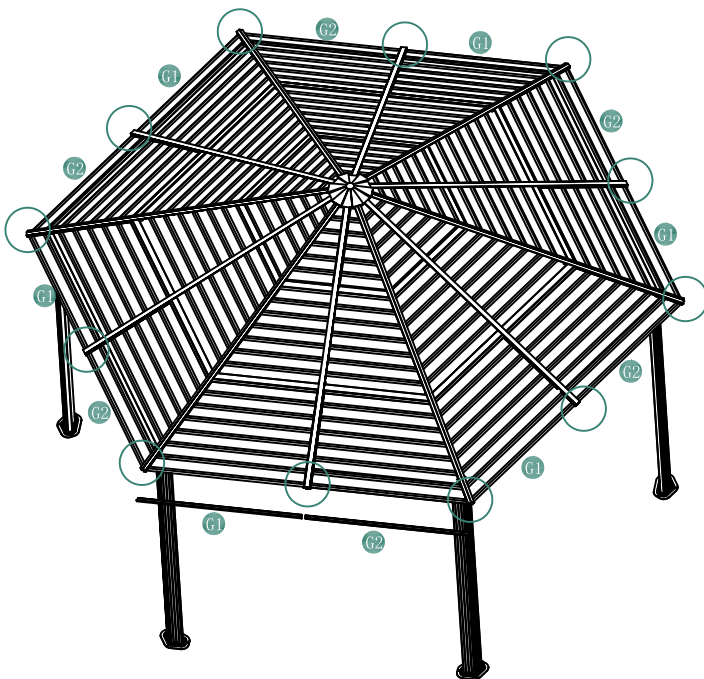

step17

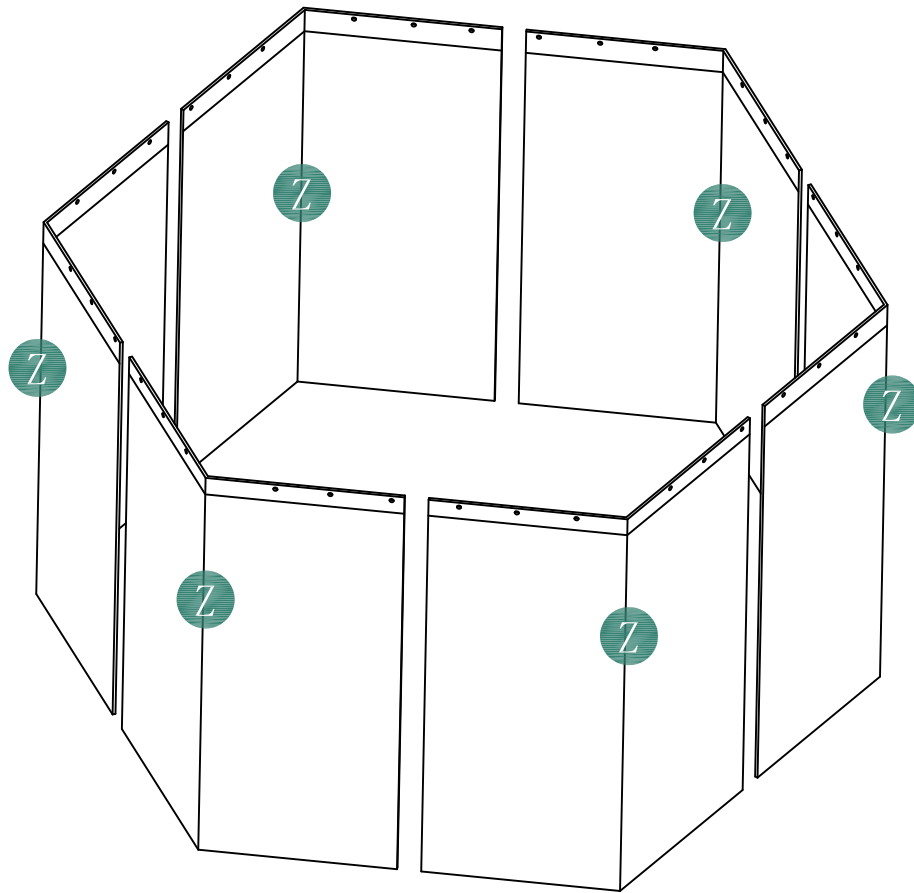

step18

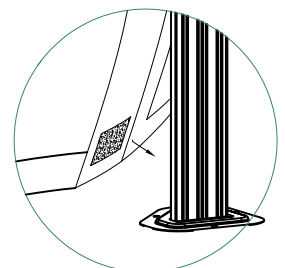
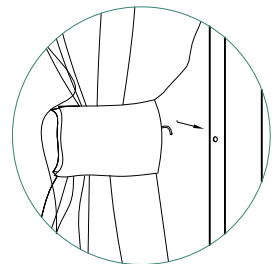
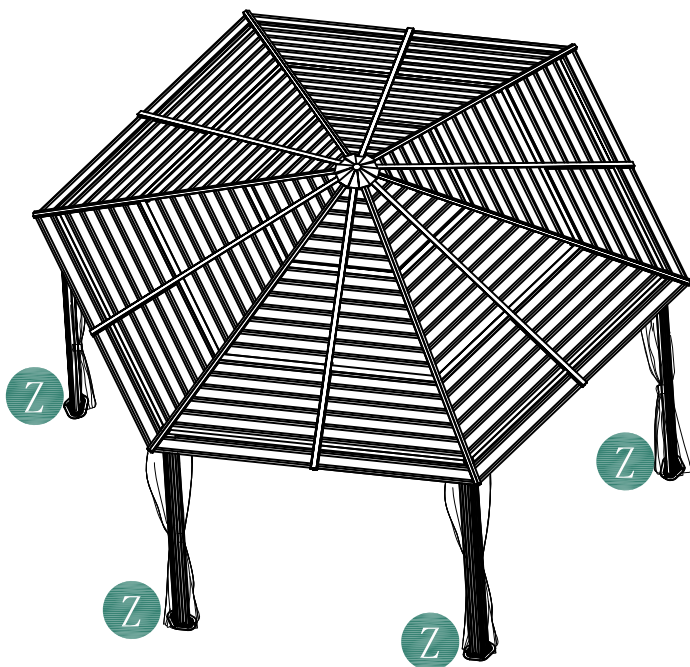
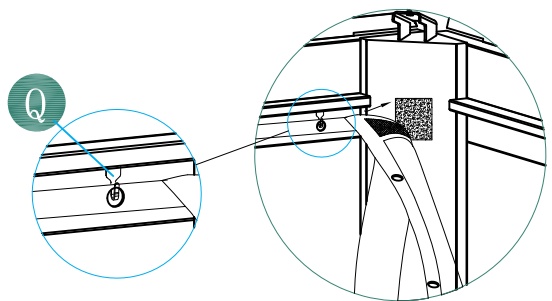
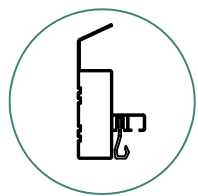

step19

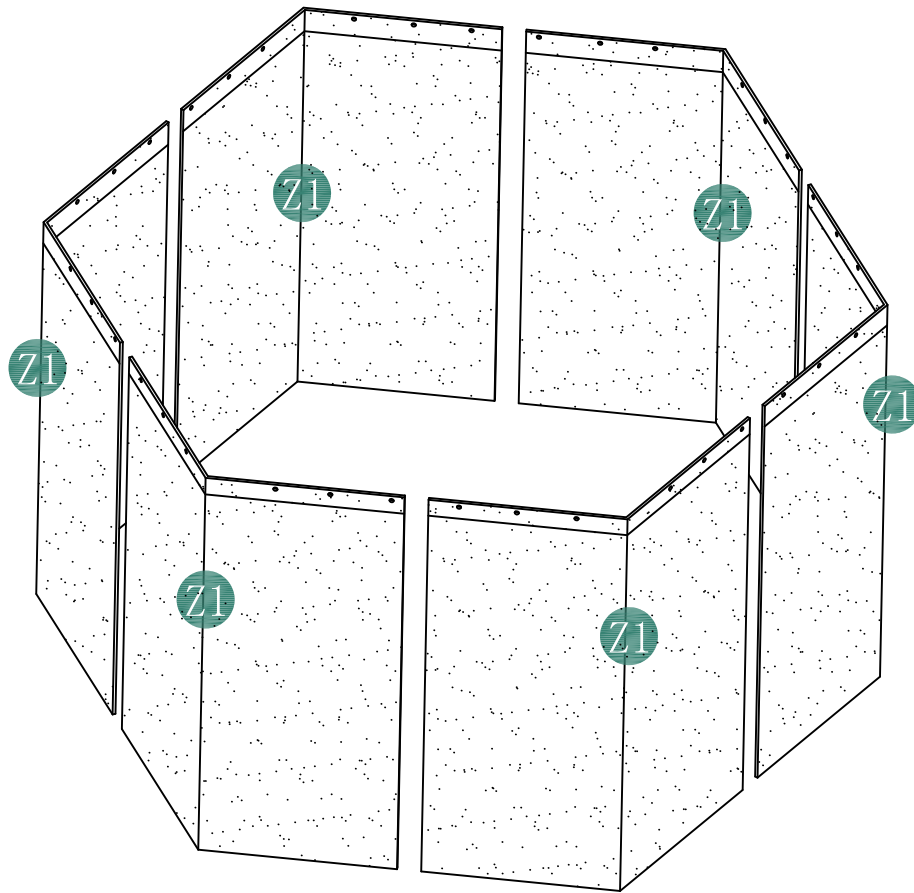

step20

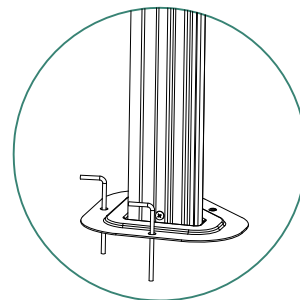
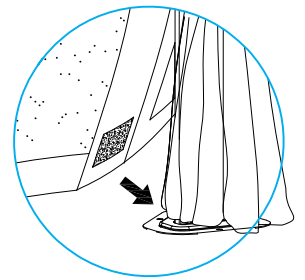
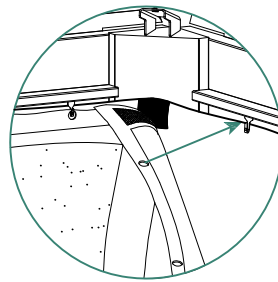
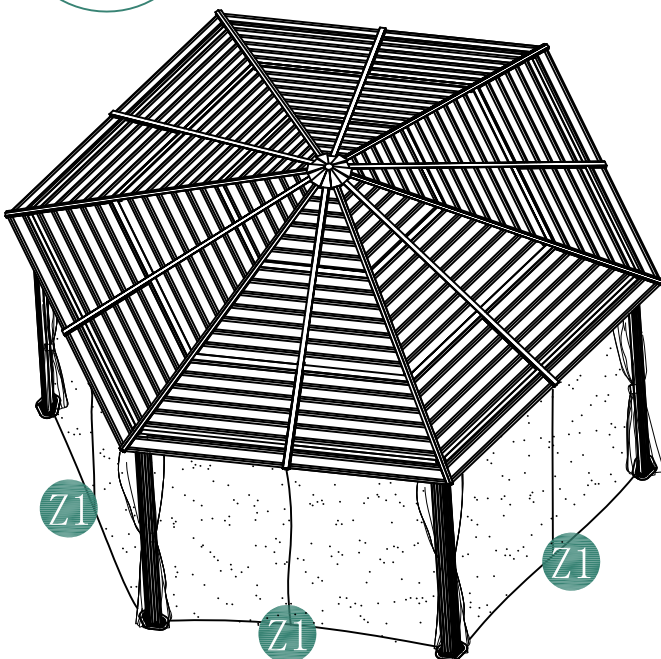
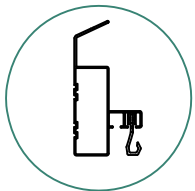

or

