

Assembly Instructions

Caution: You must read this before you proceed

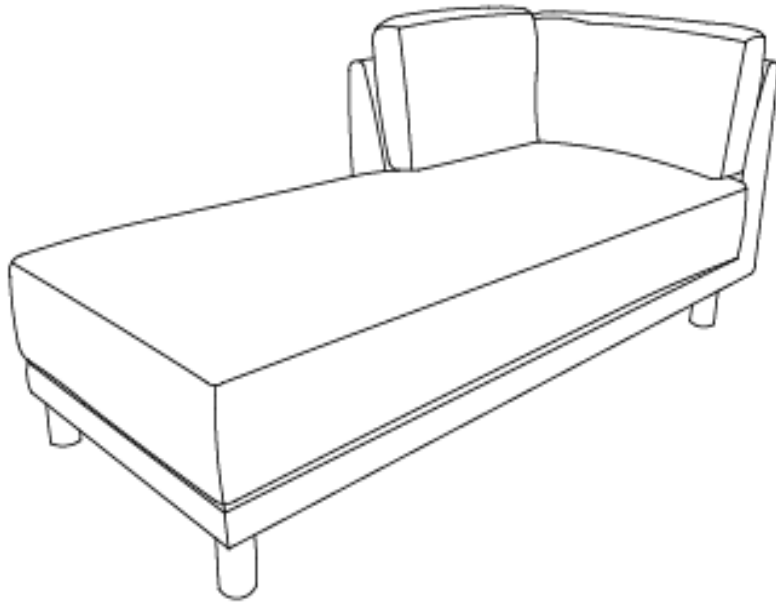



Please look in seat for hardware packs and legs.

Chaise



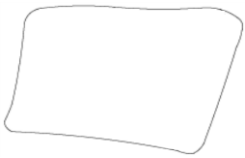
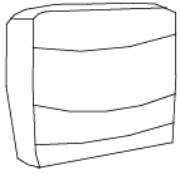
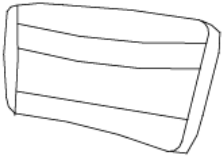

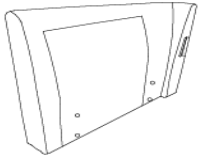

Part List

Label	Picture	Description	QTY
A	A line drawing of the seat base, showing a rectangular block with a slightly raised front edge and a small rectangular cutout on the right side. It is supported by four small legs.	Seat Base	1
B	A line drawing of a rectangular cushion cover with rounded corners and a slightly raised front edge.	Left Back Cushion Cover	1

C		Right Back Cushion Cover	1
D		Left Back Cushion Interior	1
E		Right Back Cushion Interior	1
F		Right Backrest	1
G		Left Backrest	1
H		Wood Leg	6

Hardware

Label	Picture	Description	QTY
①		Gaskets (available for Chaise Unevenness/Wobbles Adjustments)	9
②		Bolt(M8*70mm)	9

③		Spring Washer	9
④		Washer	9
⑤		Allen Wench	1

Assembly Preparation

Before
Beginning
Assembly:

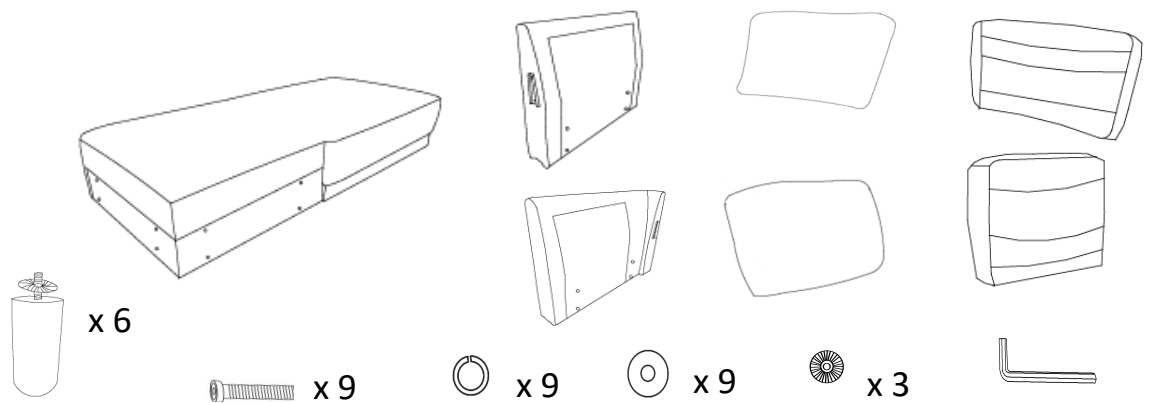

- Read instructions, cover to cover-



- Have 2 adults on hand for assembly-



- Do not assemble on flooring or carpet-



- Assemble on a clean non-marring surface (packing foam)-



- Save all packaging until finished-

Assembly Steps

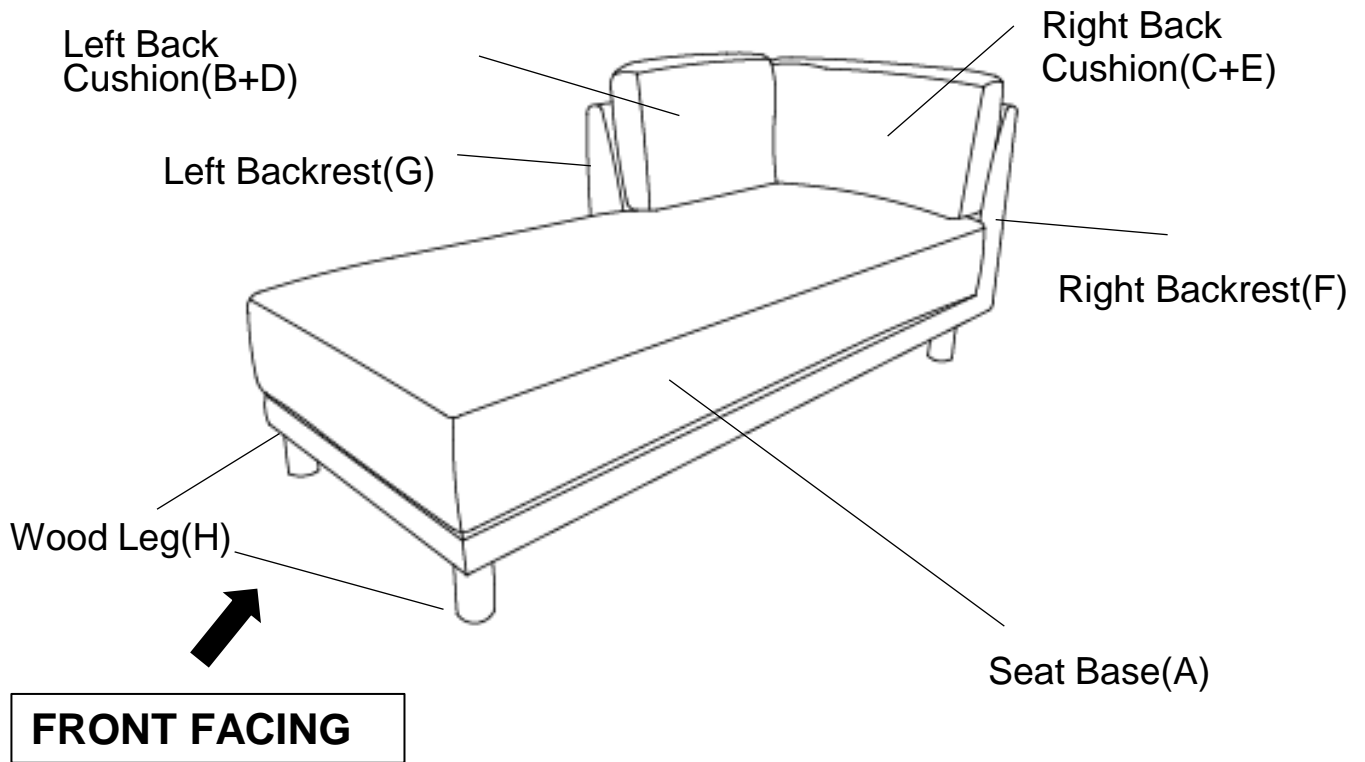

This Chaise has multiple parts and may require about 30 minutes to assemble. To give you an overview of the Chaise parts, the above picture is to help you put the various parts into perspective. Please read through the instructions below to familiarise yourself with the parts and steps before assembly.

Step 1

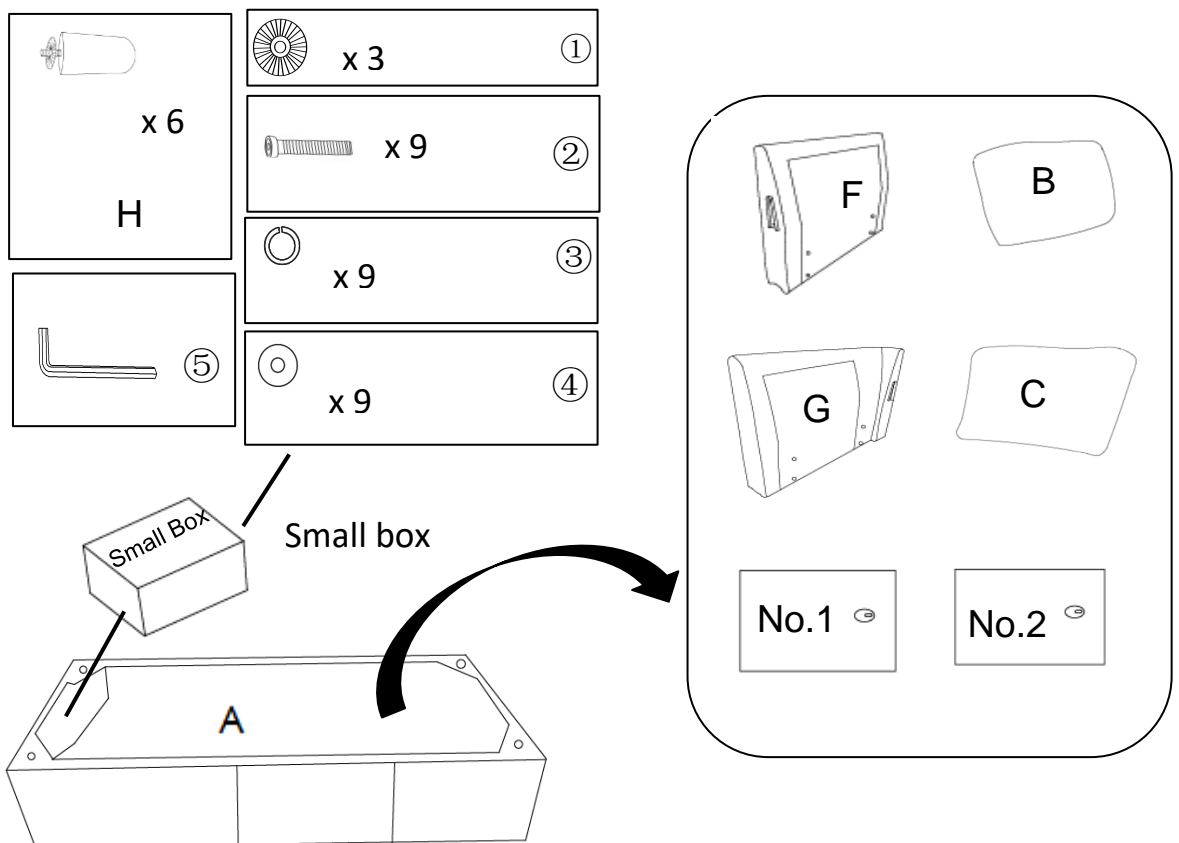

Open the carton and to take out the Small Box, Vacuum Bag(No.1). Vacuum Bag(No.2), Left Back Cushion Cover(B), Right Back Cushion Cover(C), Right Backrest(F) and Left Backrest(G) from the bottom of Seat Base(A). Then open the Small Box to take out the Wood Legs(H) and Hardware.

Step 2

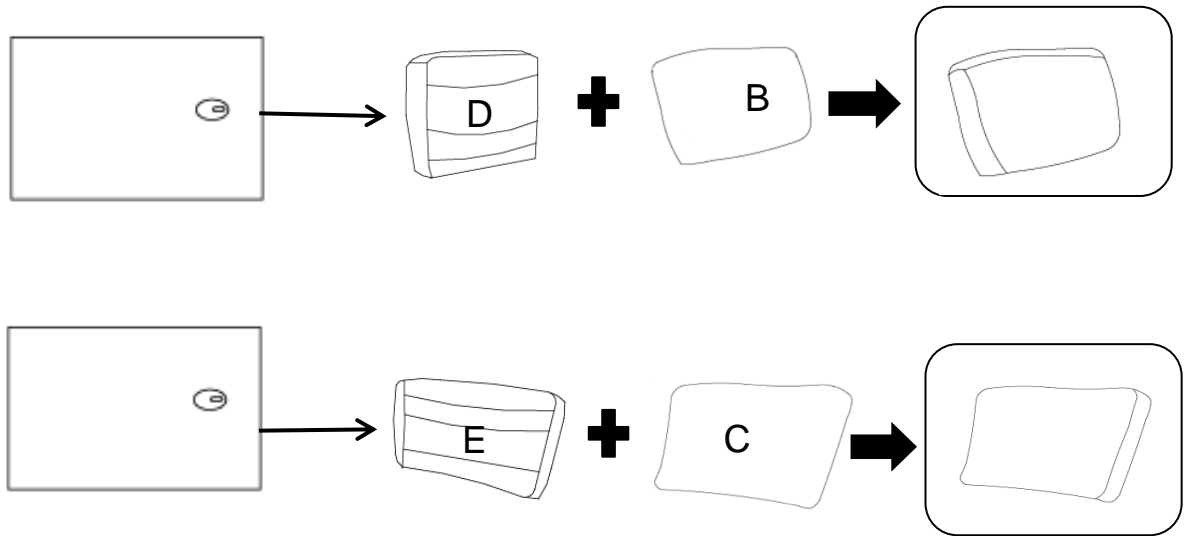

Open the Vacuum Bags to take out the Left Back Cushion Interior(D) and Right Back Cushion Interior(E), and put Left Back Cushion Interior(D) into the Left Back Cushion Cover(B) to be left back cushion and Right Back Cushion Interior(E) into the Right Back Cushion Cover(C) to be right back cushion. Place them on a clear surface and waiting for nex steps.

Step 3

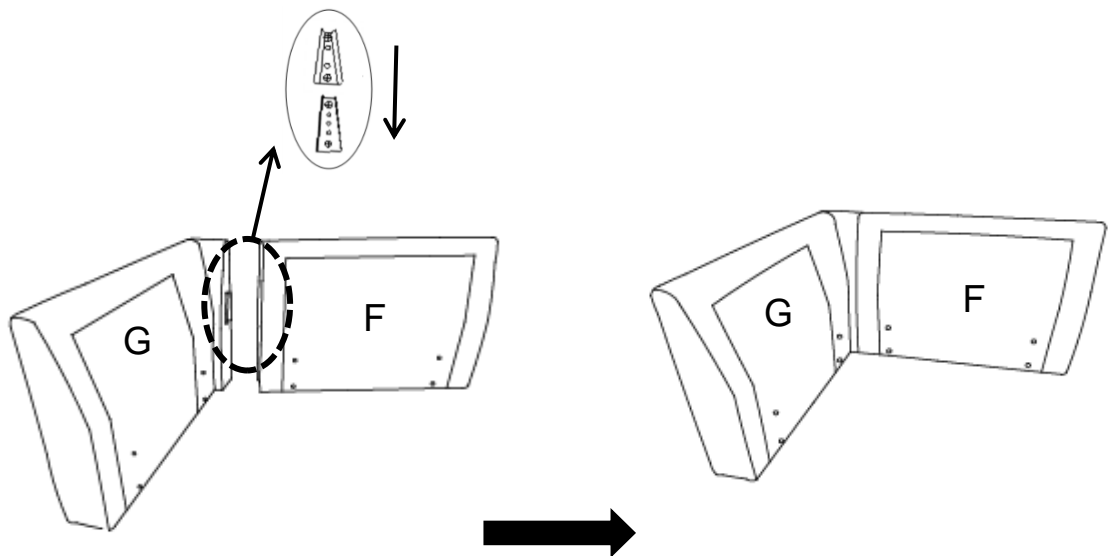

Align the mounting bracket on the Left side of the Right Backrest(F) with the one on the right side of Left Backrest(G), Then slide Right Backrest(F) downwards by hand pressing gently but firmly downwards until they lock into place.

Step 4

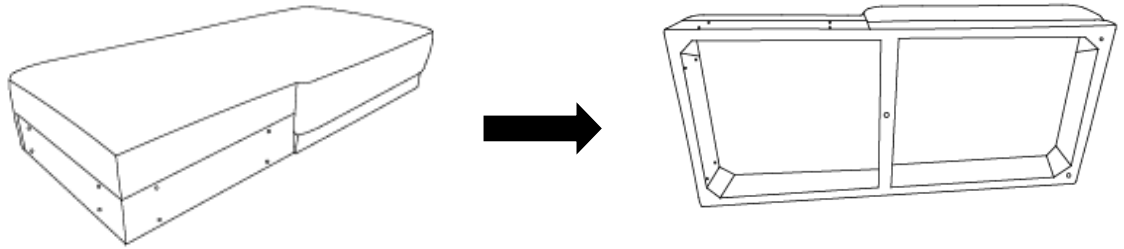

Turn the Seat Base(A) to the side on floor as the picture.

Step 5

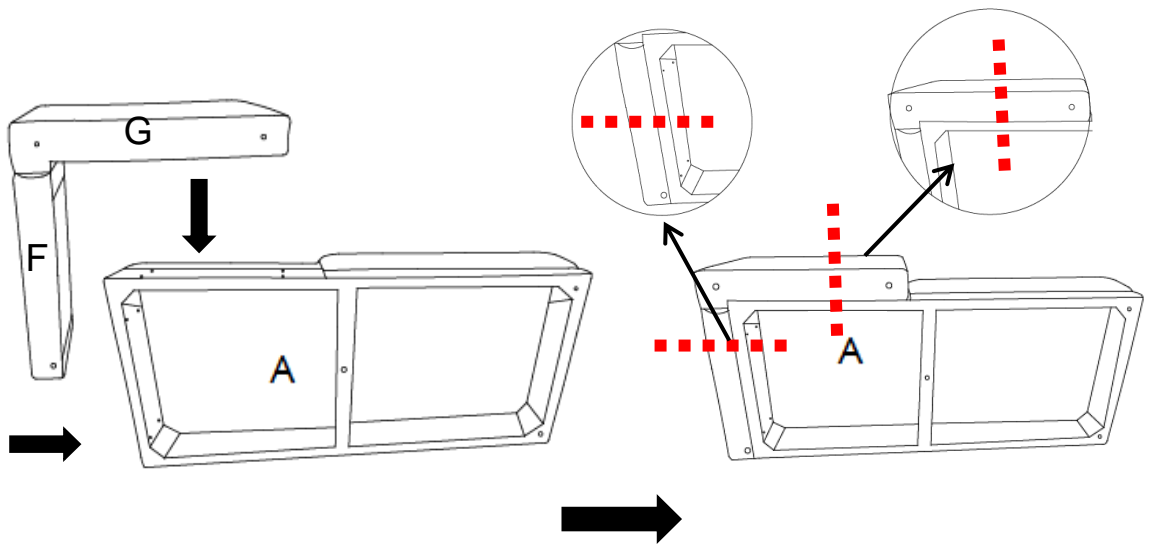

Put the Left Backrest(G) and Right Backrest(F) on the Seat Base(A) as the picture and and make sure the bottom at the same level.

Step 6

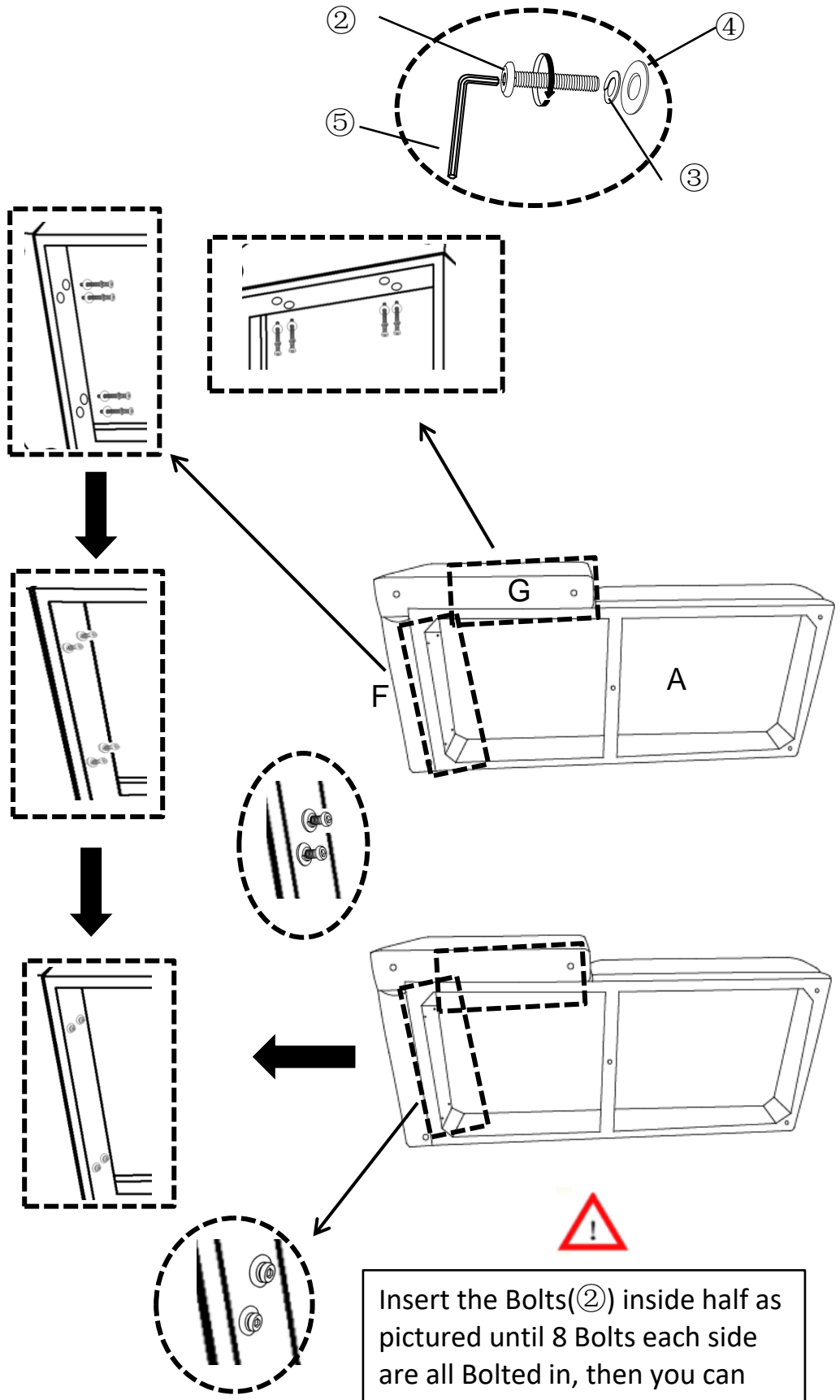

Insert the Bolts(2) inside half as pictured until 8 Bolts each side are all Bolted in, then you can tight all the bolts with Allen Wrench(5).

With assistance from your adult partner, place the whole product on a clean, non-marring surface.

Then attach using Bolts(②), Spring Washers(③) and Washer(④) with Allen Wrench(⑤). Pls don't tighten the Bolts and just to be bolted half-way until all bolted in, then tighten all the Bolts with Allen Wrench(⑤).

Note: The bottom of the Seat Base(A), Left Backrest(G) and Right Backrest(F) must be at the same level before assembly.

Step 7

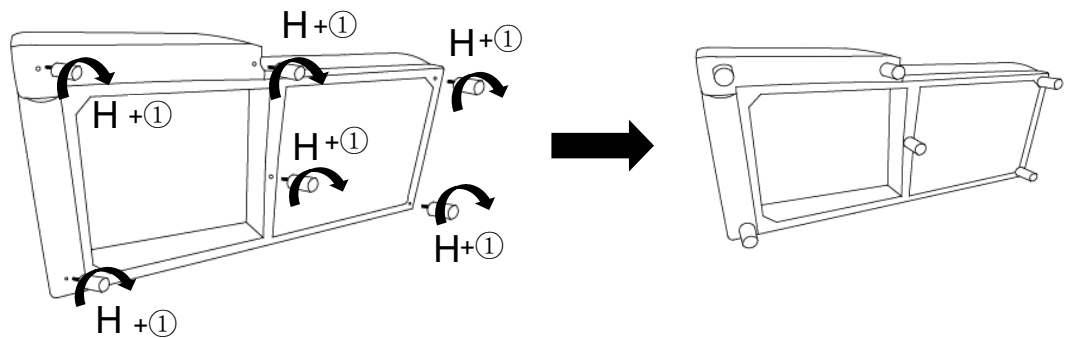

Install the Wood Legs(H) +With Plastic Gasket(①) at the bottom of the Sofa.

Tighten by turning the Leg clockwise.

Note: The use of Gaskets are OPTIONAL and are especially useful to help alleviate slight wobbleness. Some Legs may need more than one Gasket whilst some Legs may not need any.

Step 8



Don't turn the sofa directly, you need to lift the sofa up then put it down gently(in order to make sure the legs or legs support are not be damaged by incorrect operation.

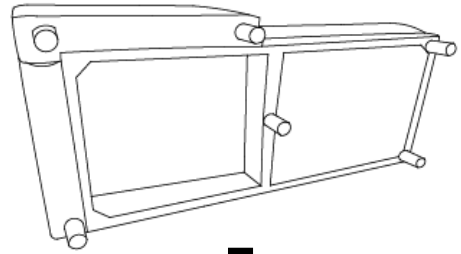

With assistance from your adult partner, lift the sofa up then put it down as the picture. Make sure all of the parts are connected in the right position and are sturdy.

Step 9

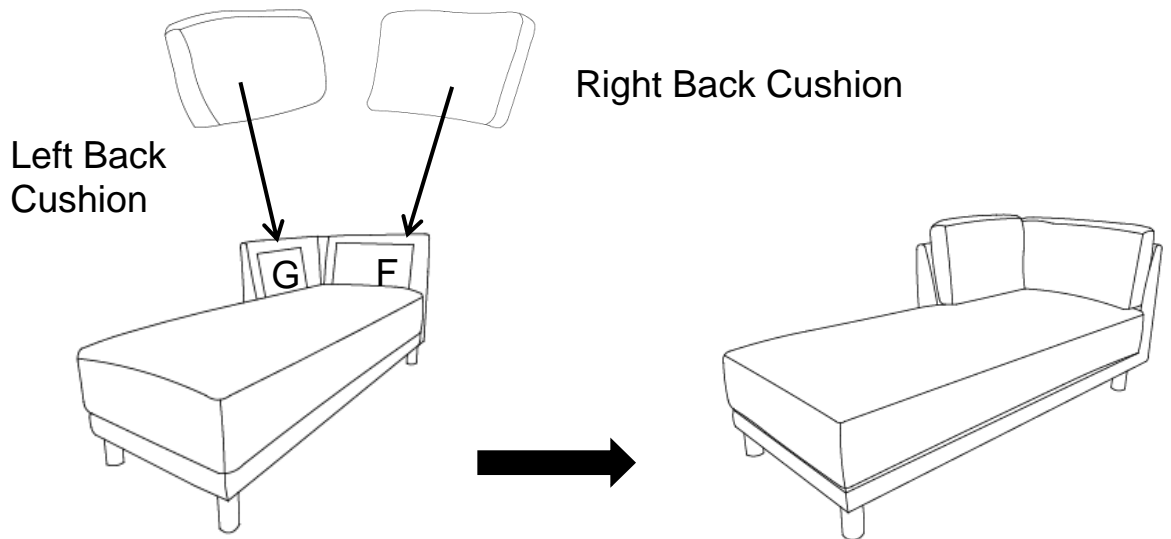











Place the Left Back Cushion(B+D) and Right Back Cushion(C+E) on the seat Base and against to the Left Backrest(G) and Right Backrest(F) fixed with Velcro as picture above.

Make sure all parts are connected and securely locked into position.

Your Chaise Set is ready for use.

This Chaise Set can only be used on a flat, level surface.

Care & Maintenance

	<ul style="list-style-type: none"> Furniture may scratch floors. We recommend using furniture pads to protect your floors.
	<ul style="list-style-type: none"> Do not put hot items directly on furniture surface.
	<ul style="list-style-type: none"> Do not clean furniture with harsh cleansers or polish.
	<ul style="list-style-type: none"> Do not place furniture under direct sunlight.
	<ul style="list-style-type: none"> Do not place furniture near heating or cooling vents.
	<ul style="list-style-type: none"> Do not write on furniture without a padded barrier to protect the surface.
	<ul style="list-style-type: none"> Do not place furniture outside . For indoor use only.
	<ul style="list-style-type: none"> Not for commercial use. For residential use only.
	<ul style="list-style-type: none"> Stains may be removed with mild soap solution and damp cloth.
	<ul style="list-style-type: none"> Children should not climb or jump on the furniture.
	<ul style="list-style-type: none"> Dust and pick-up spills using a clean, non-colored, lint-free cloth.

Questions & Answers about Proposition 65

• What is Proposition 65?

Proposition 65 requires businesses to provide warnings to Californians about significant exposures to chemicals that cause cancer, birth defects or other reproductive harm. These chemicals can be in the products that Californians purchase, in their homes or workplaces, or that are released into the environment. By requiring that this information be provided, Proposition 65 enables Californians to make informed decisions about their exposures to these chemicals.

Proposition 65 also prohibits California businesses from knowingly discharging significant amounts of listed chemicals into sources of drinking water.

Proposition 65 requires California to publish a list of chemicals known to cause cancer, birth defects or other reproductive harm. This list, which must be updated at least once a year, has grown to include approximately 900 chemicals since it was first published in 1987.

• What types of chemicals are on the Proposition 65 list?

The list contains a wide range of naturally occurring and synthetic chemicals that include additives or ingredients in pesticides, common household products, food, drugs, dyes, or solvents. Listed chemicals may also be used in manufacturing and construction, or they may be byproducts of chemical processes, such as motor vehicle exhaust.

• What does a warning mean?

If a warning is placed on a product label or posted or distributed at a workplace, a business, or in rental housing, the business issuing the warning is aware or believes that it is exposing individuals to one or more listed chemicals.

By law, a warning must be given for listed chemicals unless the exposure is low enough to pose no significant risk of cancer or is significantly below levels observed to cause birth defects or other reproductive harm.

• Where can I get more information on Proposition 65?

If you have specific questions on the administration or implementation of Proposition 65, you can contact OEHHA's Proposition 65 program at P65.Questions@oehha.ca.gov, or by phone at (916) 445-6900.