

# Wall Hung Installation Instruction





## READ ALL INSTRUCTIONS BEFORE UNPACKING THE PRODUCT

INSTRUCTIONS THAT, IF IGNORED COULD RESULT IN DEATH OR SERIOUS INJURY CAUSED BY INCORRECT HANDLING OR INSTALLATION OF THE PRODUCT. THESE INSTRUCTIONS MUST BE OBSERVED FOR SAFE INSTALLATION.

**CAUTION!**



**TWO PERSON  
LIFT REQUIRED**

**2 PEOPLE ARE REQUIRED TO LIFT AND DURING  
ENTIRE INSTALLATION OF THIS PRODUCT**



**INSTALLATION OF THIS PRODUCTS BY AN  
INEXPERIENCED INSTALLER MAY RESULT  
PERSONAL INJURY OR DEATH!**



We reserves the right to change, update, modify, alter, redesign this manual/product or its policies without prior notice!  
It is your responsibility to visit website to download or contact customer service for the most updated version of the installation instructions.

**We shall not be liable for any injuries or property damages in connection with this product during installation or use of this product!**

Limited warranty is void on any commercial installation.

We are not responsible for local code compliance for this product. Building and plumbing codes may vary from state-to-state in accordance to your location. We are not responsible for providing any compliance certifications.

We are not responsible to provide any type of certifications for this product.

Under no circumstances we are shall not be liable for any and all incidental damages sustained in connection with this product Neither manufacture, nor distributor, nor retailer is responsible for water damage or flood caused due to use of this product.

Under no circumstances We shall not be liable for any and all fees, cost of installation/reinstallation/removal, subsequent damage or transportation in case of the product defect.

## TOOLS REQUIRED FOR INSTALLATION



Soft Cloth  
or Blanket

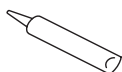

Silicone

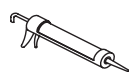

Silicone/  
Caulk Gun

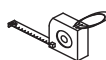

Tape  
Measure



Hammer



Safety Glass



Knife

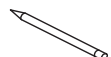

Pencil/Marker

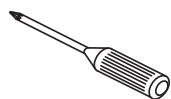

Philips  
Screwdriver

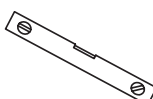

Level

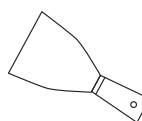

Putty Knife

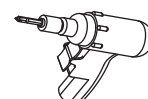

Drill



Drill Bit

## DIMENSIONS/TECHNICAL DATA

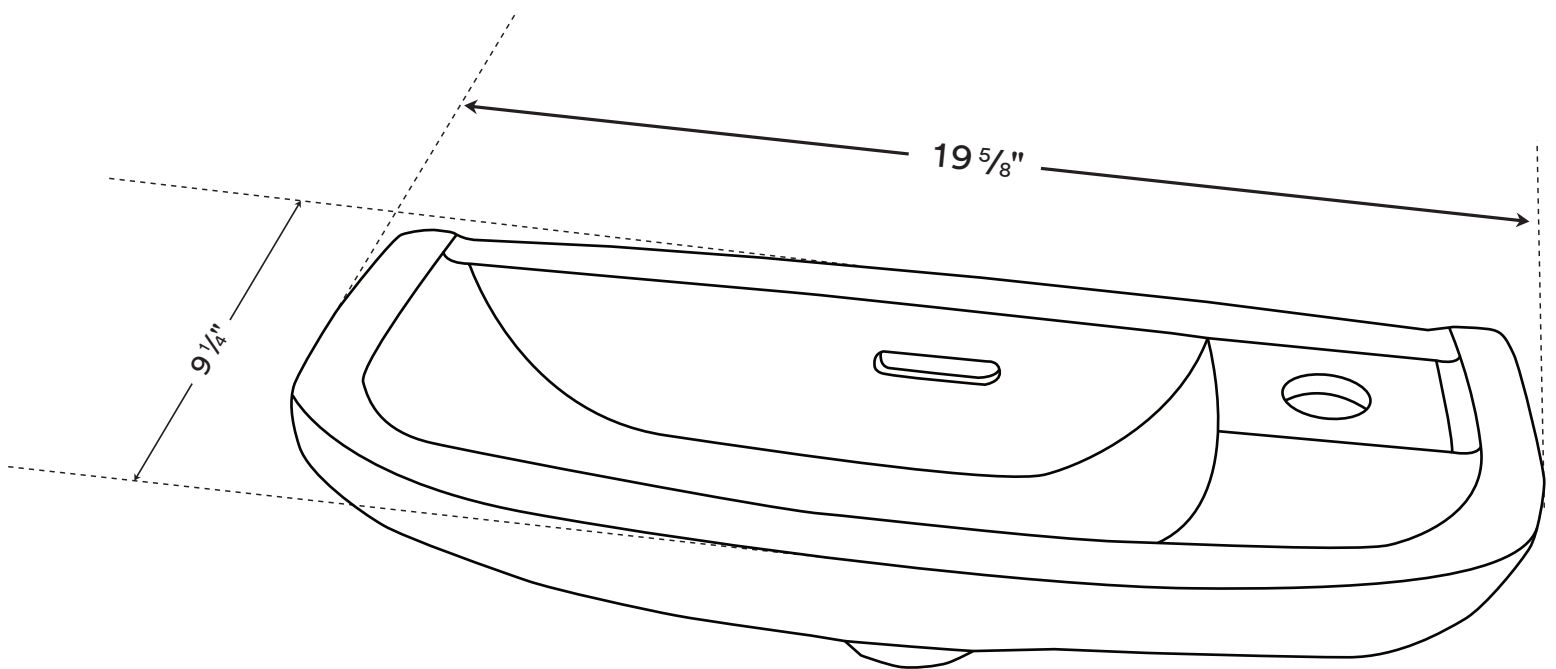

**ATTENTION!** Dimensions may vary by up to  $\frac{3}{8}$ ". It is highly recommended to pull all dimensions of actual model for installation and measuring purposes.

## INSTALLATION INSTRUCTIONS



**IMPORTANT!**  
Shut off main water supply prior to installation!

### Be sure to re-inforce wall before installation.

We recommend a 2"x12" securely fastened to wall studs at the desired height for your installation.

1. Determine the height you want. Place basin against the wall uses a level to make sure both sides are level — Mark location on wall for mounting holes on the back of the sink.
2. Position each metal mounting bracket against the underside rear of the basin and against the wall. Mark the location of mounting bracket holes on the wall.
3. Remove the basin from the wall. Wall should be reinforced before continuing.
4. Start to drill a hole in 2"x12" re-inforced wall for mounting hardware. Screw large wood screws provided into the wall.
5. Before replacing the basin, it would be convenient at this point to mount the faucet according to the manufacturer's instructions.
6. Slide sink onto bolts and ensure that it is level. Slide plastic flange washers and metal washers onto bolts — thread hex nuts on snugly.
7. Hold basin on wall brackets and ensure that it is level. Secure the sink to the wall using bolts through holes in the back of the sink.
8. Connect all supply tubes to the faucet. Connect trap and drain assembly as described by the manufacturer.



**NOTE: Determine whether your installation requires Hangers (pair) or a Bracket (one). These can be purchased separately to provide added support.**