

WARRANTY INFORMATION

- Do not expose the surfaces to direct sunlight or to extreme environmental conditions.
- Clean the surfaces preferable with a clean damp cloth, then dry with a clean towel.
- Do not use solvents or abrasive materials to clean the unit. If you decide to use a cleaning agent, test first on an area hidden from view.
- Replacement parts might be available to you at no charge, with an original proof of purchase and where a defect has arisen, wholly or substantially, as a result of faulty manufacturing, parts or workmanship during the Warranty Period.
- The warranty does not extend to regular wear and tear, nor the manufacturer assumes liability for damages or consequences due to accidents, incorrect assembly, negligence, improper use, modifications, or not heeding the above warnings.

Thank you so much for your support! We hope you enjoy your purchase. If there is any damage or missing accessories, please feel free to contact us for free replacement or refund.

Thank you !

TABLE OF CONTENTS

01 Warranty Information

02 Important Safety Instructions

02 Tools Needed

04 Parts List

06 Assembly

IMPORTANT SAFETY INSTRUCTIONS

- Check if all the parts are complete before installation.
- Read through the instructions before installing the cabinet.
- Keep the small parts away from children to avoid the risk of swallowing.
- Screw the cabinet to the wall to avoid the risk of falling down.

TOOLS NEEDED

Screws Driver -1PC



(Not included)

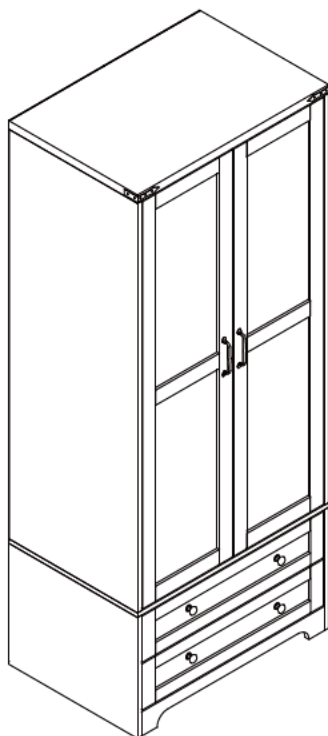

General Assembly Guidelines

- I. Ensure that all parts and hardware are available before beginning assembly.
- II. Follow each step carefully to ensure the proper assembly of this product.
- III. The three main types of hardware used to assemble this product are: wood dowels, screws and bolts.
- IV. A Phillips head screwdriver is required for the assembly of this product.



V. Cam bolt and Cam lock Assembly Instruction.

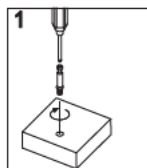

1
Cam bolt
vertical installation

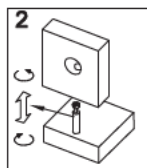

2
Cam bolt is
adjustable

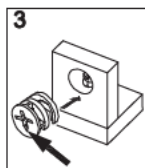

3
Cam lock
the arrow is towards
the Cam bolt

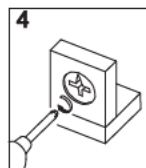

4
180°
Ensure locking
the Cam bolt

VI. Concealed hinges are three-way adjustable.

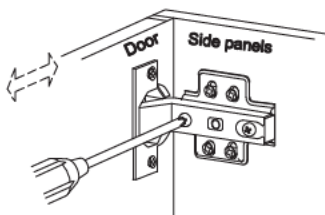

Horizontal
by screw adjustment

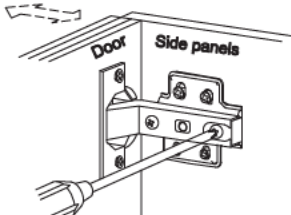

In-and-Out
by loosening the hinge-arm
mounting screw or via cam
adjustment

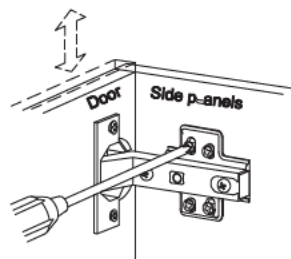





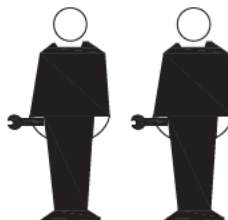

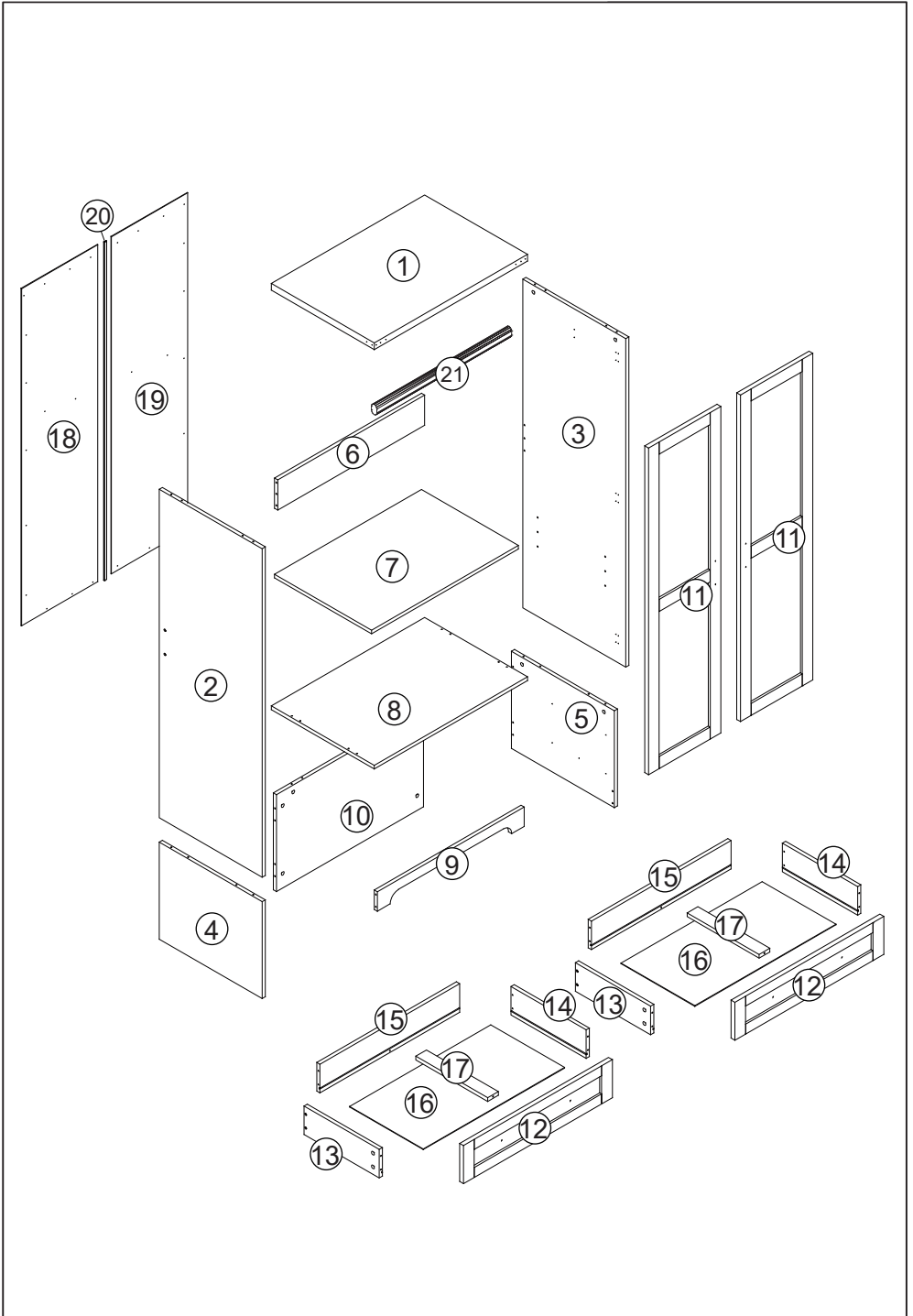







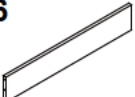



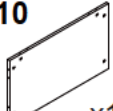

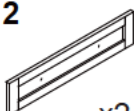























Vertical
Via slots in the mounting
plate or via cam adjustment

VII. Two people are recommended for ease in the assembly of this product.





Packing List

1  x1	2  x1	3  x1	4  x1	5  x1	6  x1
7  x1	8  x1	9  x1	10  x1	11  x2	12  x2
13  x2	14  x2	15  x2	16  x2	17  x2	18  x1
19  x1	20  x1	21  x1			
A  x26	B  x26	C  x14	D M4x40  x20	E M3.5x12  x64	F  x2
G  x4	H  x2	I M4x22  x4	J  x2	K M4x14  x10	L  x2
M M3x14  x8	N M4x14  x4	O  x2	P  x6	Q M3x14  x26	R  x4
S  x4	T  x4	CL  x2	CR  x2	DL  x2	DR  x2

Step 1

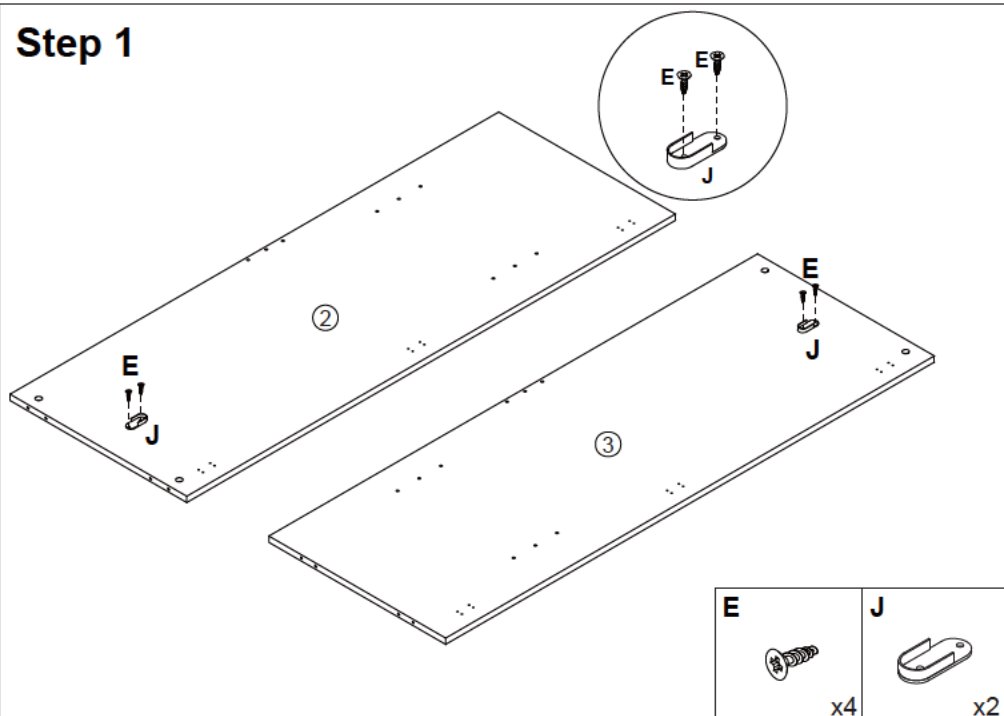

Step 2

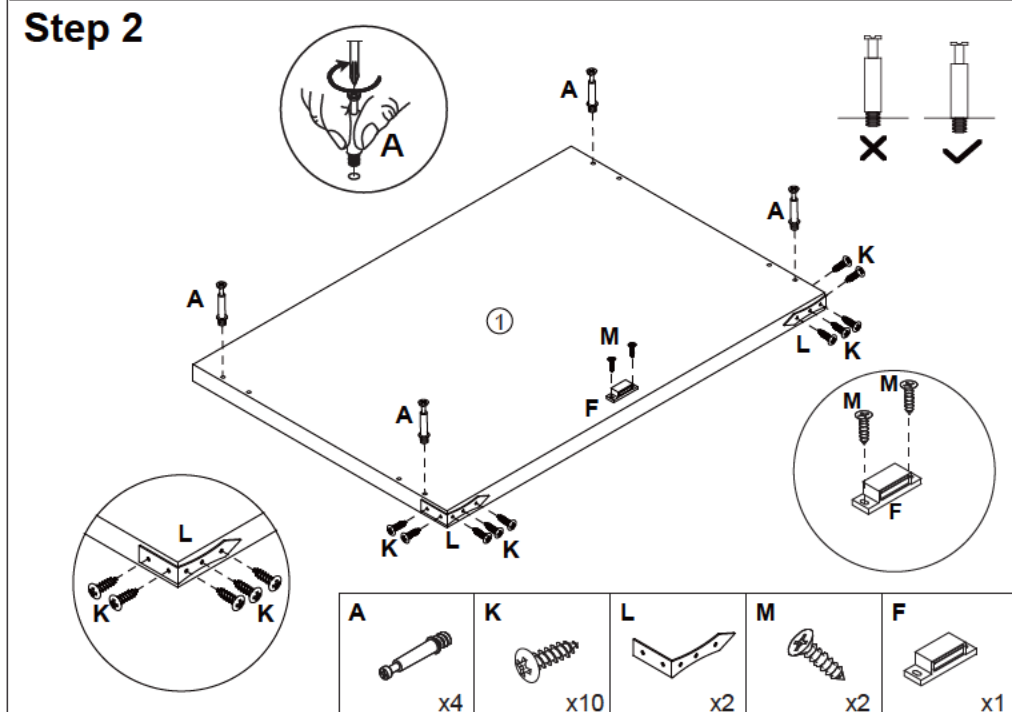

Step 3

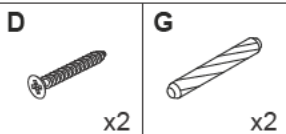
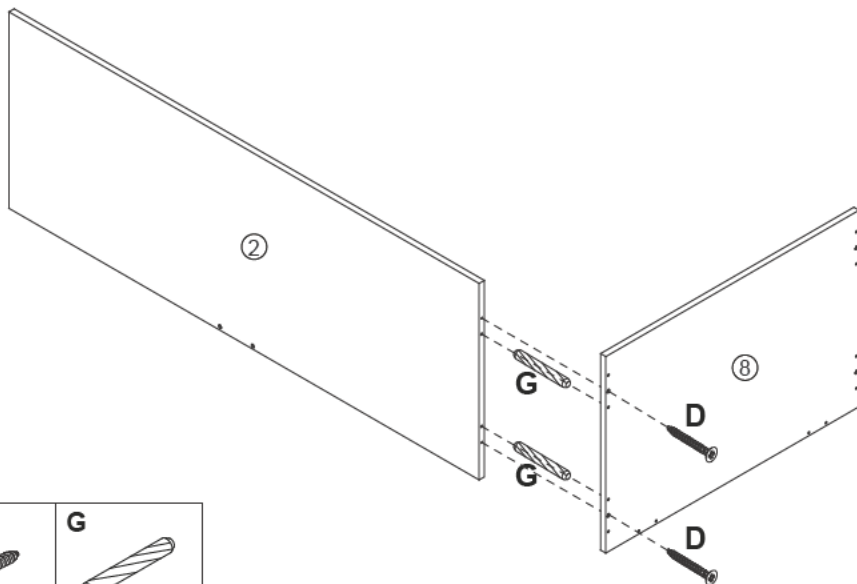

Step 4

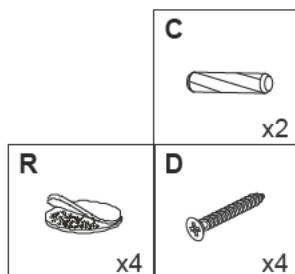
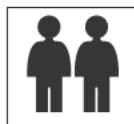
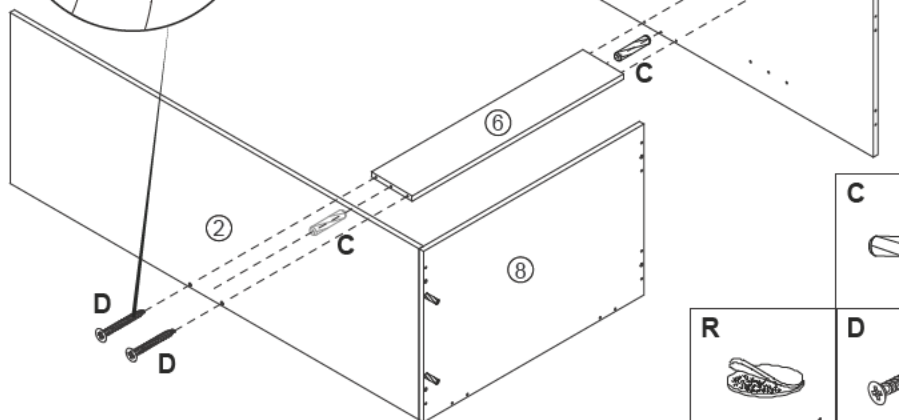
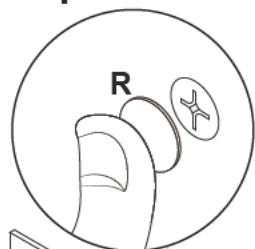

Step 5

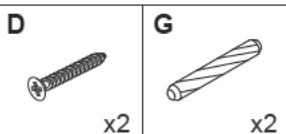
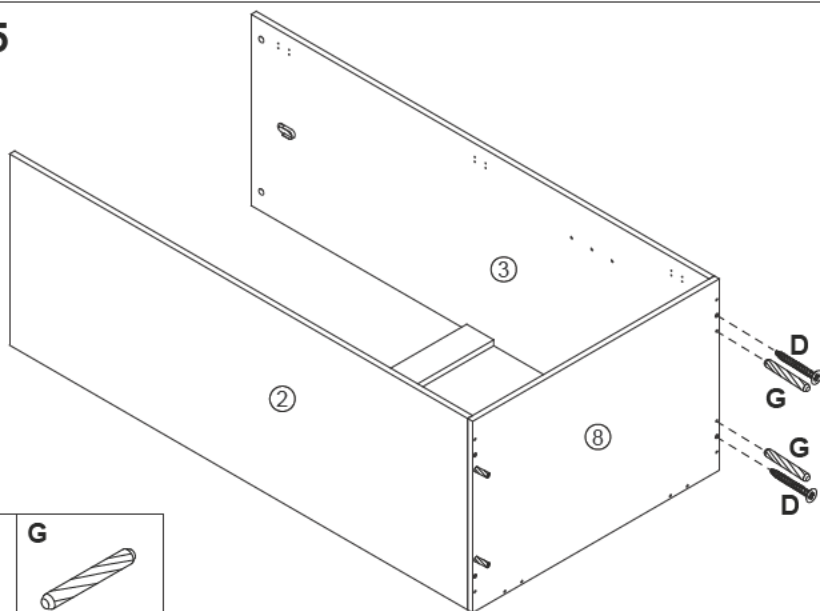



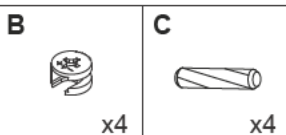
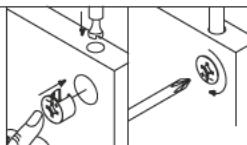
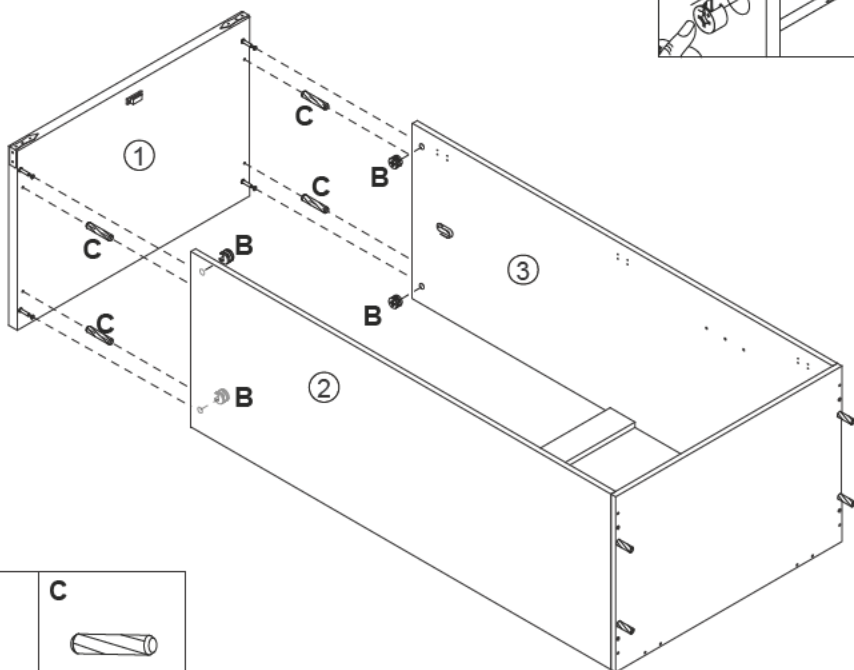

Step 6

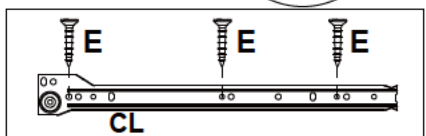
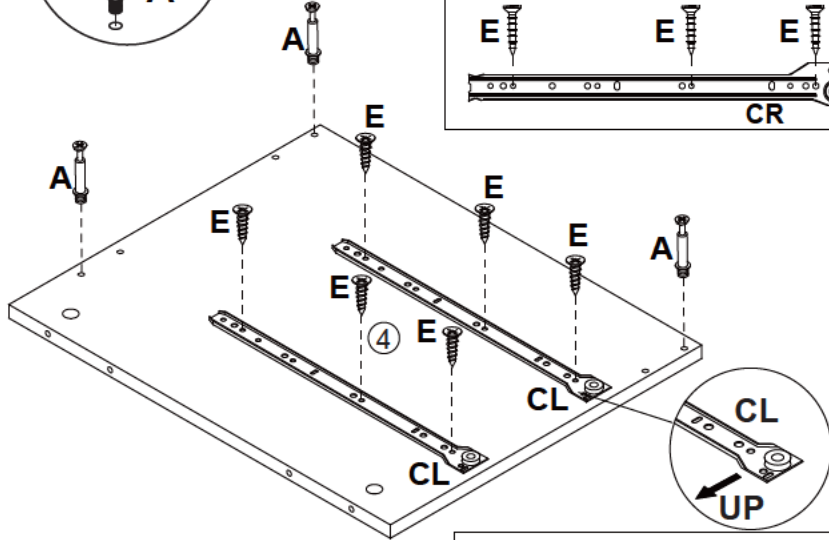
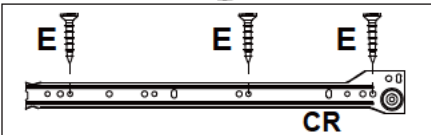
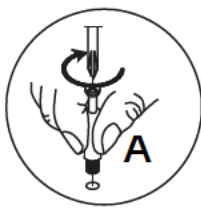
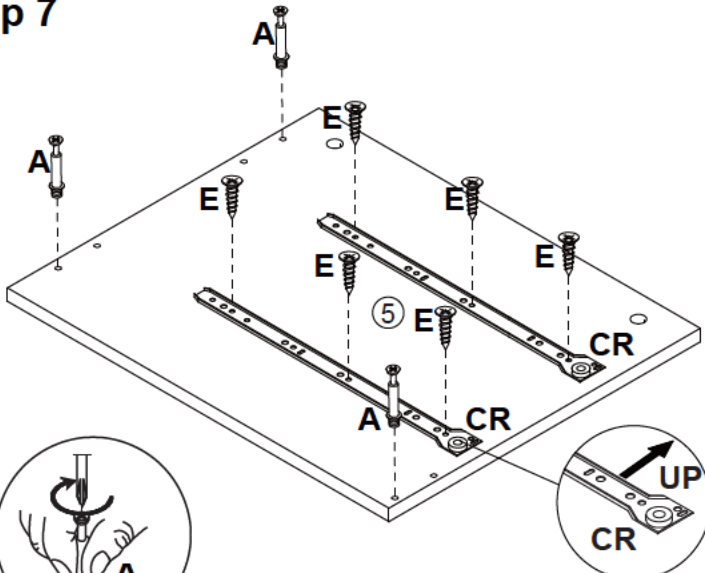
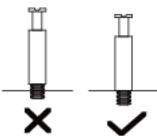

Step 7



A  x6	E  x12	CL  x2	CR  x2
---	--	--	---

Step 8

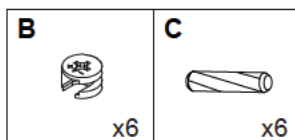
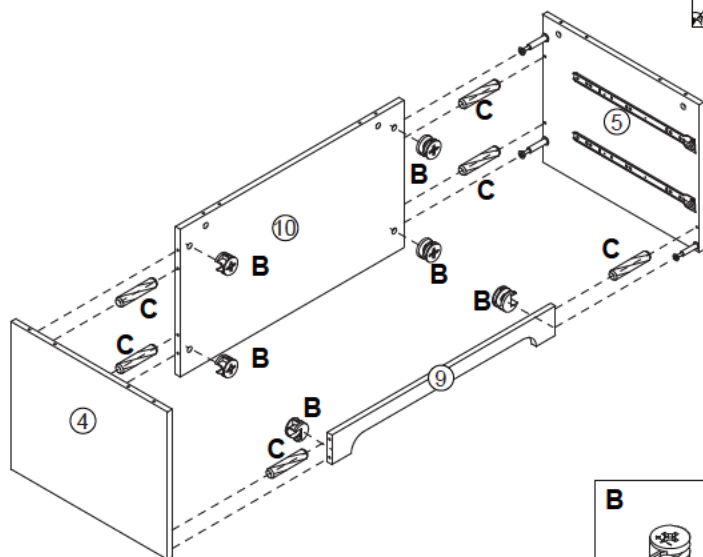

Step 9

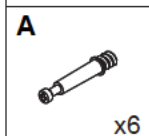
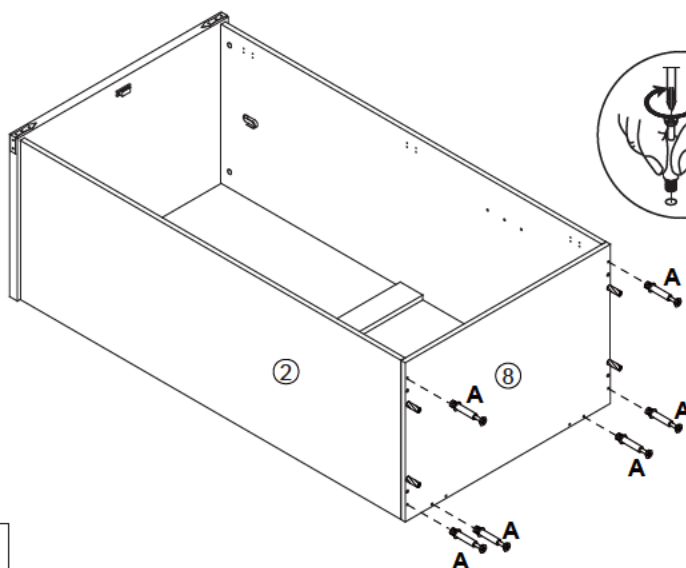

Step 10

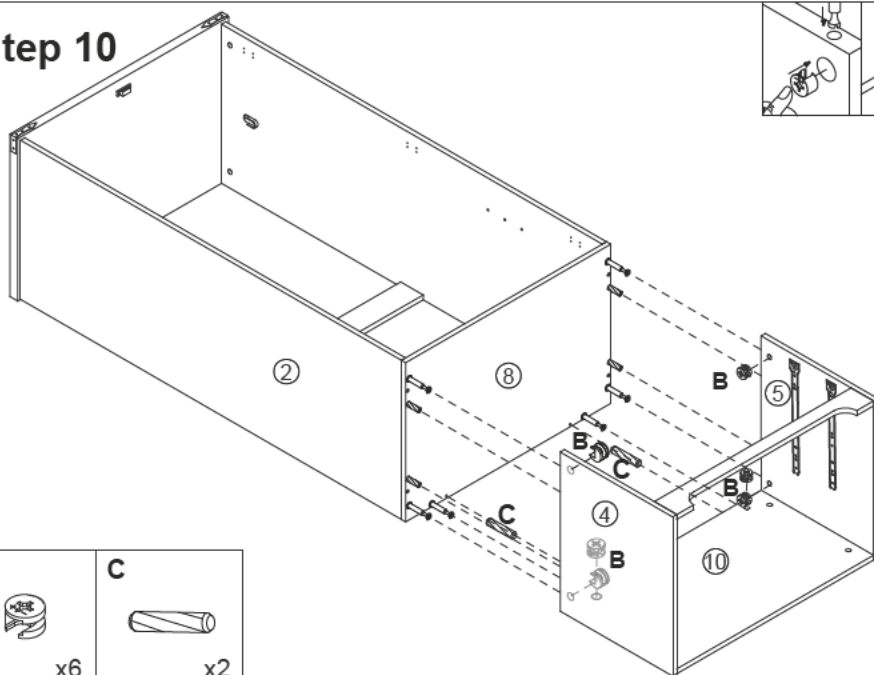

B



x6

C



x2

Step 11

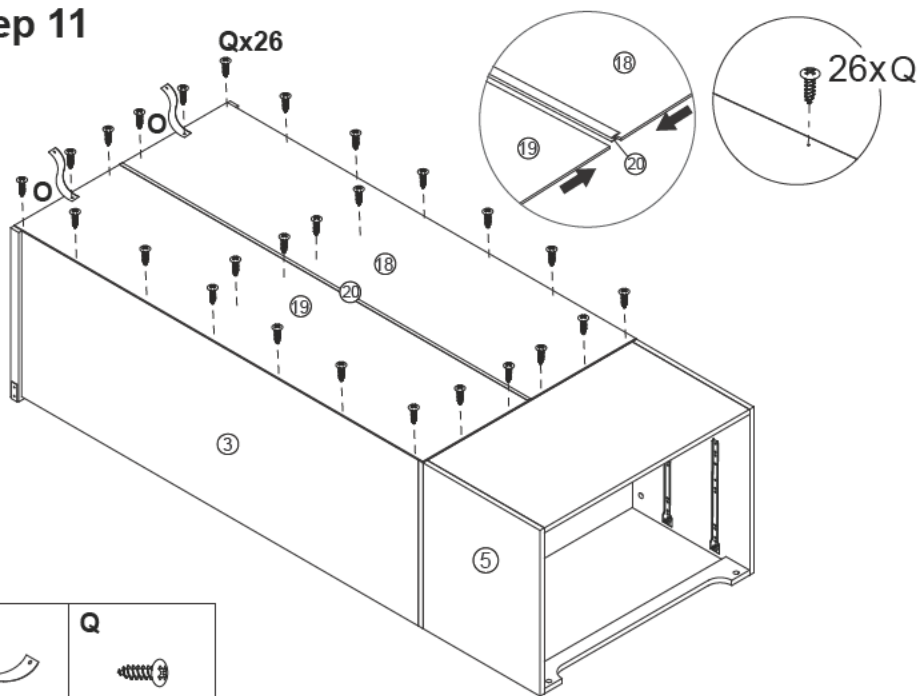

O



x2



Q



x26

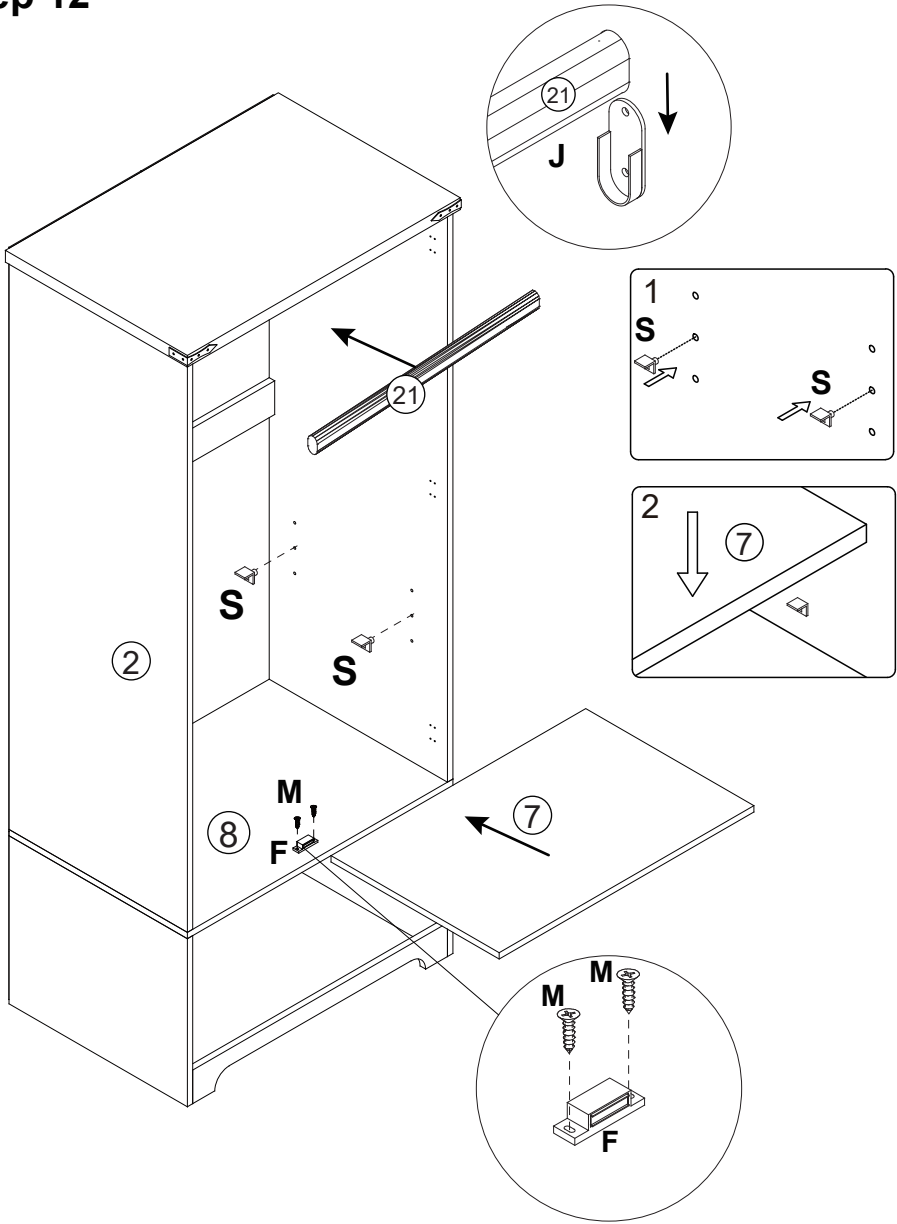





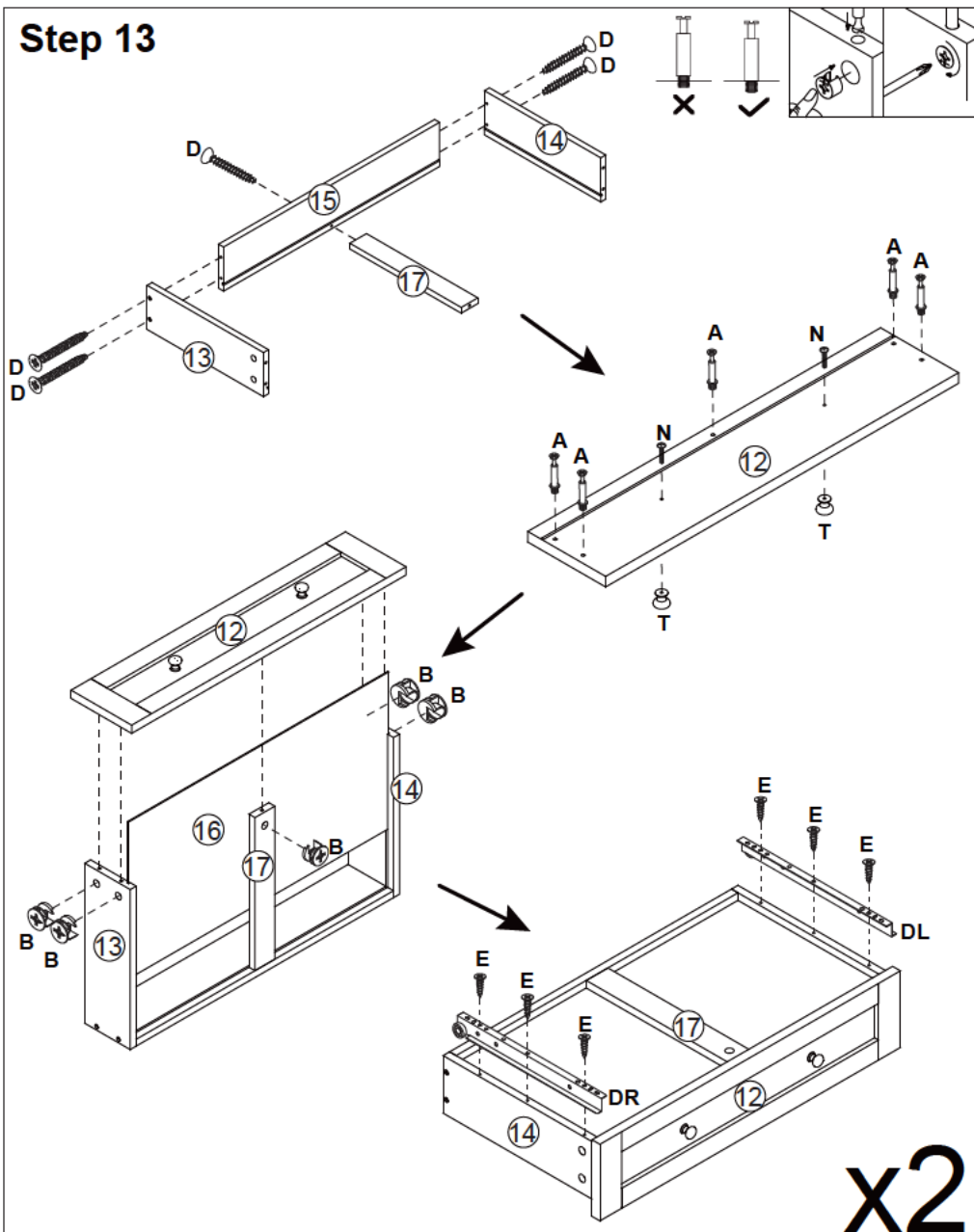

Step 12



M  x2	F  x1	S  x4
---	---	--







Step 13

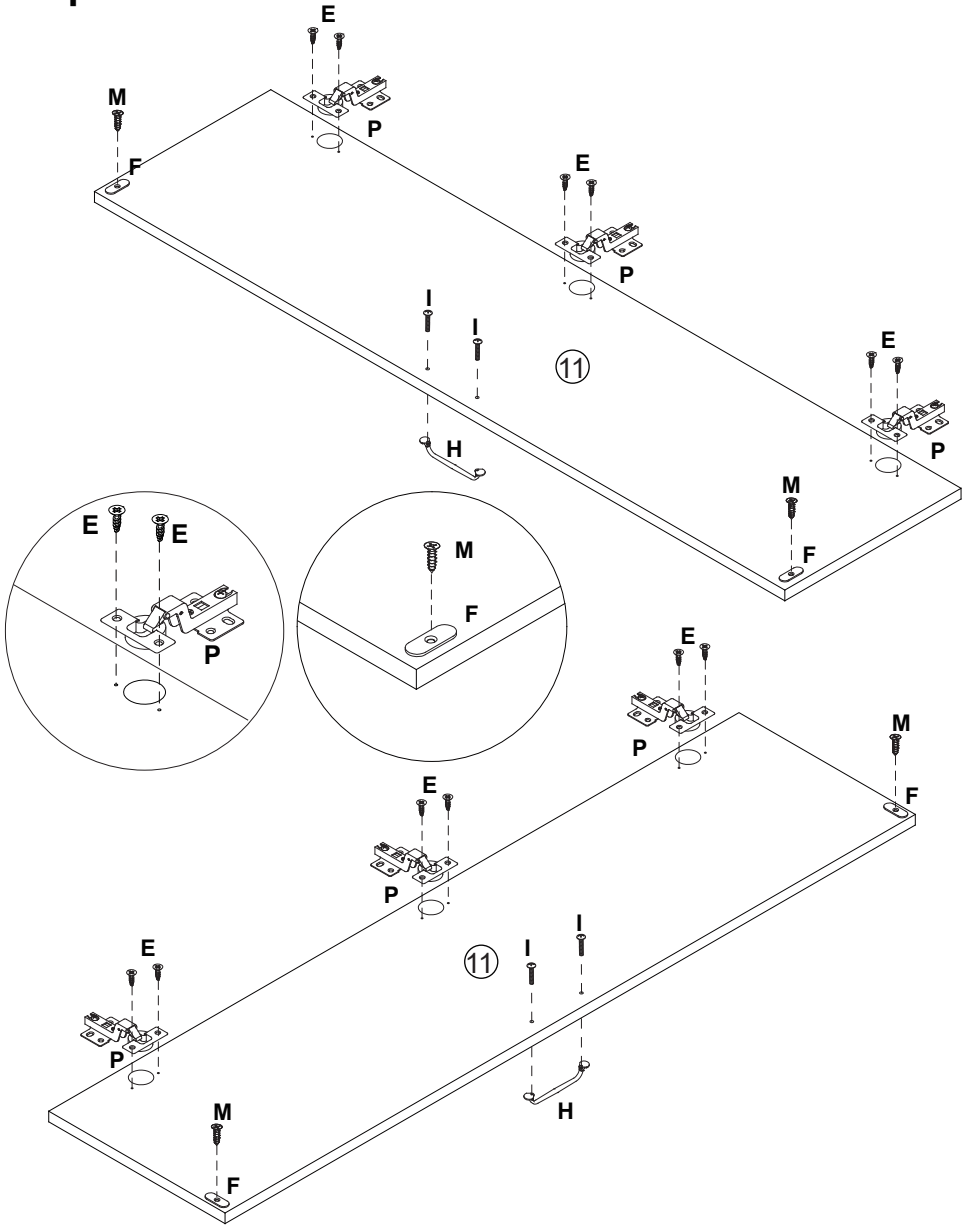

A  x10	B  x10	D  x10	E  x12	N  x4	T  x4	DL  x2	DR  x2
---	--	--	--	---	---	--	---

Step 14



<p>E</p>  <p>x12</p>	<p>M</p>  <p>x4</p>	<p>F</p>  <p>x2</p>	<p>H</p>  <p>x2</p>	<p>I</p>  <p>x4</p>	<p>P</p>  <p>x6</p>
--	---	---	---	---	--

Step 15

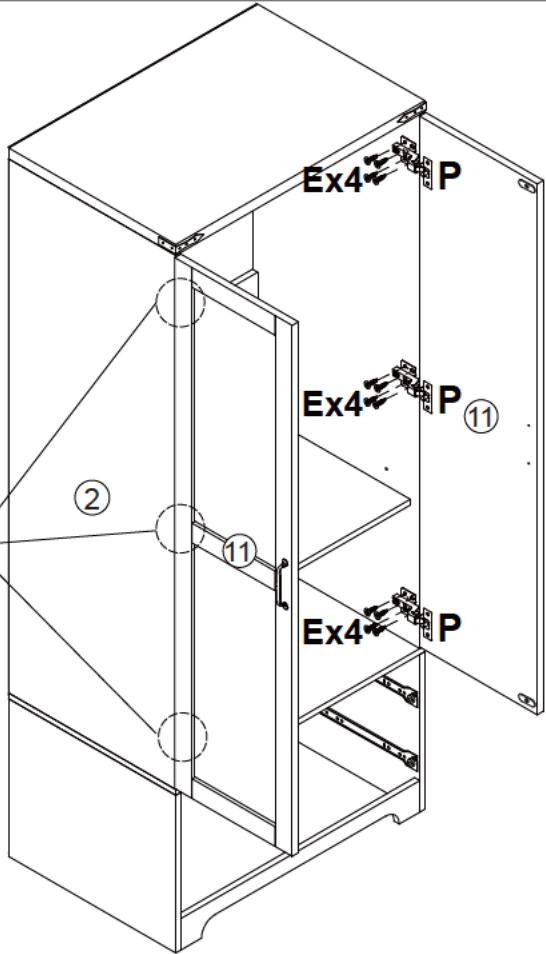
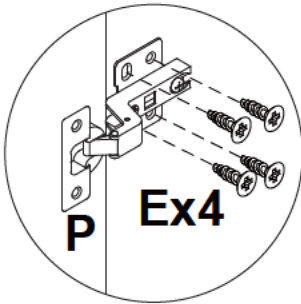
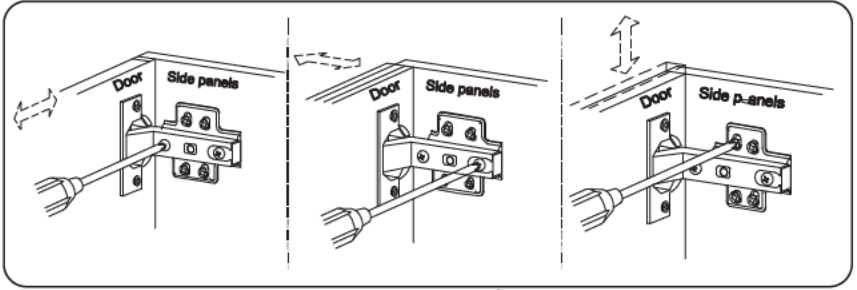



E

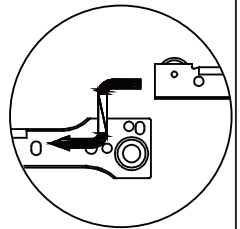
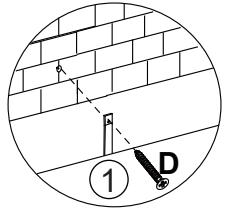
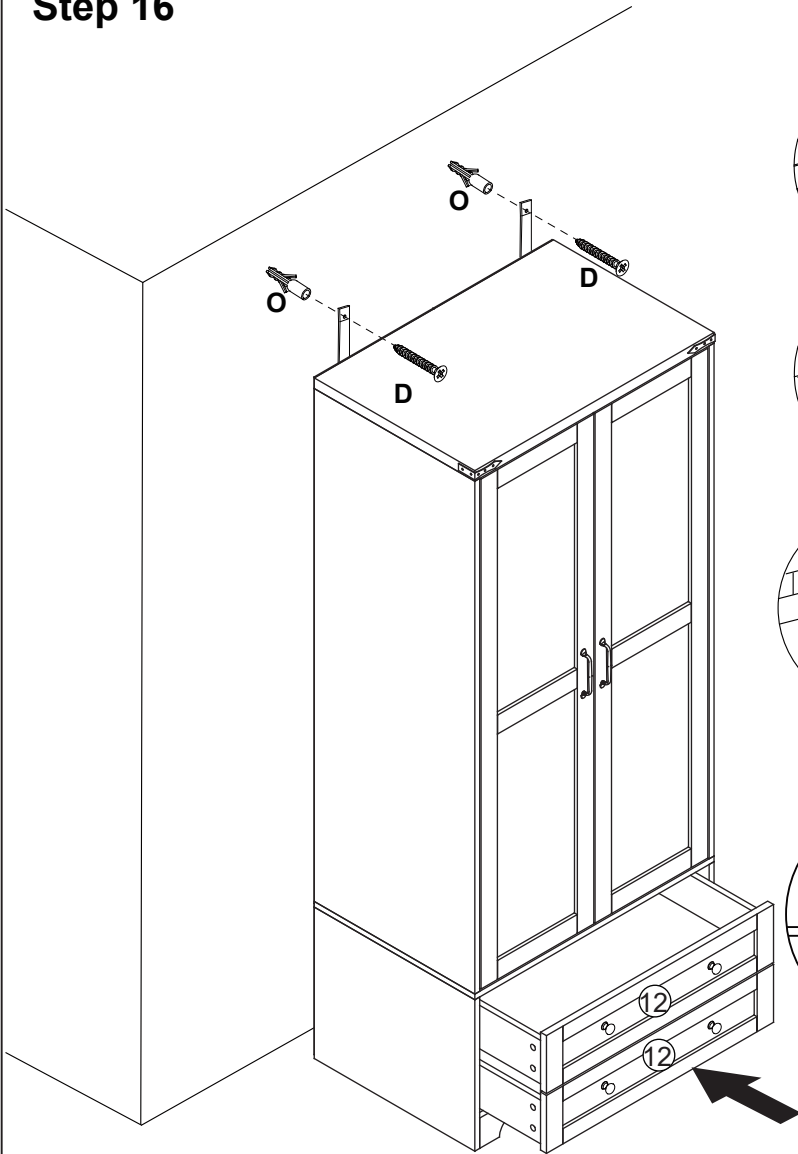

x24

Step 16

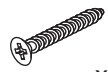

D  x2	O  x2
---	--

Before



After

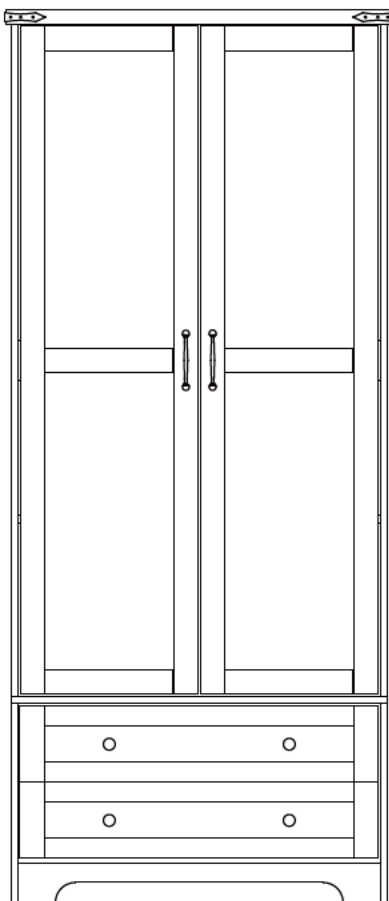

Installation tips: If the height of the door is inconsistent after installation, please Hinge adjustment.

Hinge adjustment

To facilitate the adjustment, install the E1 screw first, and then install the E2 screw.

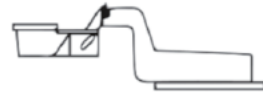
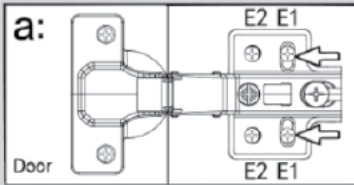

Great bend



Middle curve



Straight arm

Hinge adjustment

a: To move doors up or down: loosen screws shown and move doors to suit.

Once doors are aligned, re-tighten Screws H

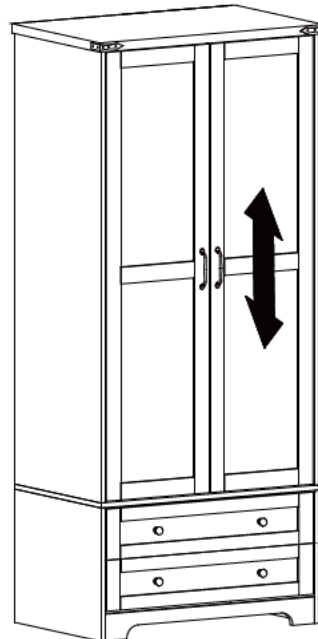
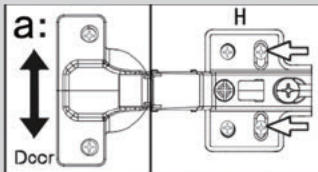

Hinge adjustment

b: To move doors in or out: loosen screw shown and move doors to suit.

Re-tighten screws

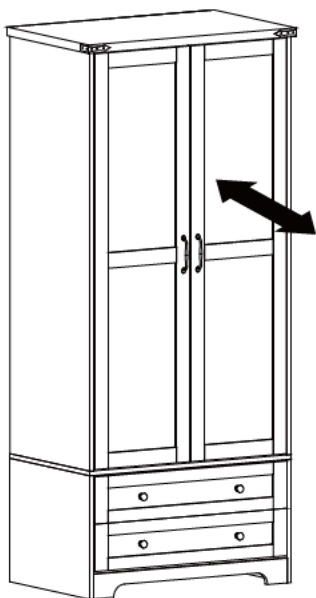
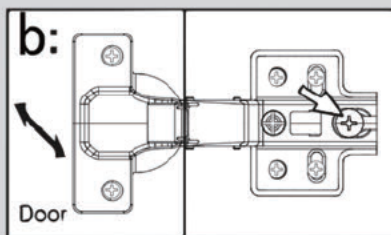

Hinge adjustment

c: To move doors left or right: loosen screw shown and move doors to suit.

Re-tighten screws

