

Jack Stonehouse



Ceiling Fan Light Manual

Important safety instructions

Please read and understand this manual before attempting assembly. Ensure you have all parts required, as featured in the packaging contents table before you begin installation.

If you have any questions, please refer to contact information on the back page.

CAUTION: To avoid possible electric shock, make sure the power supply and circuit breaker box is shut off before wiring.





- Consult a qualified electrician, to ensure that all is installed correctly and safely, if unsure on any part of the installation.
- The ceiling fan light mounting carrier can support up to 66lbs (30kg).
- Mount the lowest moving parts at least 7.5ft (2.3m) above the floor or ground level.

- The fan size is 7in (20cm) and should be mounted so that the edge is at least 15in (38cm) from walls or other upright structures.

- Ensure that all electrical connections are sealed with appropriate connectors and electrical tape in the outlet box.



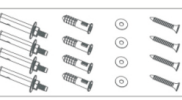

- All set screws must be checked and re-tightened, if necessary, before operating the ceiling fan.

Package contents

| | | |
|--|--|--|
|  A |  B |  C |
| |  D |  E |

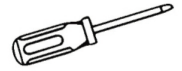
- A. Ceiling fan light
- B. Remote control wall
- C. Infra-Red remote control
- D. S-hook
- E. Screw accessories

Not included but required for installation.

| | |
|-------------------------|---|
| Philips(P1) Screwdriver |  |
| Wire-stripping Pliers |  |
| Step ladder |  |
| Electrical Tape |  |

Mounting options

Wooden ceiling

If you have a wooden ceiling, use wood screws with a plastic expansion anchor.

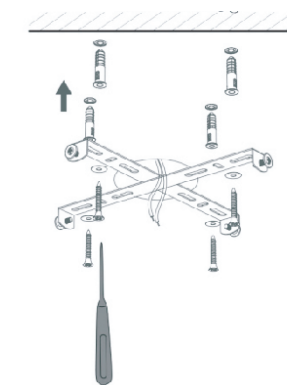

Concrete ceiling

For a concrete ceiling, use screws with lock washers.

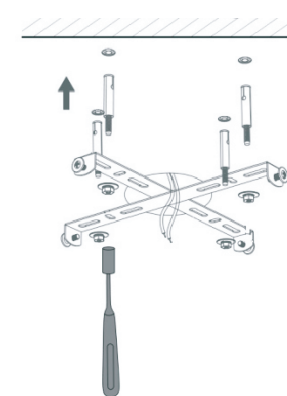

Installation

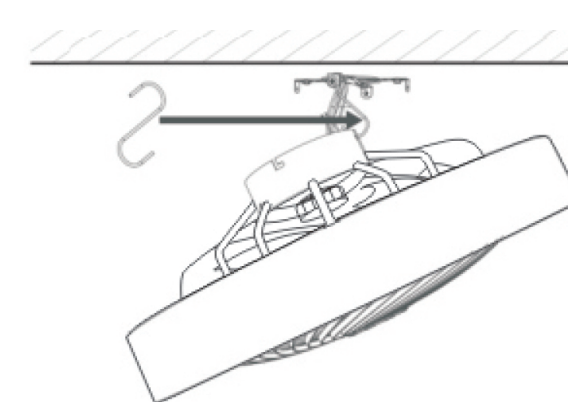

Step 1) Install mount as per previous suitable mounting option in your desired location.

Step 2) Use the auxiliary mounting tool S-hook to hang the ceiling fan.

Step 3) Wiring: Refer to the full safety instructions before proceeding.

- I. Connect the black live wire (marked L) on the receiver to the live wire (typically black) on the outlet box.
- II. Connect the white neutral wire (marked N) on the receiver to the neutral wire (typically white) on the outlet box.
- III. Connect the earth wire (bare wire) from the base of the ceiling fan, with the earth wire (bare wire) of the outlet box.

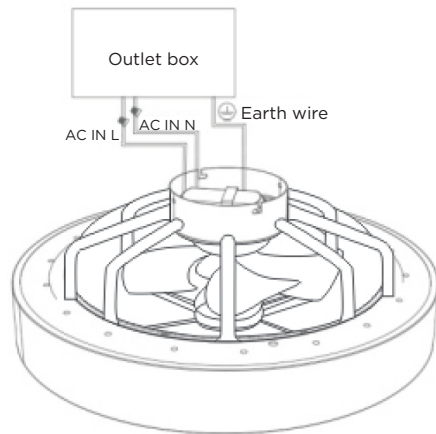

Step 4) Remove the S-Hook and clip the 7-shaped hole of the ceiling fan light holder onto the cross-hanging mounted plate.

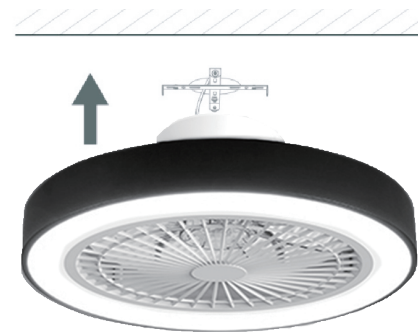

Step 5) Insert the 4 holding screws to secure.



Remote control operation

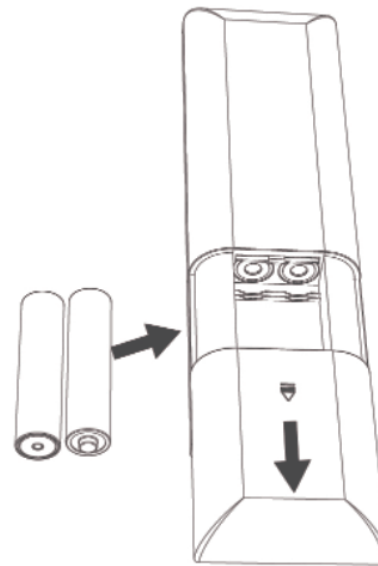

- Light ON/OFF
- Light & Fan off
- Colour Temperature Switch
- Small Night Light
- Click or long press this button to enhance the brightness
- Click or long press this button to weaken the brightness
- Long press this button to increase color temperature
- Long press this button to decrease color temperature
- Fan clockwise rotate
- Fan Anti-clockwise rotate
- Turn off automatically after 2-hour countdown
- Turn off automatically after 1-hour countdown
- Fan speed, 1 is the lowest, 6 is the highest
- Turn off fan

Maintenance

Note connections may become loose due to the natural movements of the fan. Check the support connections, brackets, and blades twice a year, to ensure they are safe.

- Dust the fan regularly with a soft, clean, dry cloth.
- Do not use harsh cleaners or materials as these may damage the device.
- Prevent bending blades during the cleaning process by sporting the pressure when wiping.
- Keep the ceiling fan and blades clear of water as this could cause fire or electric shock.

| | | | |
|----------------------|---------------------|------------------------------|------------------------|
| Product Name | Ceiling Fan Light | Product Size | 48.8*20cm |
| Iten numer | XM-164 | Power | Fan: 30w Light: 40w |
| Input Voltage | 220-240v | Valid Remote Distance | 10m |
| Battery type | 2*AAA(not included) | Rotating Speed(rpm) | 1200r/mim |
| Reversible | Yes | Fan Timing | 1h / 2h |

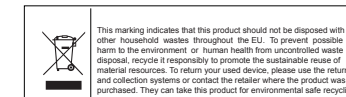

For futher information, additional parts, accessories or other queries please contact:



01604 537900



35 Tameside Drive,
Birmingham,
B35 7AG



sales@jackstonehouse.com



www.jackstonehouse.com

FOLLOW US



@Jackstonehouseuk

Jack Stonehouse