

## Rectangular Mirror Assembly & Care Instructions

---

### 28 Inch Rectangular Mirror

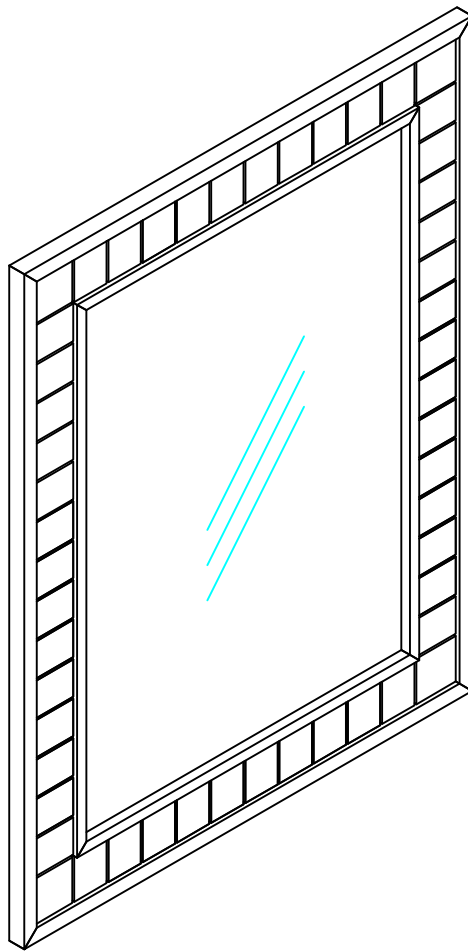

Before you begin:

Please review all your packing materials carefully before discarding.

Some assembly parts may be packaged separately.



Confirm you have all the parts required for assembly and installation of this mirror before discarding the packing materials.

Carton Contents are shown on the top of Page 2.

## Carton Contents:

- A) Mirror
- B) Hardware Bag
- C) Four hangers (Pre-installed on the back of the mirror)

## PACKAGE CONTENTS

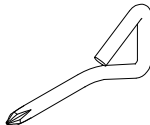
Part	Name Details	Picture	Amount
A	Plastic Anchor		2
B	Screw #4 * 60mm		2
C	Triangle Screwdriver Ø5 x 3"		1

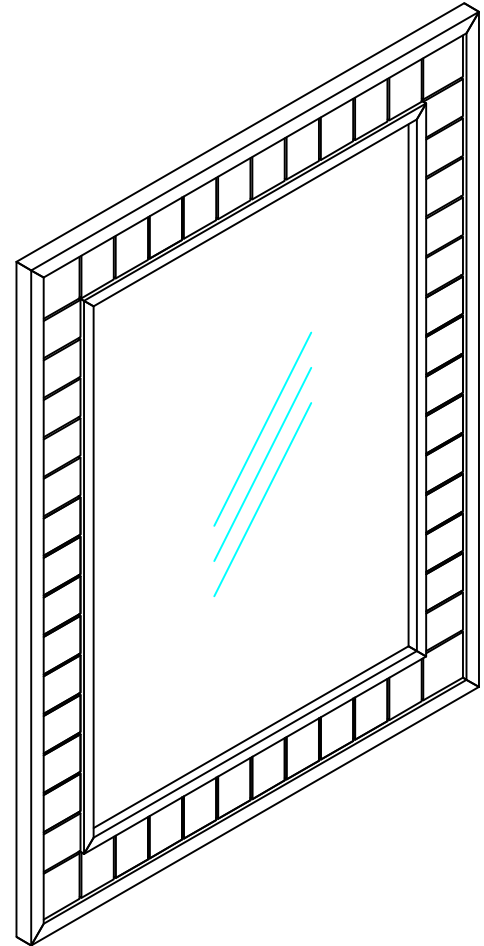

## Pre-Installation - Review:

Confirm the installation location of this mirror is clear of obstructions

Recommended Tools and Equipment pictured below



Safety goggles.



Level

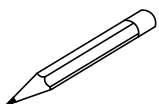

Pencil



Clean rag

## Manufactures Note:

Brio Bathworks recommends you always consult with professional installers and contractors regarding the correct installation of this mirror.

Please keep this Assembly & Care Guide for future reference.

## Installation

---

1. Measure the distance between the two hangers. Locate the position of the mirror on the wall and draw a horizontal line on the wall at your desired height, mark the positions with a pencil on the horizontal line.

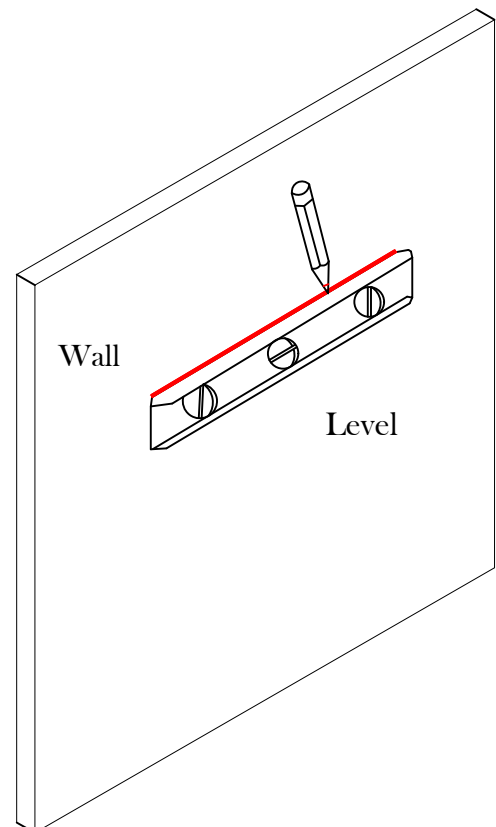
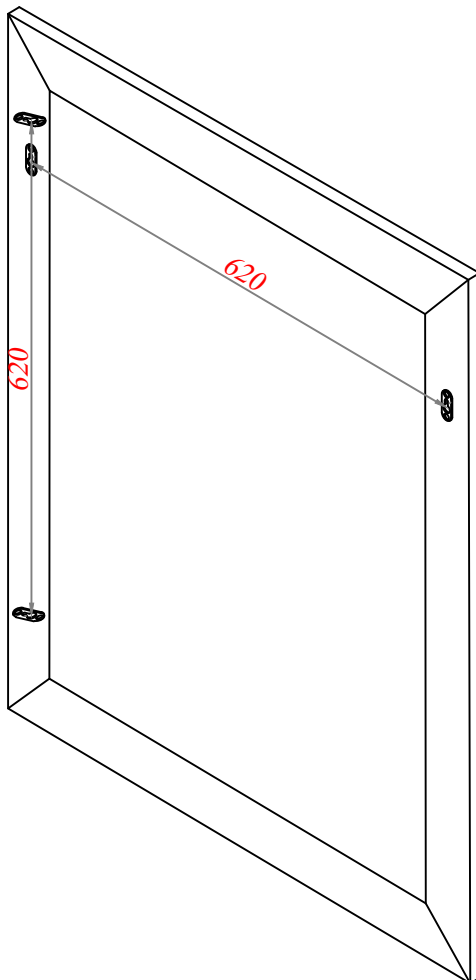

# Installation

2. Drill holes in the positions and insert plastic anchors (A), insert the screws (B) into the plastic anchors (A).

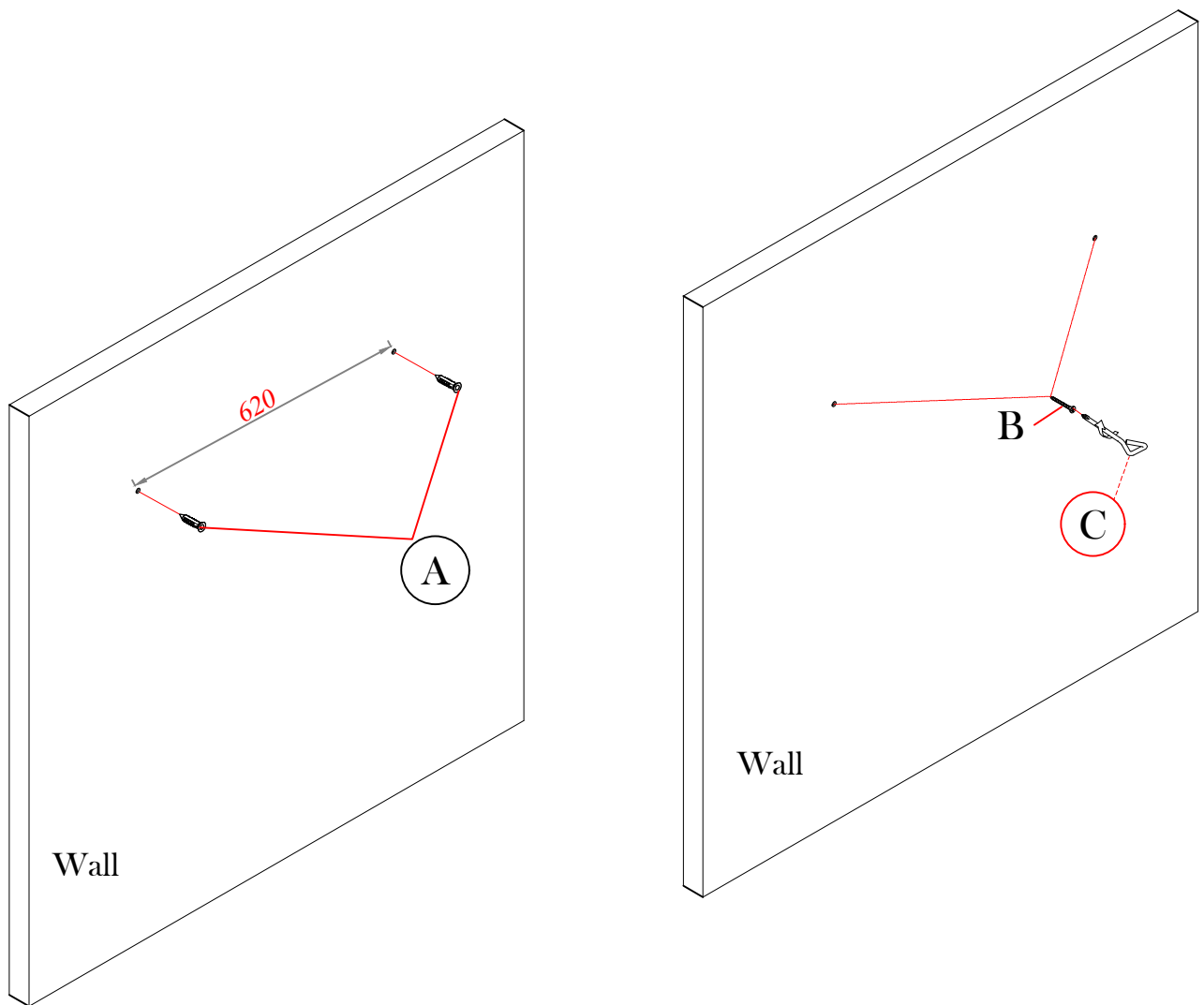

# Installation

3. Hang the mirror to the screws (B), align the screws with the hangers and insert the heads of screws into the hangers.

