

BEACH TENT

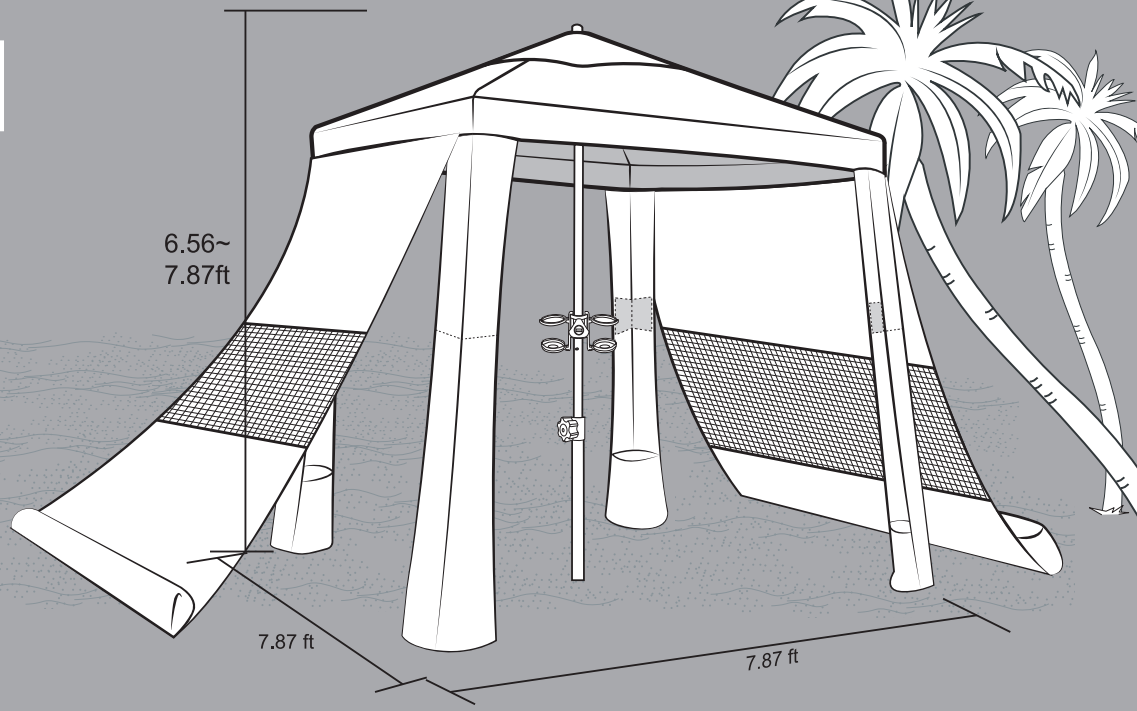

! :
User Manual



CAUTIONS

- Never erect on steep slopes.
- Never use in severe conditions, e.g., heavy rain, storm, strong wind and thunderstorm.
- Never place any flame source in or near your tent . Never use, or light or refuel a heat source inside your tent .
- Carefully consider the possibility of lightning strikes, strong winds, and other objective hazards when choosing a site to reduce the risk of loss or injury to the tent or occupants.

IN THE BOX



- Check if all accessories are included. Contact us via if there is any part missing or damaged.
- There might be some differences in accessories due to different product batches, the accessories actually received shall in kind prevail.

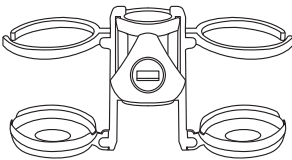

Foldable Cup Holder *1

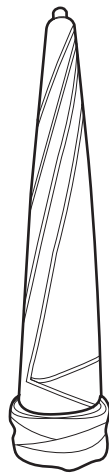

Beach Umbrella *1
(Silver Coated Oxford Fabric)

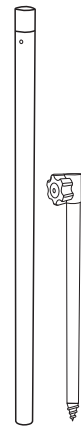

Extension Pole *2
(Aluminum)



Side Wall *2
(Oxford Fabric)

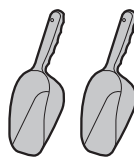

Sand Shovels *2

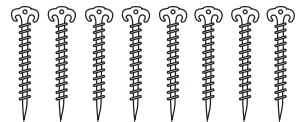

Grass Pegs *8

SETTING UP



- Take the tent down in any potentially windy or rainy weather. Avoid using in inclement weather.
- It is recommended to use the tent under low winds (wind speed not exceed 10-15mph / level 3-4).
- You can also use the tent as a patio umbrella by attaching the extension pole (diameter of 1.18in / 30mm) to a weighted umbrella base (not included).

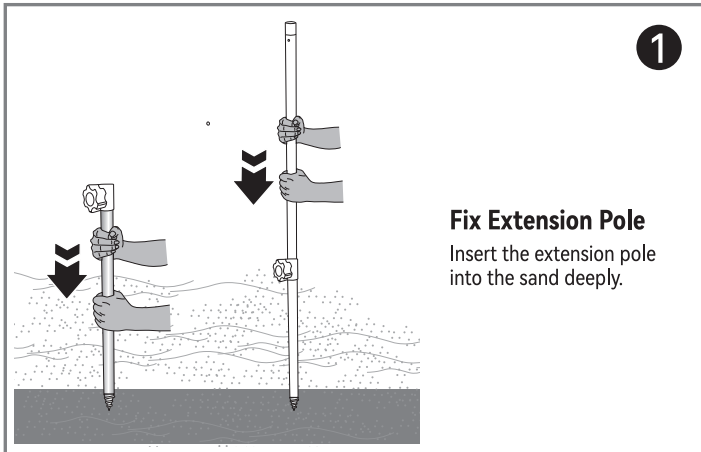

1

Fix Extension Pole
Insert the extension pole into the sand deeply.

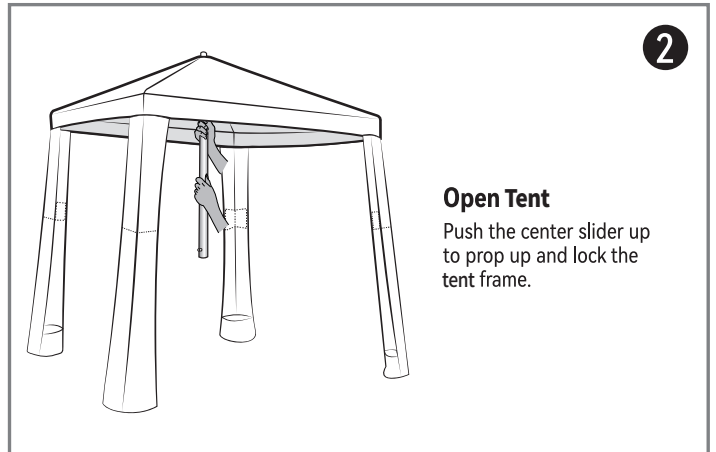

2

Open Tent
Push the center slider up to prop up and lock the tent frame.

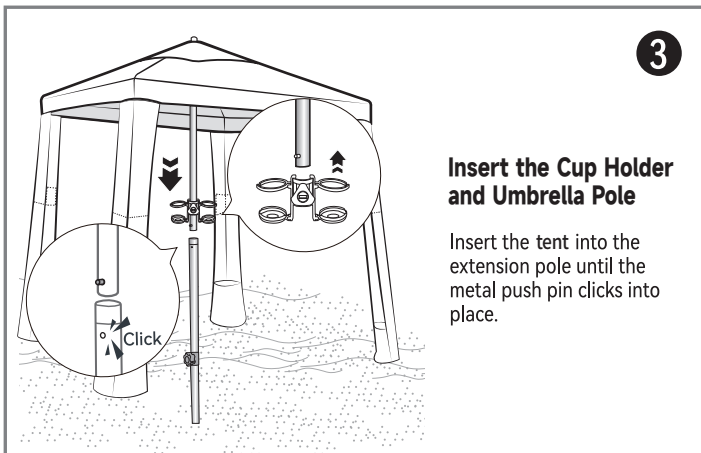

3

Insert the Cup Holder and Umbrella Pole
Insert the tent into the extension pole until the metal push pin clicks into place.

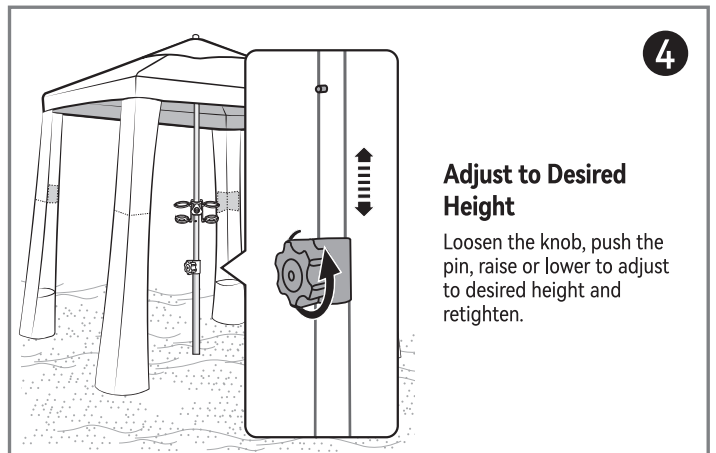

4

Adjust to Desired Height
Loosen the knob, push the pin, raise or lower to adjust to desired height and retighten.

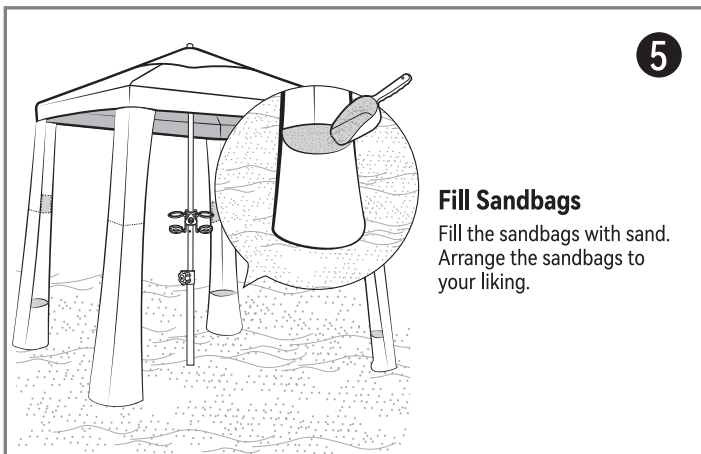

5

Fill Sandbags
Fill the sandbags with sand. Arrange the sandbags to your liking.

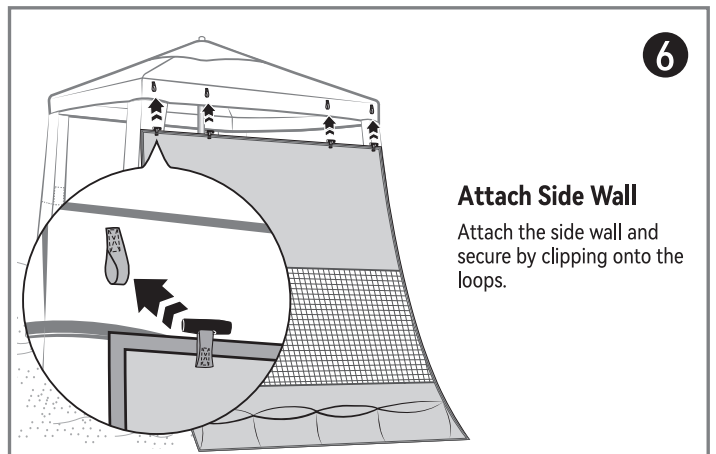

6

Attach Side Wall
Attach the side wall and secure by clipping onto the loops.

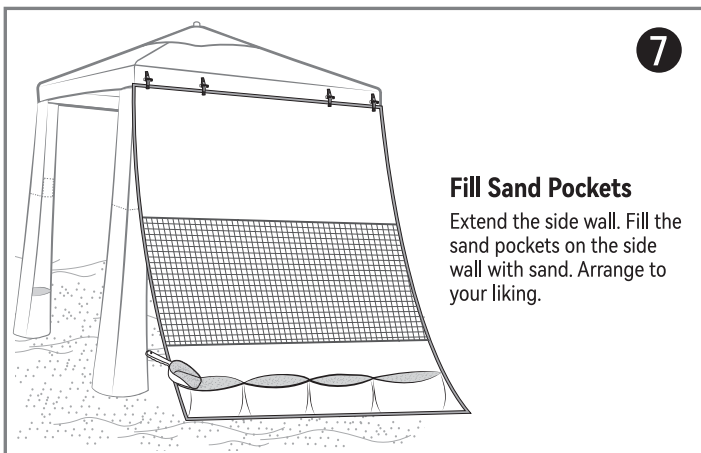

7

Fill Sand Pockets
Extend the side wall. Fill the sand pockets on the side wall with sand. Arrange to your liking.

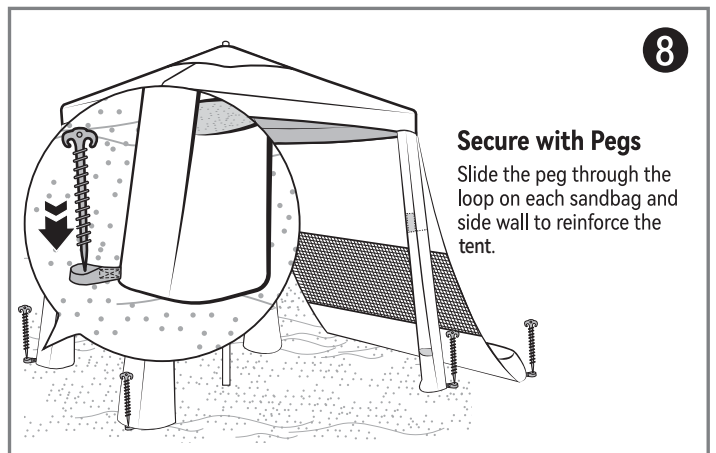

8

Secure with Pegs
Slide the peg through the loop on each sandbag and side wall to reinforce the tent.

CARE & CLEANING



- DO NOT use laundry detergent, washing machines or dryers.
- Never store, even for a short period of time, without drying it thoroughly and brushing off caked dirt.

- 1 While the tent is set up, simply brush off any visible dirt or debris.
- 2 Use a soft, non-abrasive brush to sweep away any remaining dirt and grime. Take the side wall down. Give it a rinse of clean water, then spot clean with a mild soap and a soft sponge.
- 3 Let the tent dry completely before closing or storing to avoid mildew. Store inside the carry bag in a cool, dry space.

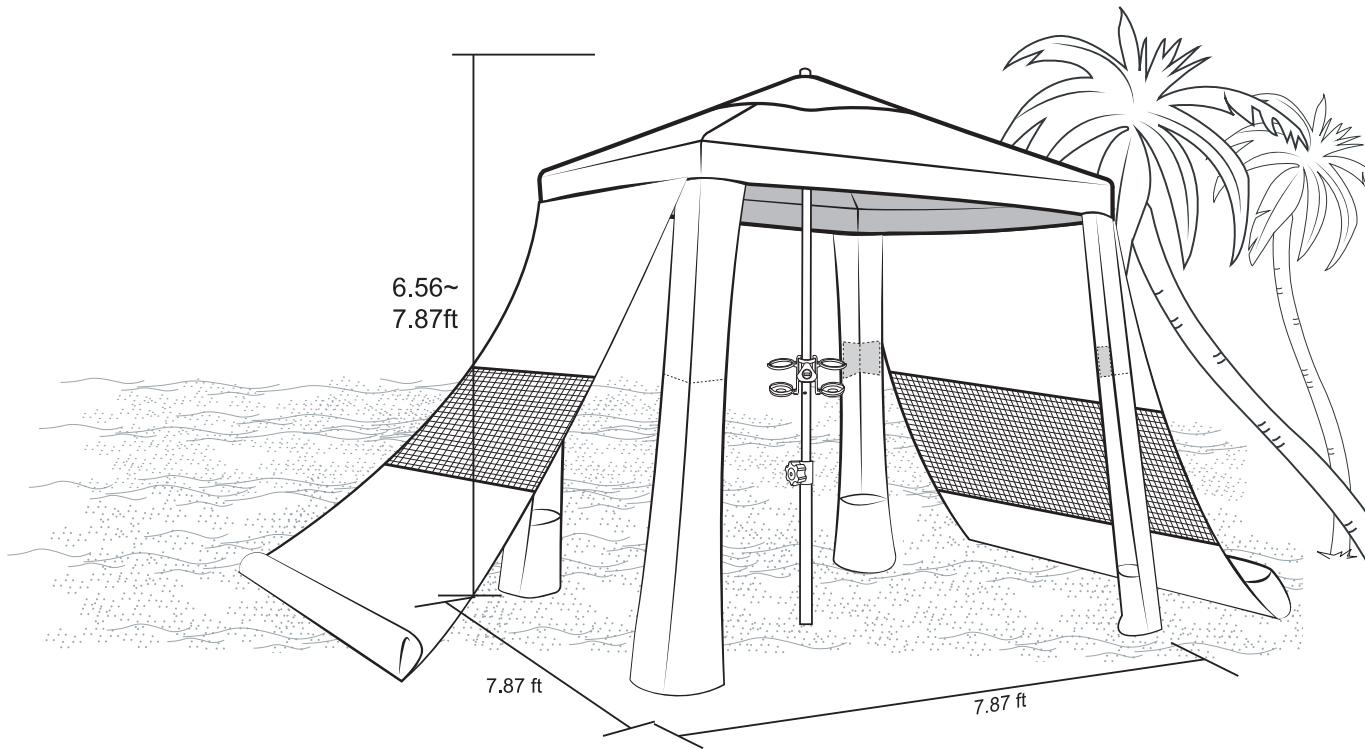

CAUTIONS

- Ne jamais installer sur des pentes raides.
- Ne jamais utiliser par conditions sévères (pluie torrentielle, tempête, vent violent, orage).
- Ne placez aucune source de flamme dans ou près de la tente. N'utilisez, n'allumez ni ne rechargez jamais une source de chaleur à l'intérieur.
- Évaluez attentivement les risques de foudre, vents violents et autres dangers objectifs lors du choix de l'emplacement, afin de réduire les risques pour la tente ou ses occupants.

DANS LA BOÎTE



- Vérifiez que tous les accessoires sont inclus. Contactez-nous en cas de pièce manquante ou endommagée.
- Les accessoires peuvent varier selon les lots ; les accessoires réellement fournis prévalent.

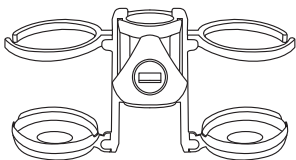

Porte-gobelet pliable*1



Parasol de plage*1
(toile Oxford argentée)

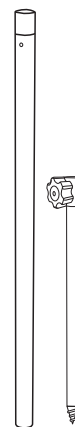

Tube d'extension*2
(aluminium)



Paroi latérale*2
(toile Oxford)

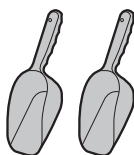

Pelles à sable*2

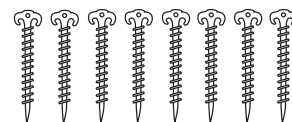

Piquets à herbe*8

MONTAGE



- Démontez la tente en cas de vent ou pluie potentiels. Évitez toute utilisation par mauvais temps.
- Il est recommandé d'utiliser la tente par vent faible (vitesse $\leq 10-15$ mph / niveau 3-4).
- Elle peut aussi servir de parasol en fixant le tube d'extension (diamètre 30 mm) sur un socle lesté (non inclus).

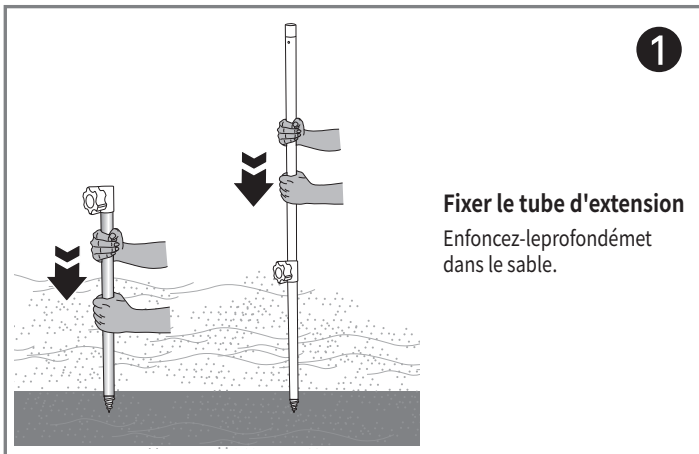

1

Fixer le tube d'extension
Enfoncez-le profondément dans le sable.

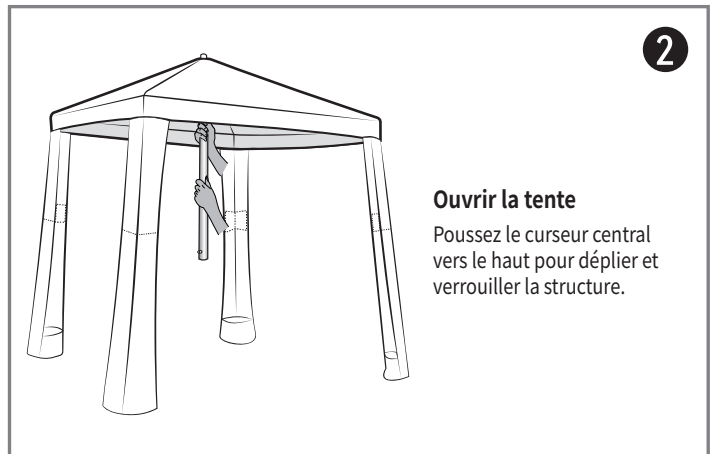

2

Ouvrir la tente
Poussez le curseur central vers le haut pour déplier et verrouiller la structure.

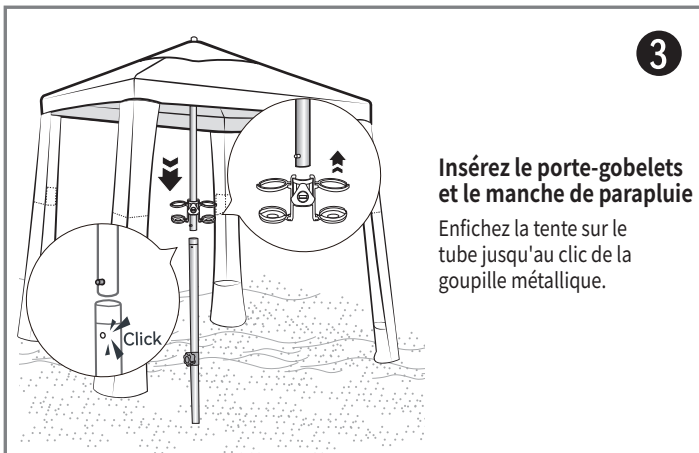

3

Insérez le porte-gobelets et le manche de parapluie
Enfichez la tente sur le tube jusqu'au clic de la goupille métallique.

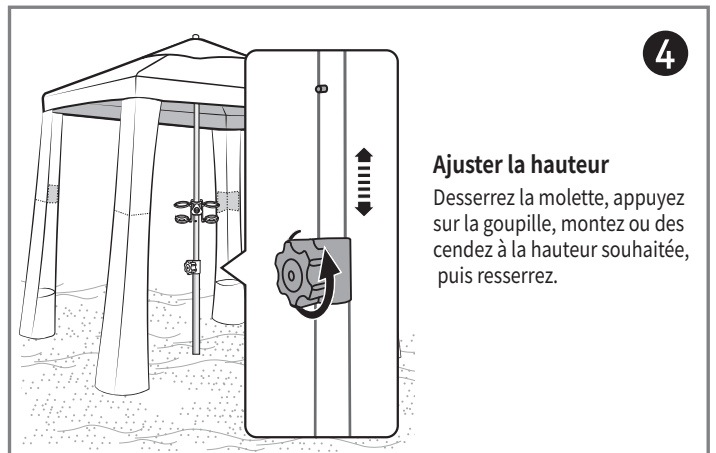

4

Ajuster la hauteur
Desserrez la molette, appuyez sur la goupille, montez ou descendez à la hauteur souhaitée, puis resserrez.

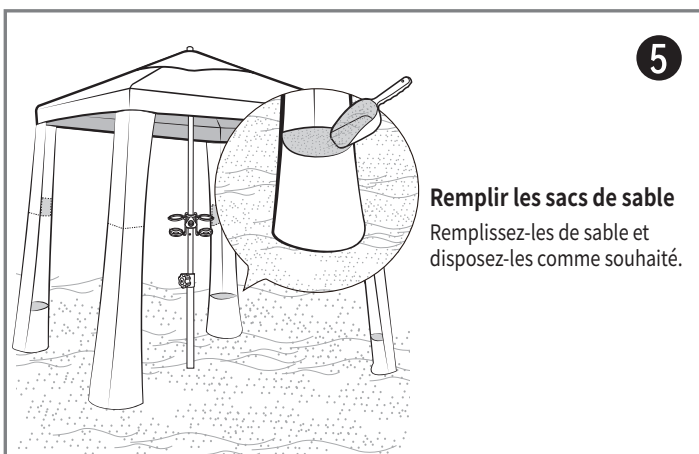

5

Remplir les sacs de sable
Remplissez-les de sable et disposez-les comme souhaité.

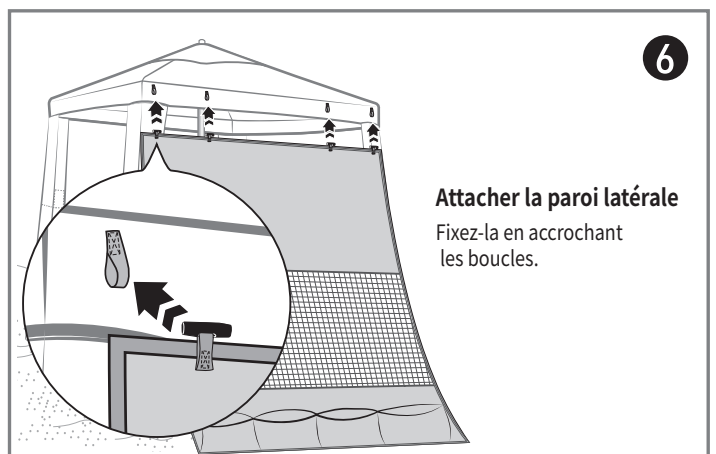

6

Attacher la paroi latérale
Fixez-la en accrochant les boucles.

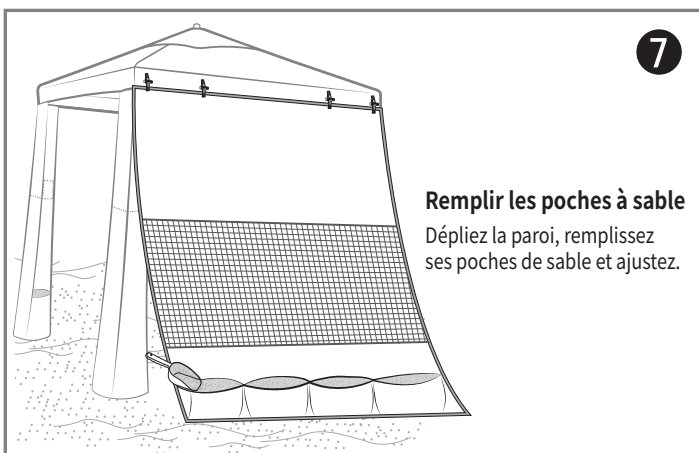

7

Remplir les poches à sable
Dépliez la paroi, remplissez ses poches de sable et ajustez.

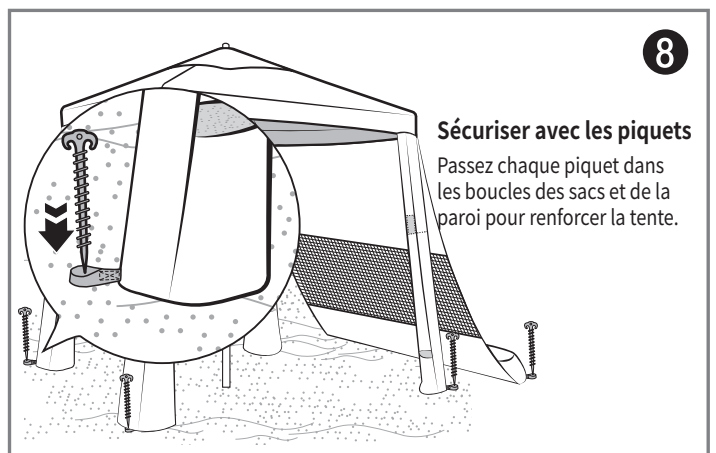

8

Sécuriser avec les piquets
Passez chaque piquet dans les boucles des sacs et de la paroi pour renforcer la tente.

ENTRETIEN & NETTOYAGE



- N'utilisez pas de détergent à lessive, de machine à laver ni de sèche-linge.
- Ne rangez jamais la tente, même brièvement, sans l'avoir complètement séchée et débarrassée de la saleté incrustée.

- 1 Lorsqu'elle est montée, balayez simplement la saleté ou débris visibles.
- 2 Utilisez une brosse douce non abrasive pour éliminer les résidus. Rincez à l'eau claire, puis nettoyez localement avec un savon doux et une éponge souple.
- 3 Laissez sécher complètement avant de plier ou ranger pour éviter la moisissure. Rangez-la dans le sac de transport, dans un endroit frais et sec.