







**ASSEMBLY INSTRUCTIONS &  
PARTS IDENTIFICATION  
56" UPHOLSTERED BENCH  
WITH METAL STRETCHER**

Thank you for purchasing this quality product. Be sure to check all packing material carefully for small parts that may have come loose inside the carton during shipment.

Parts key				Hardware kit			
No	Qty	Description	No	Description		Qty	
1	1 pc	Bench Seat	A	 Bolt	M8 x 40	8 pcs	
2	2 pcs	Leg Assembly	B	 Lock washer	M8	8 pcs	
3	1 pc	Stretcher	C	 Flat washer	M8 x 18	8 pcs	
4	4 pcs	Floor Glide	D	 Allen Key	K4	1 pc	
			E	 Big hex nut	M18	2 pcs	
			F	 Large flat washer	Ø35	2 pcs	
			G	 Key Wrench	K27	1 pc	

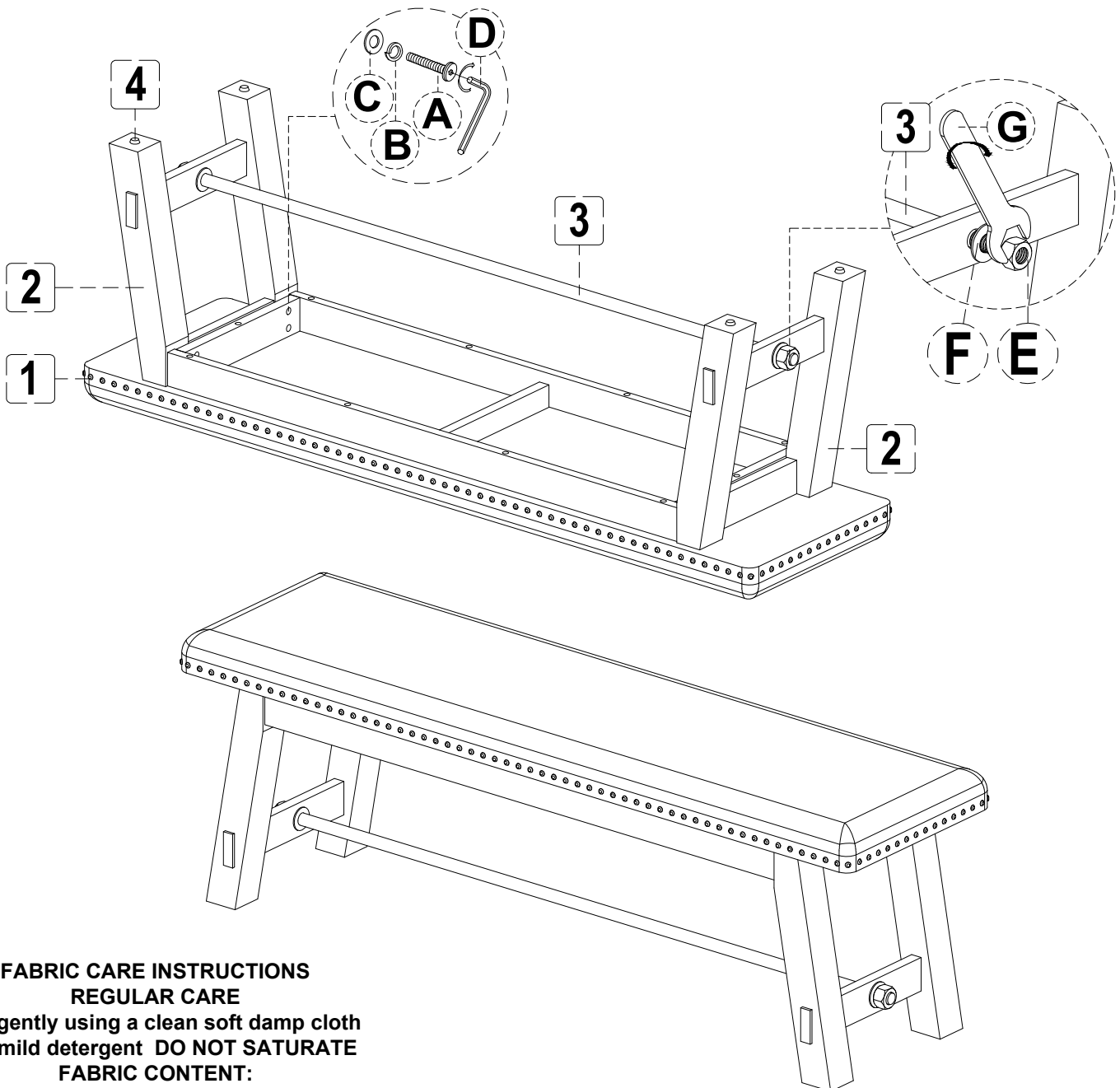

**FABRIC CARE INSTRUCTIONS  
REGULAR CARE**

Blot gently using a clean soft damp cloth  
and mild detergent **DO NOT SATURATE**

**FABRIC CONTENT:**

**100% Polyester - Cleaning code W**