

Assembly Instructions

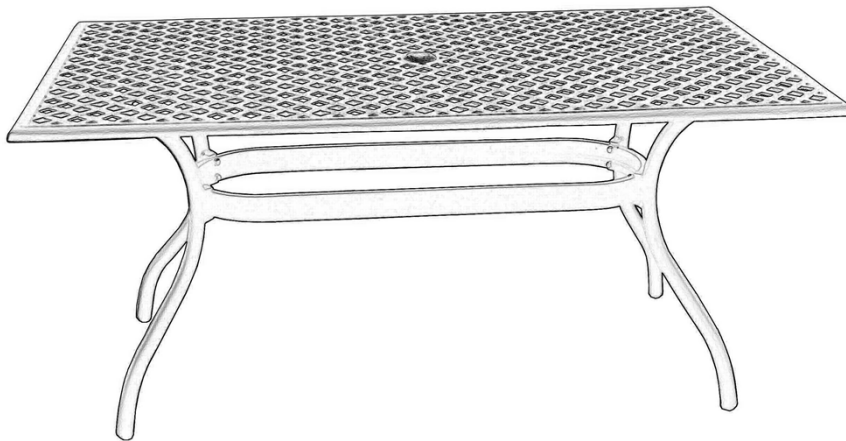

Caution : You must read this before you proceed

RECTANGULAR TABLE





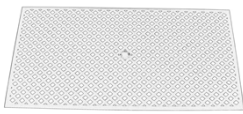

CAUTION : This table is NOT a TOY.
Keep your child / children at bay during the assembly process.

Parts List

Label	Picture	Description	QTY
A		Table Top	1
B		Table Leg	4
C		Central Support Ring	1

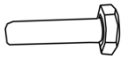
Hardware

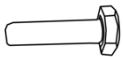
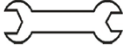
Label	Picture	Description	QTY
H		Washers(8mm)	8
		Spring Washers(8mm)	8
		Hex Bolt (30mm)	8
I		Washers(8mm)	8
		Spring Washers(8mm)	8
		Hex Bolt (25mm)	8
J		Spanner	1

Assembly Preparation

Before Beginning Assembly:

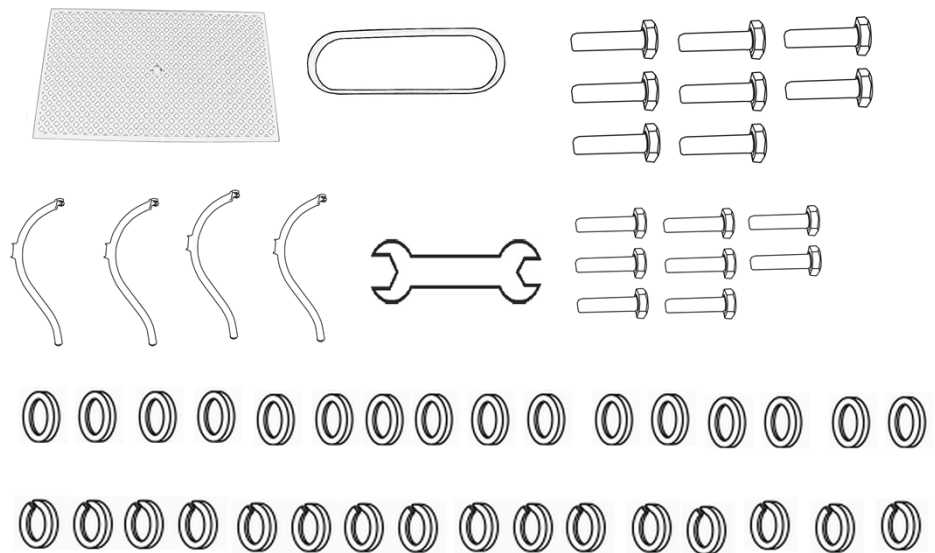

- Read instructions, cover to cover-



- Have 2 adults on hand for assembly-



- Do not assemble on flooring or carpet-



- Assemble on a clean non-marring surface (packing foam)-



- Save all packaging until finished-

Assembly Steps

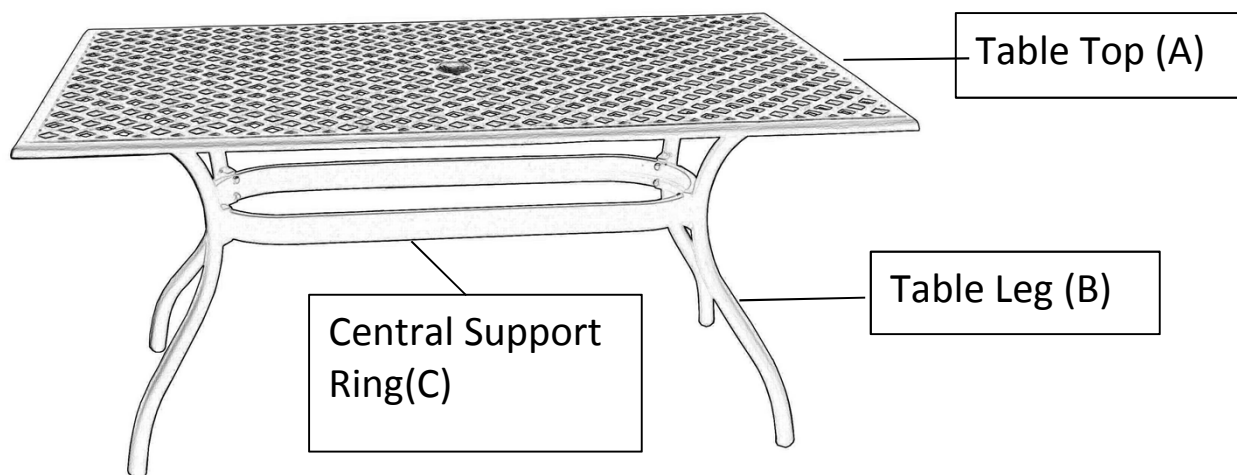

This Table has multiple parts and may require up to some 15-20 minutes to assemble. To give you an overview of the Table parts, the above picture is to help you put the various parts into perspective. Please read through the instructions herebelow to familiarise the parts and steps before assembly.

Step 1

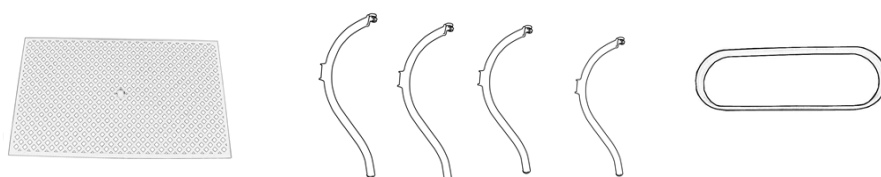

Unpack and place all parts on a clean soft surface.

Step 2

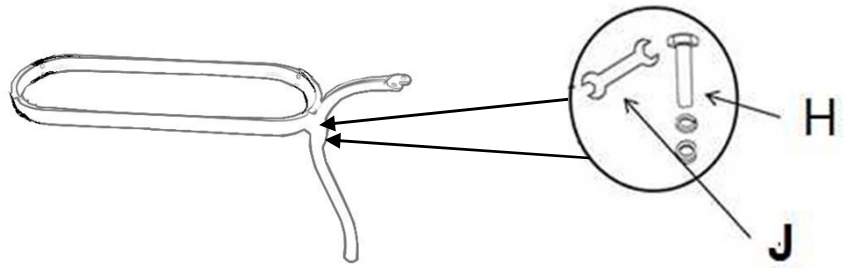

Loosely attach the Central Support Ring(C) to Table Legs(B) using washers, Spring Washers, and Hex Bolts(H), with the Spanner(J).

At this stage, only loosely tighten the Bolts.

Step 3

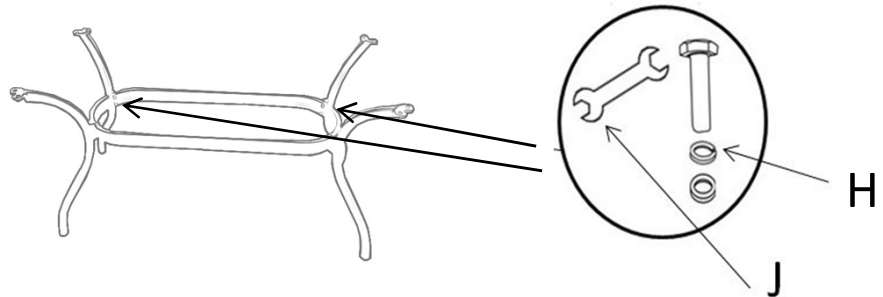

Repeat step 2, attaching the remaining 3 legs to the Central Round Support Ring(C)

At this stage, only loosely tighten the Bolts.

Step 4

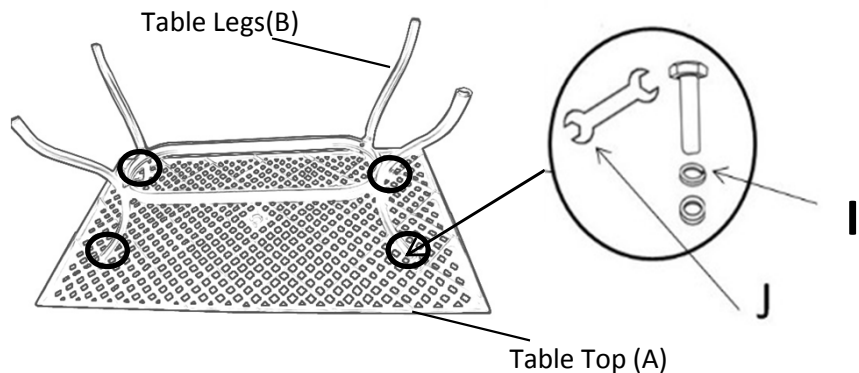

Lay the Table Top(A), top facedown onto a flat, soft, clean surface.

Attach the Table Legs(B) to the the Table Top(A) using Washers, Spring Washers, and Nuts(I) with the Spanner(J).





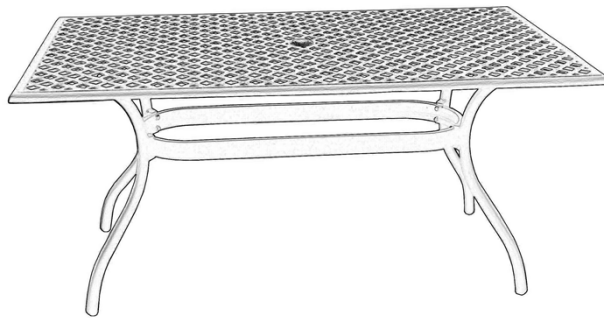



At this stage, only loosely tighten the Bolts.

Step 5



Stand the table rightside up.
In a sequential manner, proceed to tighten up all bolts.
Your table is now ready for use.

Care & Maintenance

-  Do not put hot items directly on furniture surface.
 -  Do not clean furniture with harsh cleansers or polish.
 -  To obtain the longest lifespan of your outdoor products, minimizing exposure to direct sunlight is recommended.
 -  Children should not climb or jump on the furniture.
 -  Do not write on furniture without a padded barrier to protect the surface.
 -  To obtain the longest lifespan of your outdoor products, avoid extended and lengthy exposure to rain, snow, and direct sunshine. Whenever possible cover the product and /or place under patio or awnings.
 -  Not for commercial use. For residential use only .
 -  Stains may be removed with mild soap solution and damp cloth.
-
-  Dust and pick-up spills using a clean, non-colored, lint-free cloth .