











# Assembly Instructions

Caution : You must read this before you proceed

## Care & Maintenance



-  ● Not for commercial use. For residential use only.
  -  ● Furniture may scratch floors. We recommend using furniture pads to protect your floors.
  -  ● Do not put hot items directly on furniture surface.
  -  ● Do not clean furniture with harsh cleansers or polish.
  -  ● Do not place furniture under direct sunlight.
  -  ● Do not place furniture near heating or cooling vents.
  -  ● Do not write on furniture without a padded barrier to protect the surface.
  -  ● Do not place furniture outside . For indoor use only.
  -  ● Stains may be removed with mild soap solution and damp cloth.
  -  ● Children should not climb or jump on the furniture.
- 
-  ● Dust and pick-up spills using a clean, non-colored, lint-free cloth.

**Please look in the magic tape pouch for hardware packs and legs**

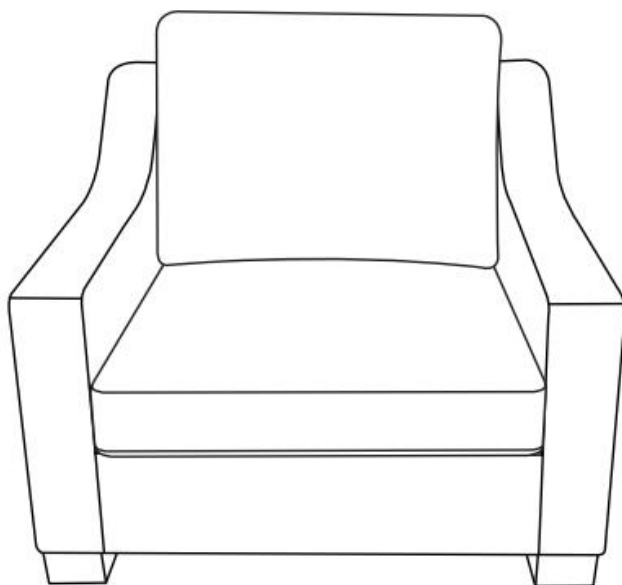

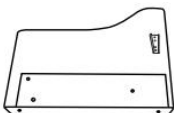
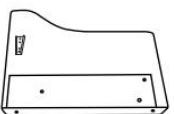
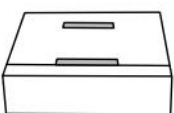
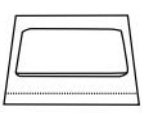
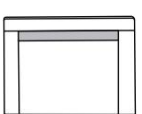

# CHAIR



## Parts List

Label	Picture	Description	QTY
A		Left Armrest	1
B		Right Armrest	1
C		Seat Frame	1
D		Seat Cushion	1
E		Backrest	1
F		Back Cushion	1
G		Leg	4

## Hardware List

Label	Picture	Description	QTY
①		Bolt(M8*40mm)	7
②		Bolt(M8*50mm)	5
③		Washer	11
④		Washer Rings	11
⑤		Allen Wrench	1

## Assembly Preparation

Before Beginning Assembly:

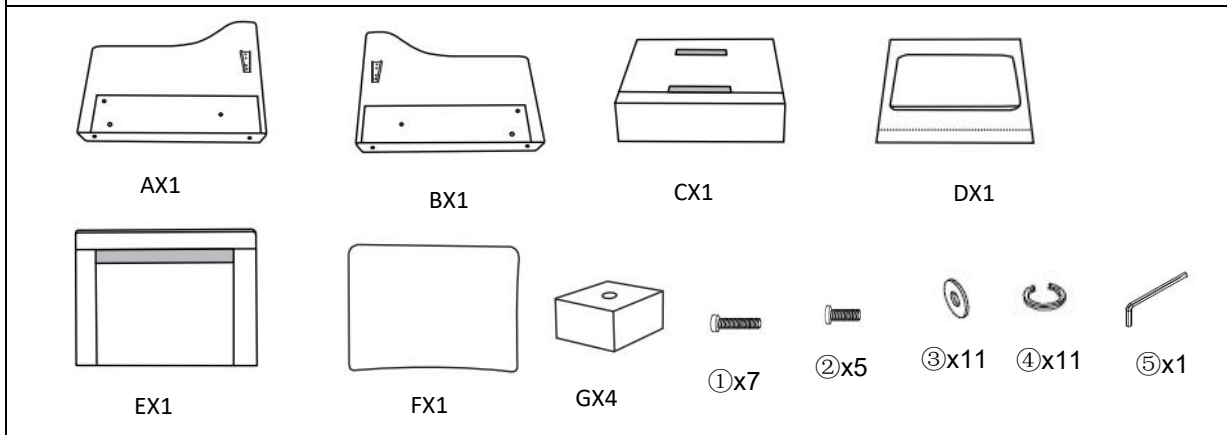

- Read instructions, cover to cover-



- Have 2 adults on hand for assembly-



- Do not assemble on flooring or carpet-



- Assemble on a clean non-marring surface (packing foam)-



- Save all packaging until finished-

## Assembly Steps

### OVERVIEW

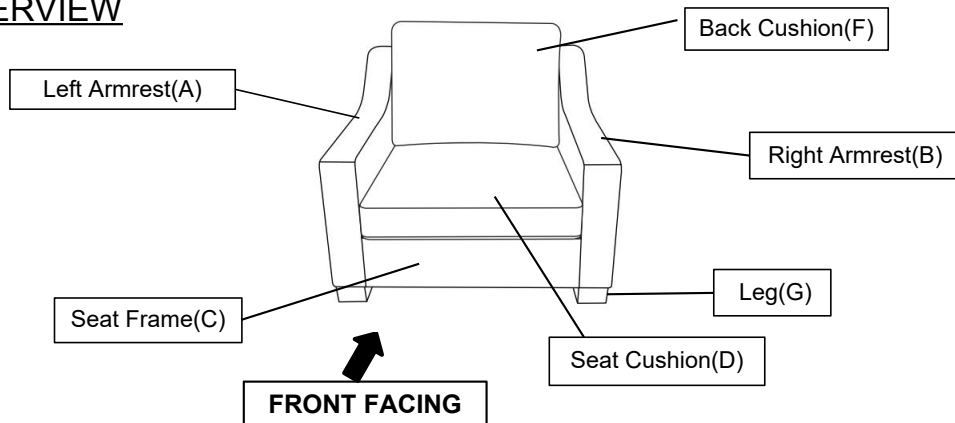

This Chair has multiple parts and may require up to 30 minutes to assemble. To give you an overview of the Chair parts, the above picture is to help you put the various parts into perspective. Please read through the instructions below to familiarise yourself with the parts and steps before assembly.

**Step 1**

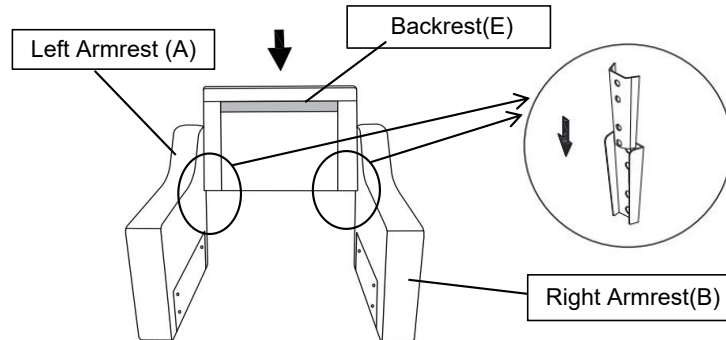

Position the product parts on a clean, non-marring surface. With assistance from your adult partners, slide the Tapered Connectors on the Backrest(E) into the Tapered Connectors on the Left Armrest(A) and Right Armrest(B) as shown in the picture.

**Step 2**

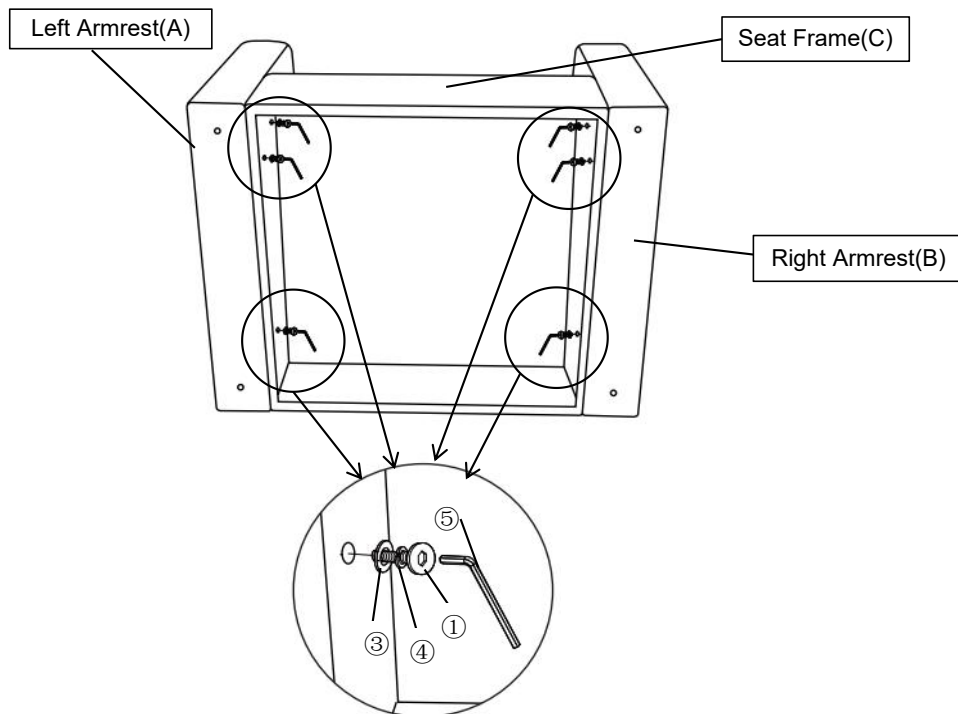

Install the Seat Frame(C) to the the Left Armrest (A) and Right Armrest(B) using Bolt (1),Washer Rings(4),Washer(3) with Allen Wrench(5). Tighten the Bolt by turning clockwise.

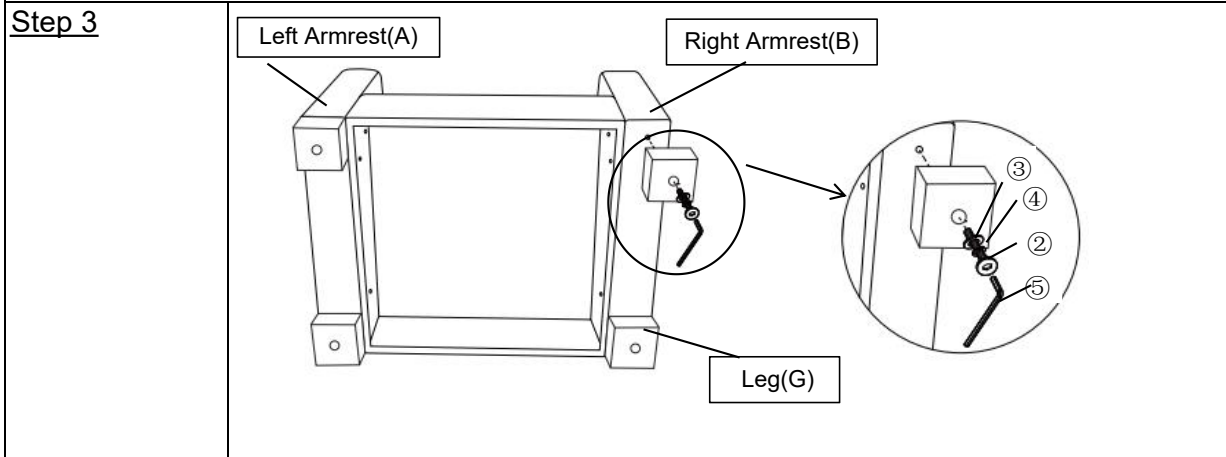

Install the Leg(G) onto the bottom of the Left Armrest (A) and Right Armrest(B) using Bolt(②),Washer Rings(④),Washer(③) with Allen Wrench(⑤).  
 Tighten the Bolt by turning clockwise.  
 Repeat the same step to install the remaining three legs.  
 If there are any wobbles after tightening, loosen the Bolts and Screws and execute this same process.

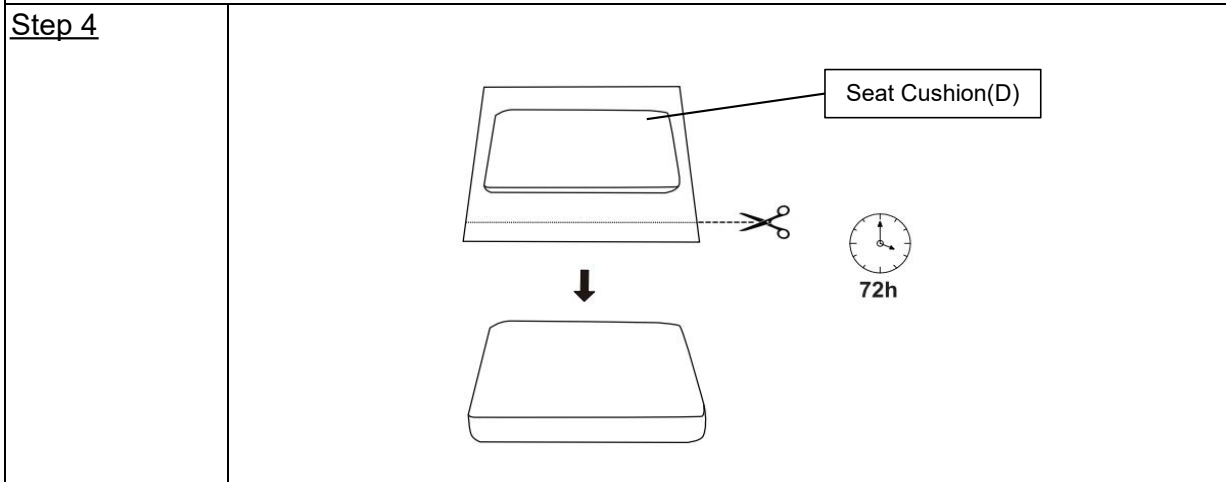

Open the compression Seat cushion(D) as shown.  
 Please be patient and wait for the cushion to return to its fluffy state, it might take up to 72 hours.

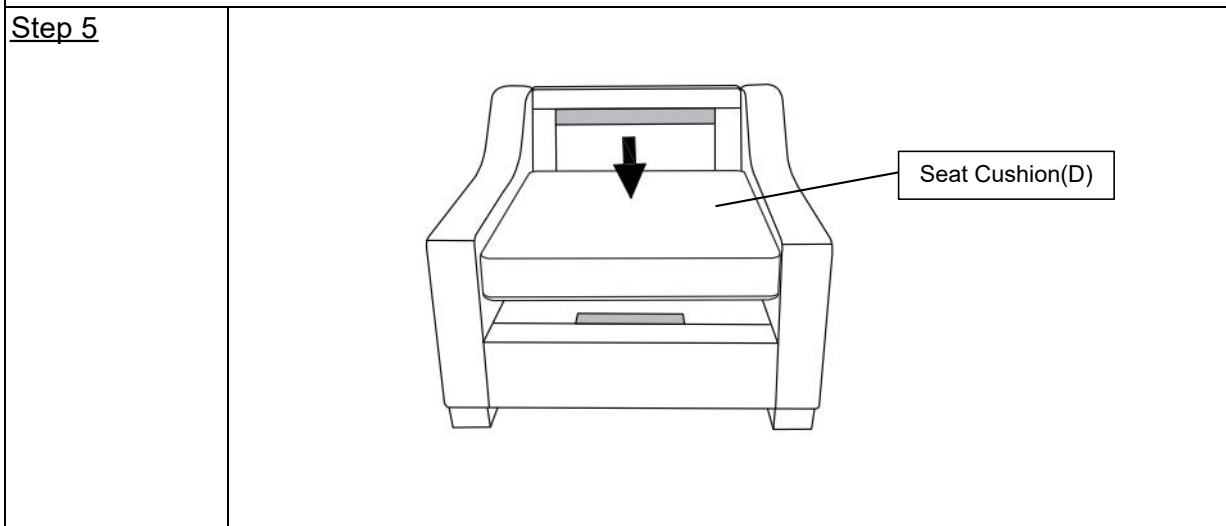

Place Seat Cushion(D) on the chair as shown above.

Step 6

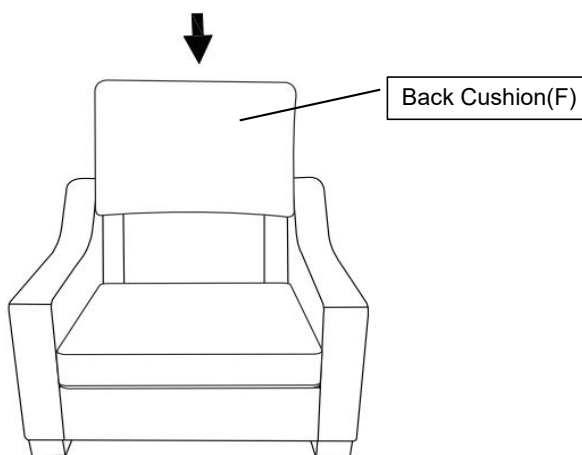

Put Back Cushion(F) on the chair as shown above.

Step 7

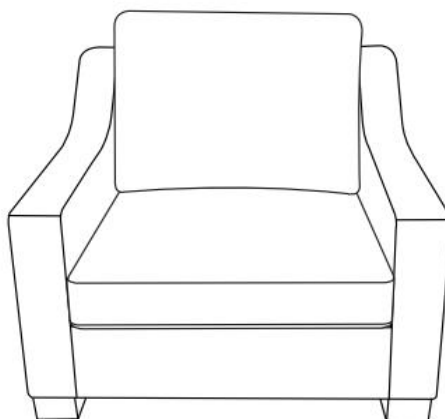

Your Chair is ready for use.  
Your Chair can only be used on a flat, level surface.