

# OAKHAM

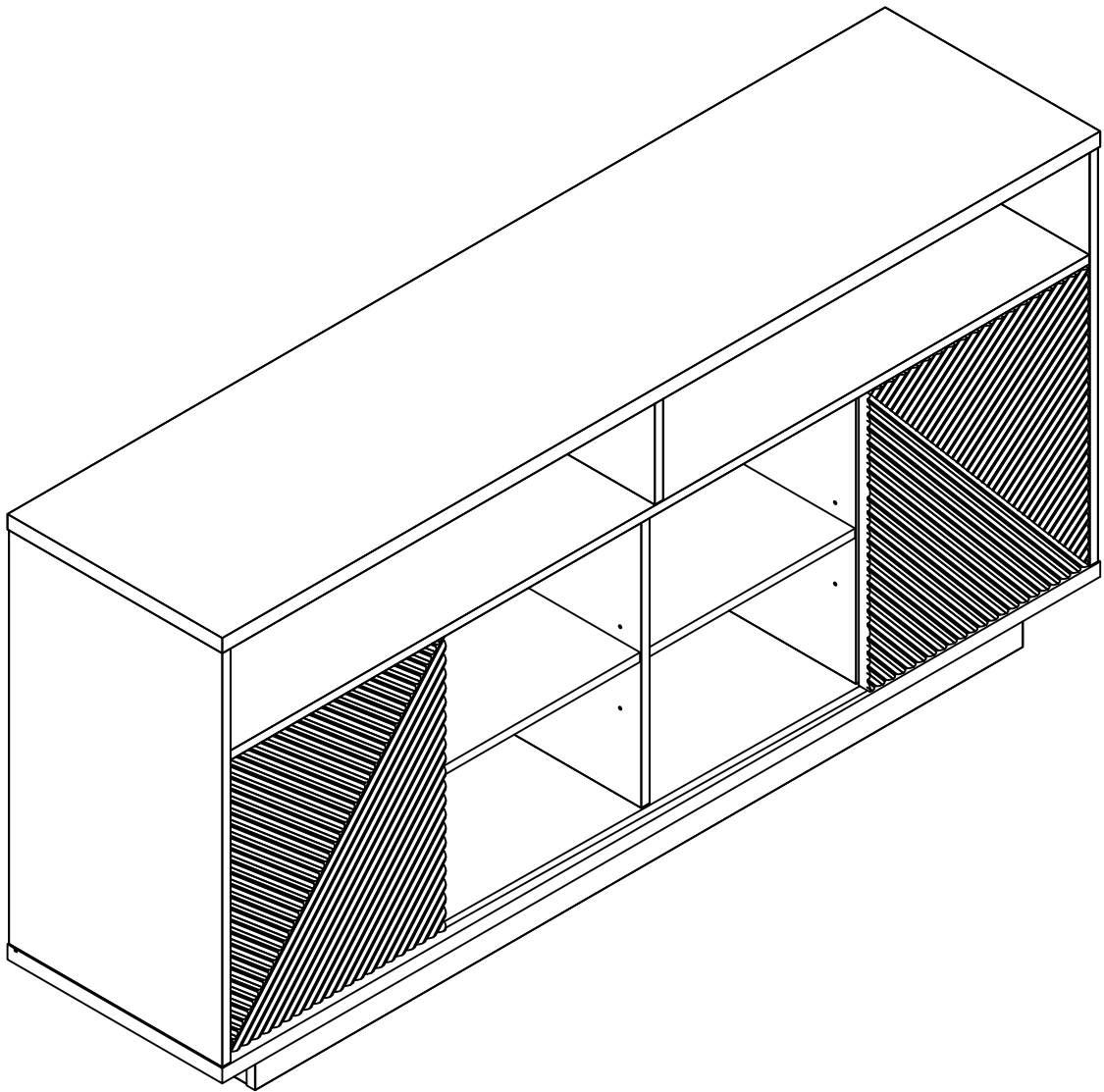

Scan to  
Watch Installation Video

## **QUESTIONS OR CONCERNS?**

**IMPORTANT!** Please read all instructions before use and keep this manual for future reference.

Your satisfaction is very important to us. If you have any issues, **PLEASE CONTACT US** at

**care@oakhamdesign.com** before initiating a **RETURN**.

# ATTENTION

## Attention Customers living in the United States and Canada

If you are missing parts, hardware, or if your product has been damaged during shipping

## DO NOT RETURN YOUR PRODUCT

The store does not stock parts and may not be able to help you. Please contact us directly and **we will ship you the parts** you need to your shipping address **at no cost to you**. For the quickest and most efficient service, please reach out to us at **care@oakhamdesign.com**. We're here to help!

※ **Stay Scratch-Free: Safeguard Your Furniture by Assembling on Carpet.**

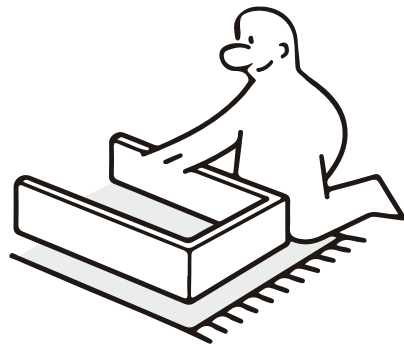
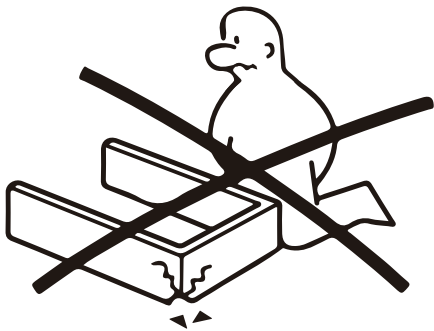

※ **Stuck in Assembly Limbo? Check out our website or contact our support team for quick solutions!**

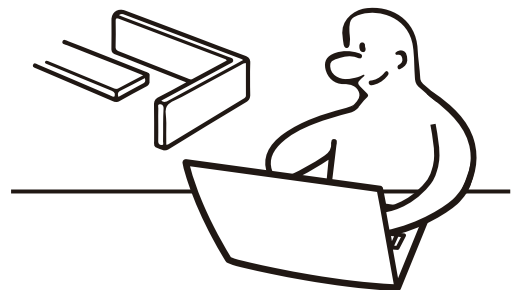
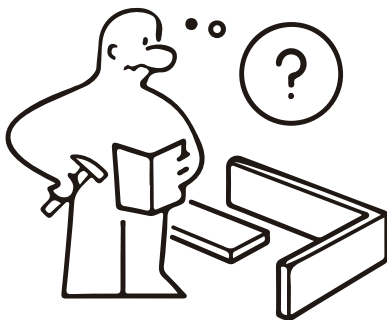

# WARNING: ASSEMBLY NOTICE

## Attention

Important Instructions for Assembling Your Furniture To ensure the longevity and integrity of your MDF furniture, please adhere to the following guidelines:

### DO NOT USE AN ELECTRIC DRILL

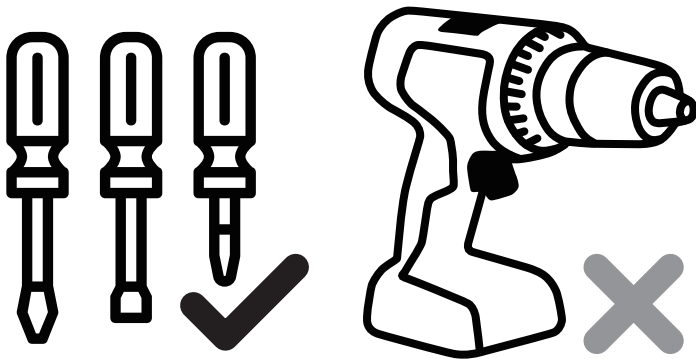

Using an electric drill can cause irreversible **damage to the MDF boards**, leading to compromised structural integrity and potential voiding of your warranty.

---

### IF AN ELECTRIC DRILL MUST BE USED

- **Set to Lowest Torque Setting :**

Ensure your drill is set to the lowest possible torque setting to avoid over-tightening and damaging the material.

- **Proceed with Caution :**

Carefully monitor the drilling process to prevent excessive force and damage.

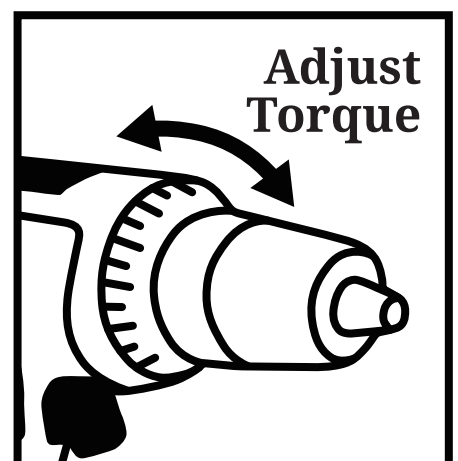

---

For best results and to avoid any damage, we highly recommend using the provided manual tools or a handheld screwdriver.

Thank you for your attention and understanding.

# PARTS LIST

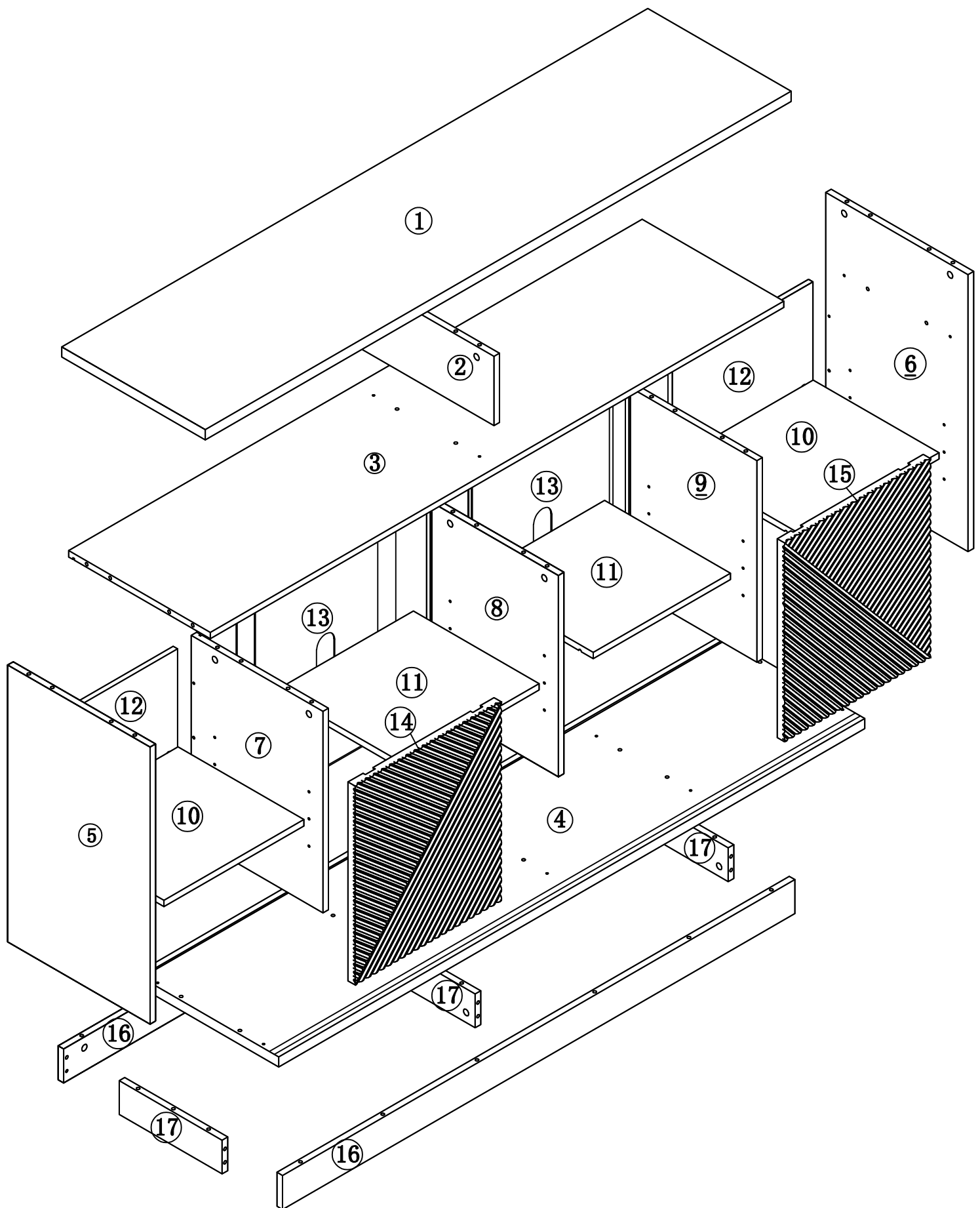



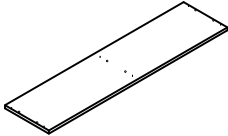
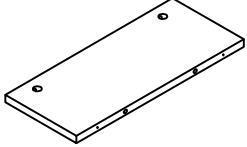
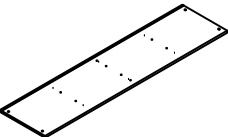
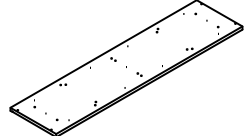
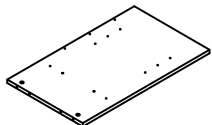
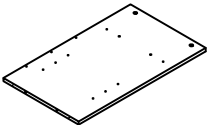
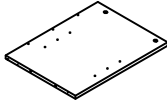
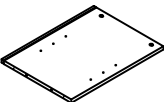
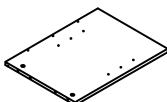
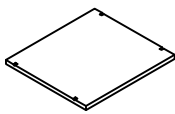

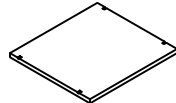
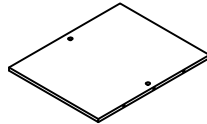
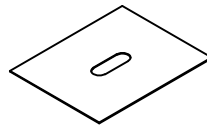
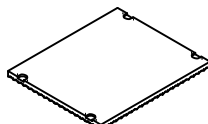
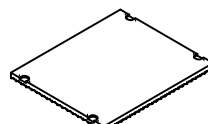
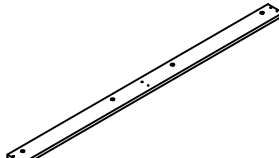
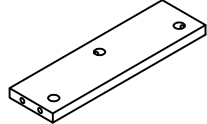
# PARTS LIST

Item	Reference Image	Qty
1		x1
2		x1
3		x1
4		x1
5		x1
6		x1
7		x1
8		x1
9		x1
10		x2

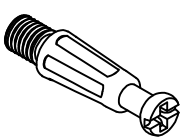
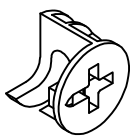
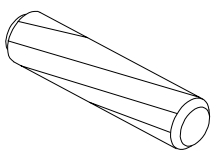
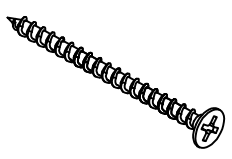
Item	Reference Image	Qty
11		x2
12		x2
13		x2
14		x1
15		x1
16		x2
17		x3

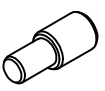
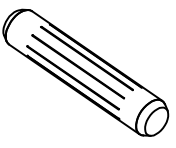
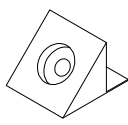
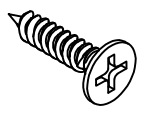
# HARDWARE LIST

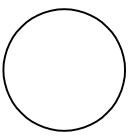
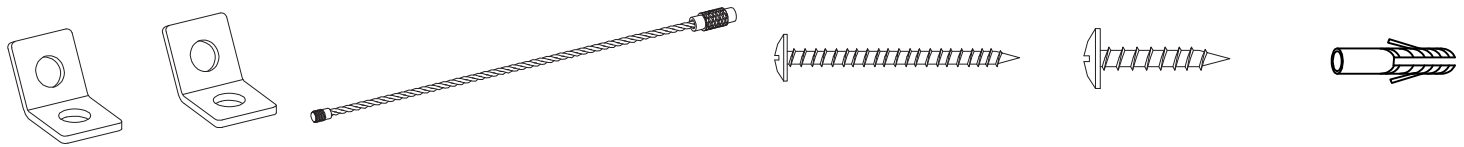
<p><b>A</b></p>  <p>x37</p>	<p><b>B</b></p>  <p>x37</p>	<p><b>C</b></p>  <p>ø8x30MM x44</p>	<p><b>D</b></p>  <p>ø4x40MM x12</p>
<p><b>E</b></p>  <p>x4</p>	<p><b>F</b></p>  <p>x4</p>	<p><b>G</b></p>  <p>x16</p>	<p><b>H</b></p>  <p>ø6x30MM x8</p>
<p><b>J</b></p>  <p>x8</p>	<p><b>K</b></p>  <p>ø3x16mm x8</p>	<p><b>L</b></p>  <p>ø3x12mm x16</p>	<p><b>N</b></p>  <p>x37</p>
<p><b>I</b></p>  <p>a b c d e</p> <p>x2</p>			

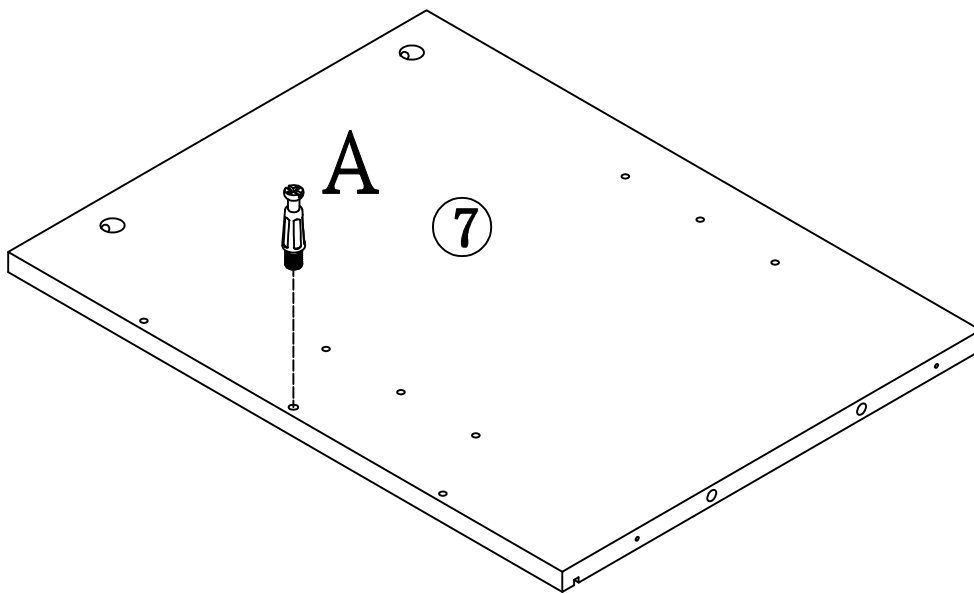
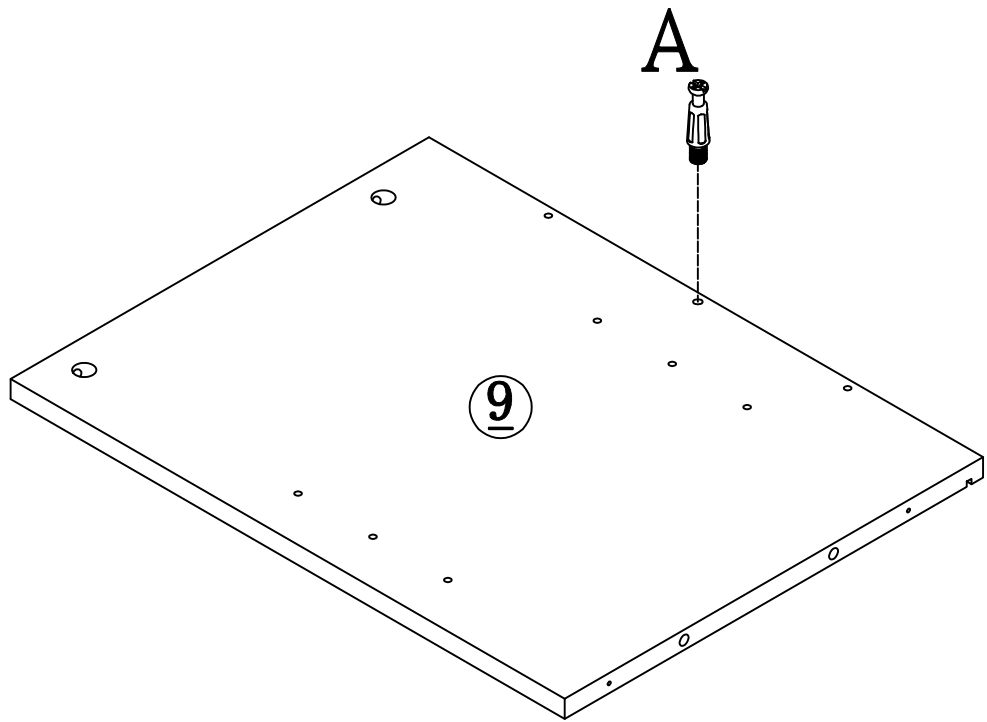
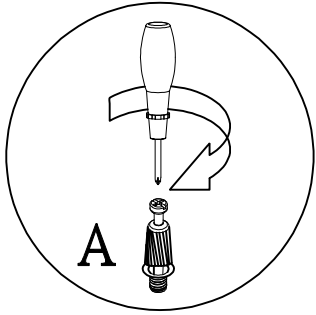
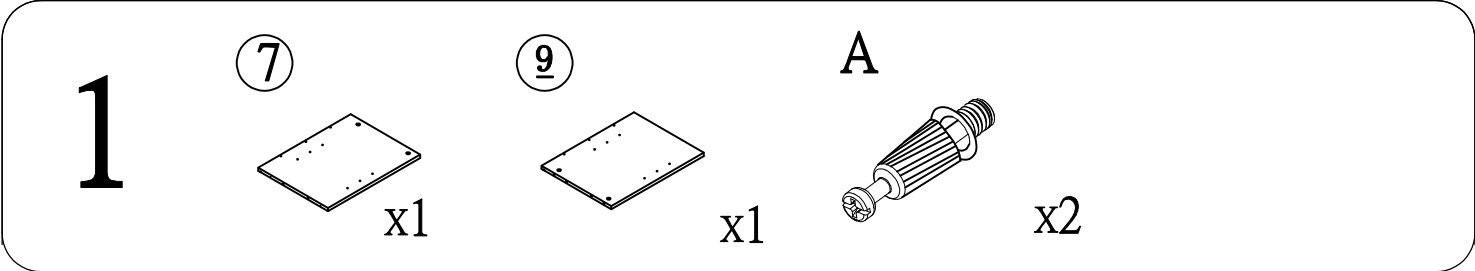

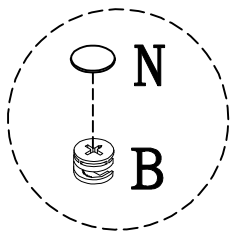
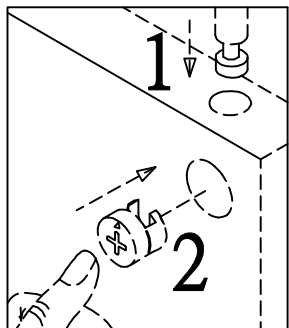
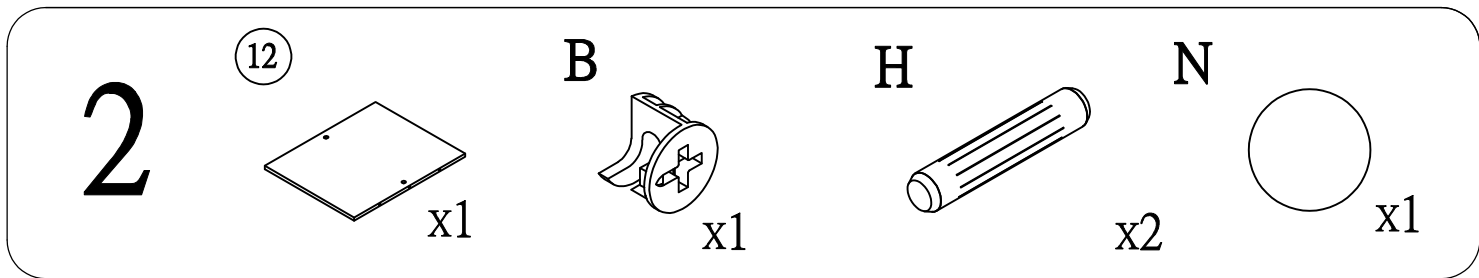

(B) After the eccentric wheel is locked on the plate, use (N) hole sticker to cover it

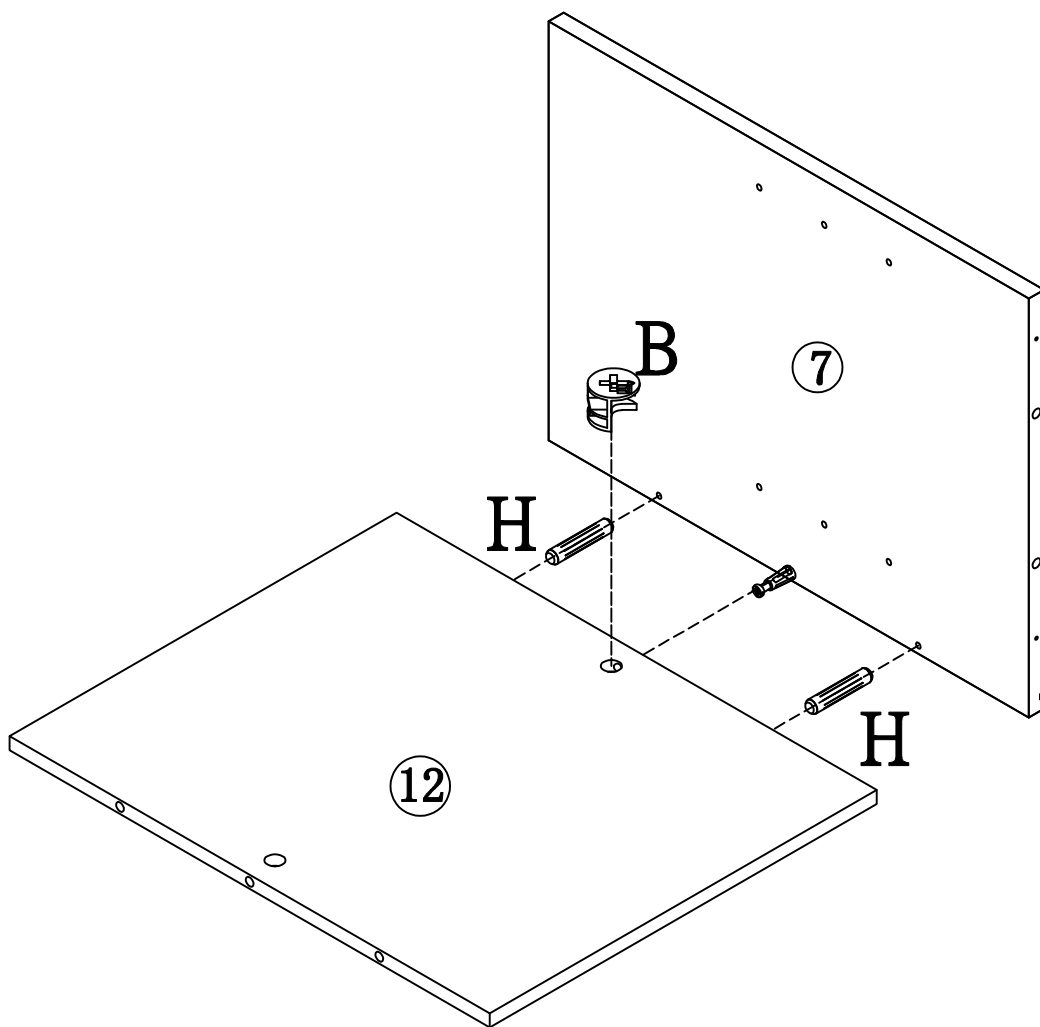
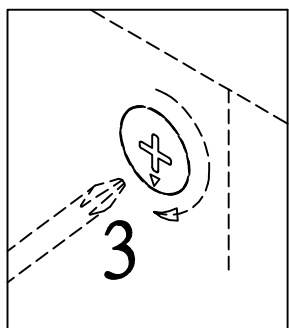

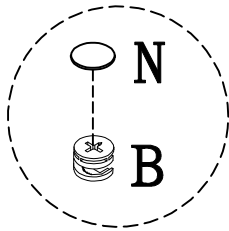
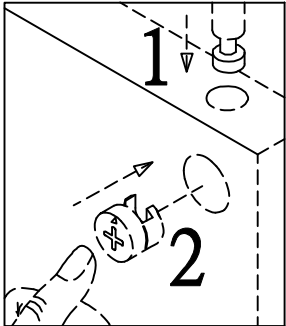
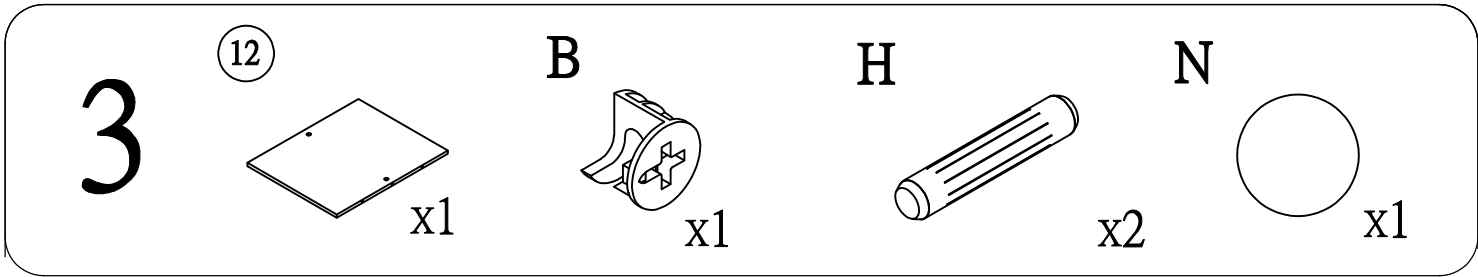

(B) After the eccentric wheel is locked on the plate, use (N) hole sticker to cover it

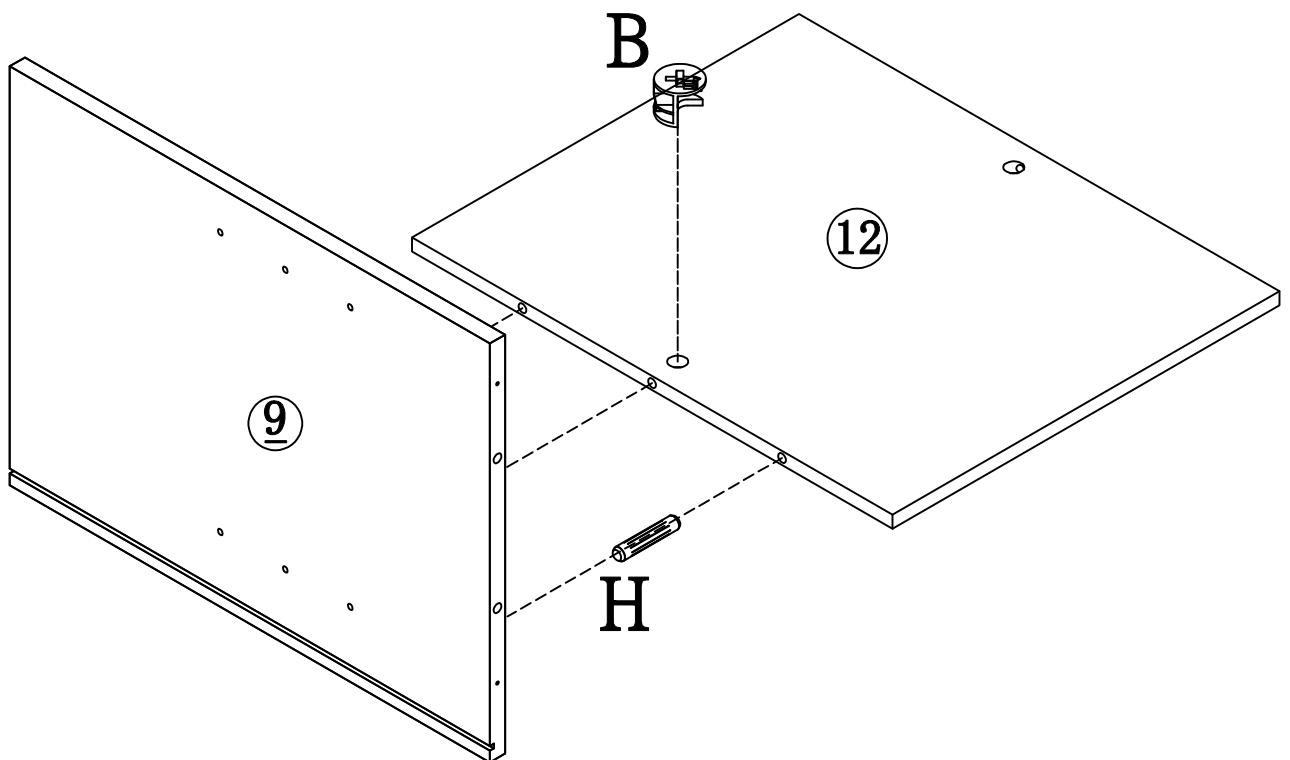
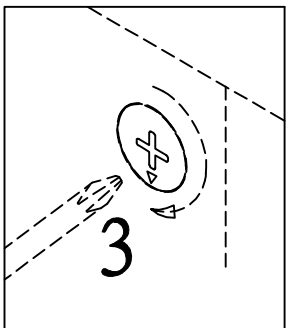

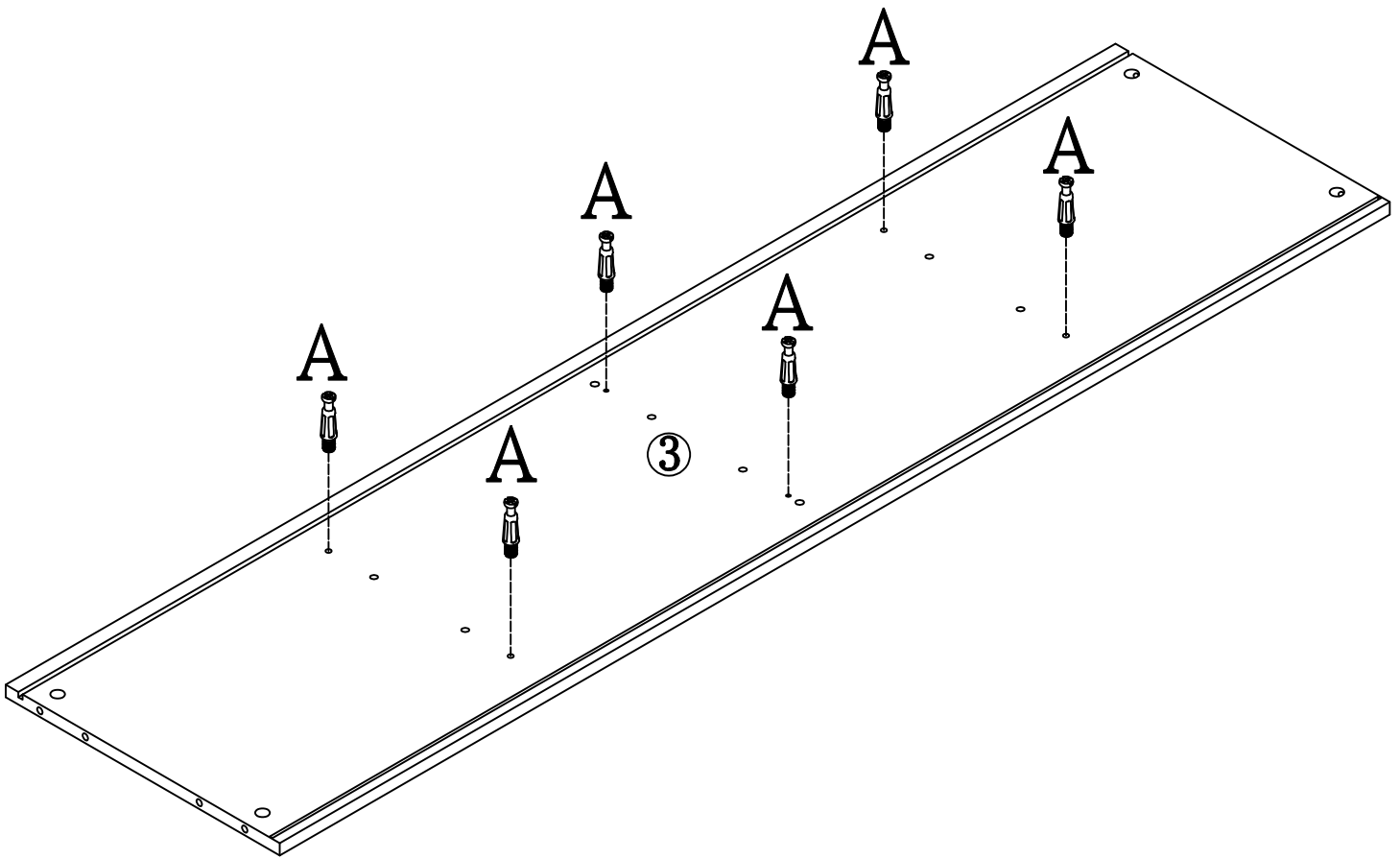
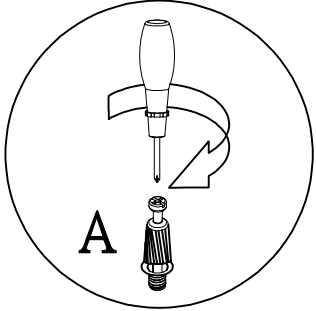
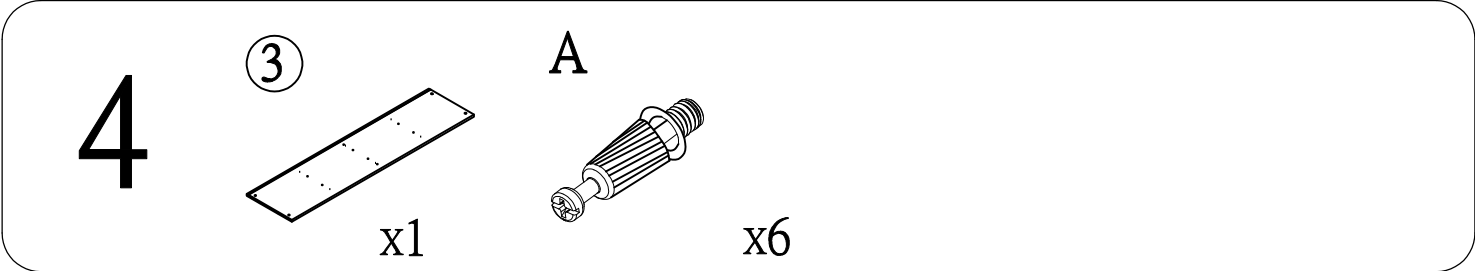

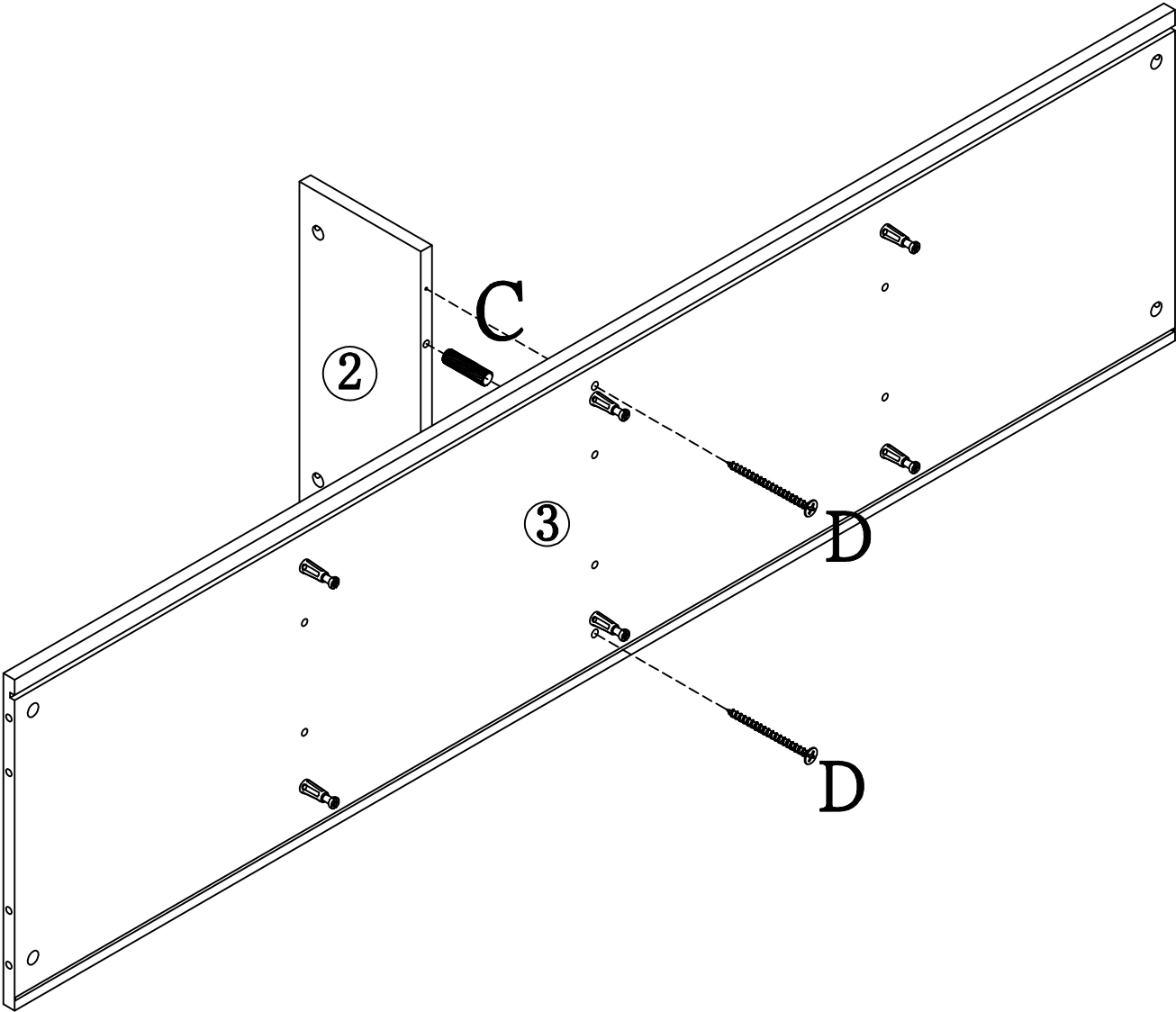
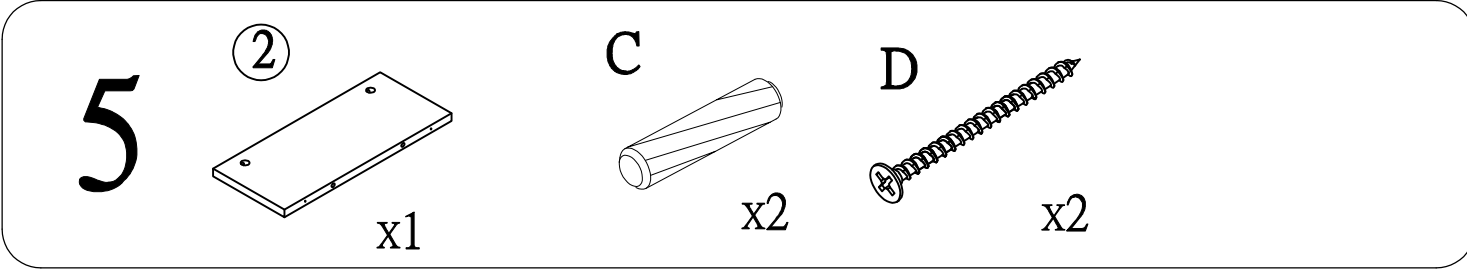

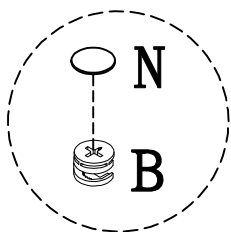
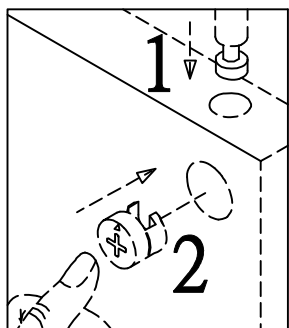
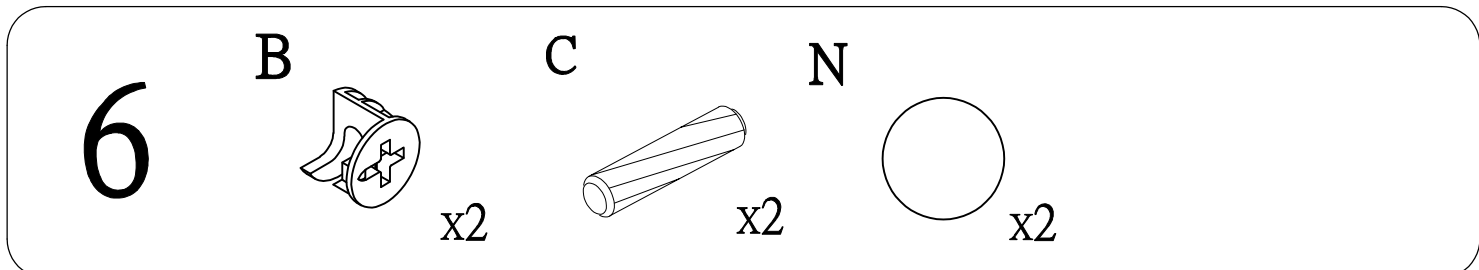

(B) After the eccentric wheel is locked on the plate, use (N) hole sticker to cover it

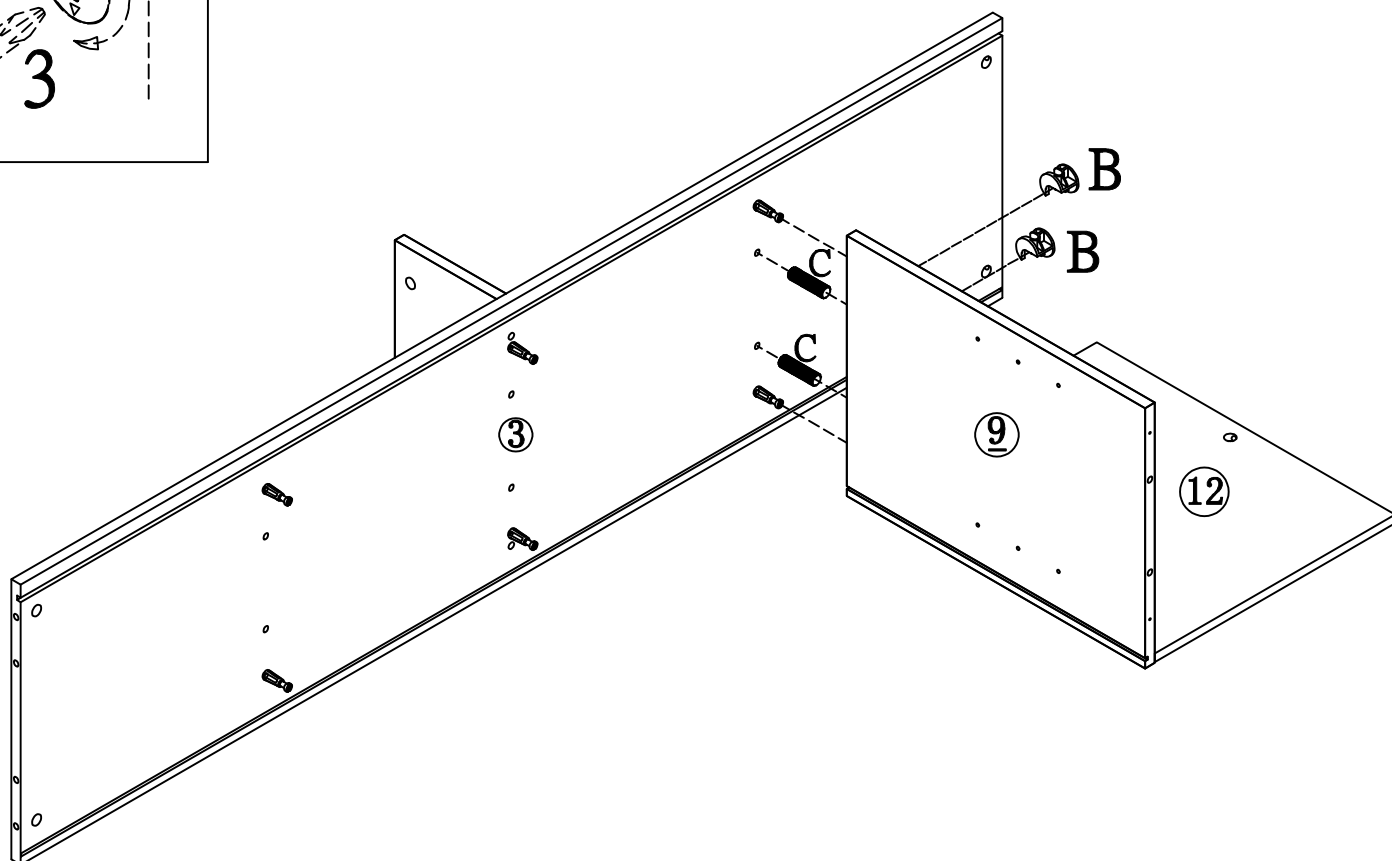
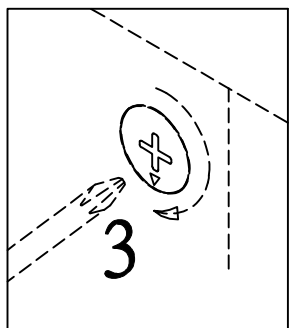

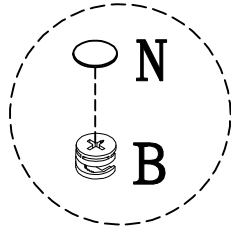
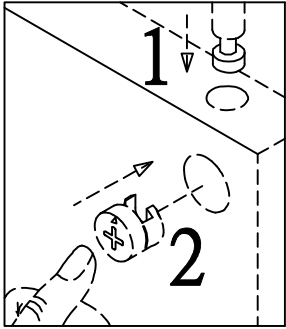
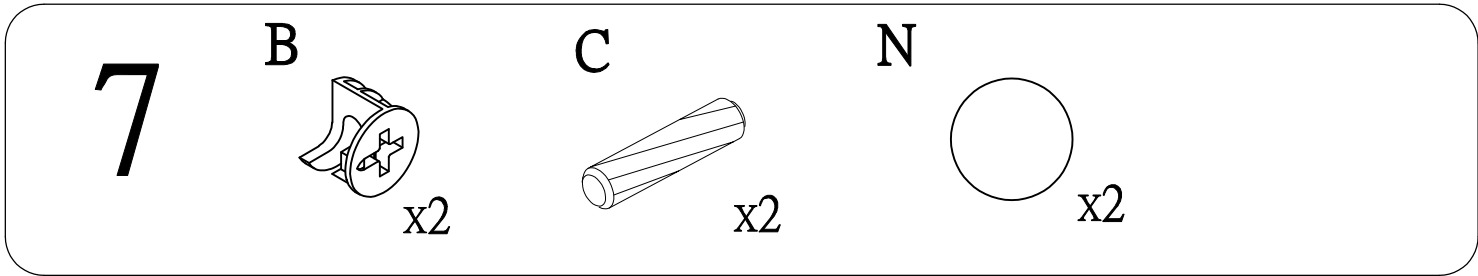

(B) After the eccentric wheel is locked on the plate, use (N) hole sticker to cover it

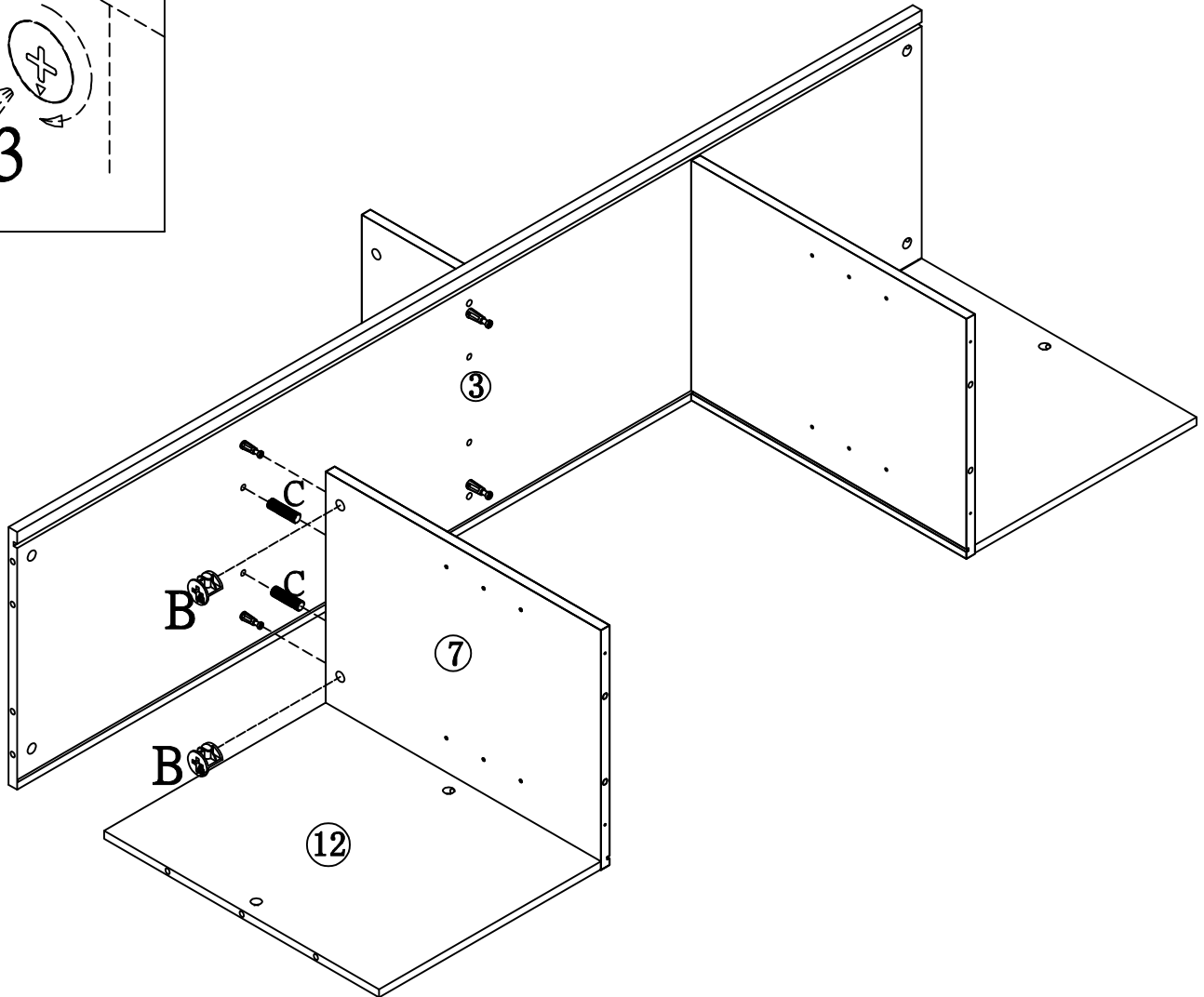
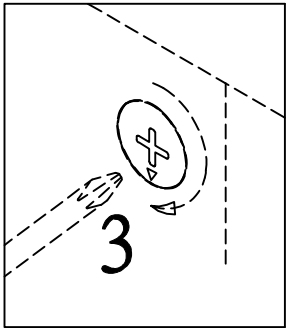

8

B

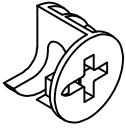

x2

C

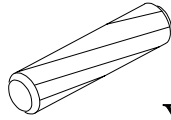

x2

N

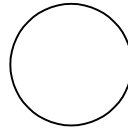

x2

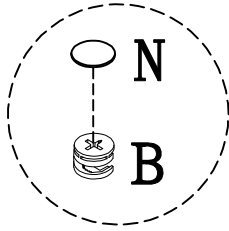
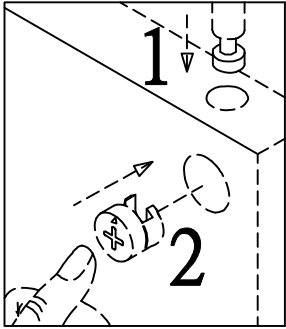

(B) After the eccentric wheel is locked on the plate, use (N) hole sticker to cover it

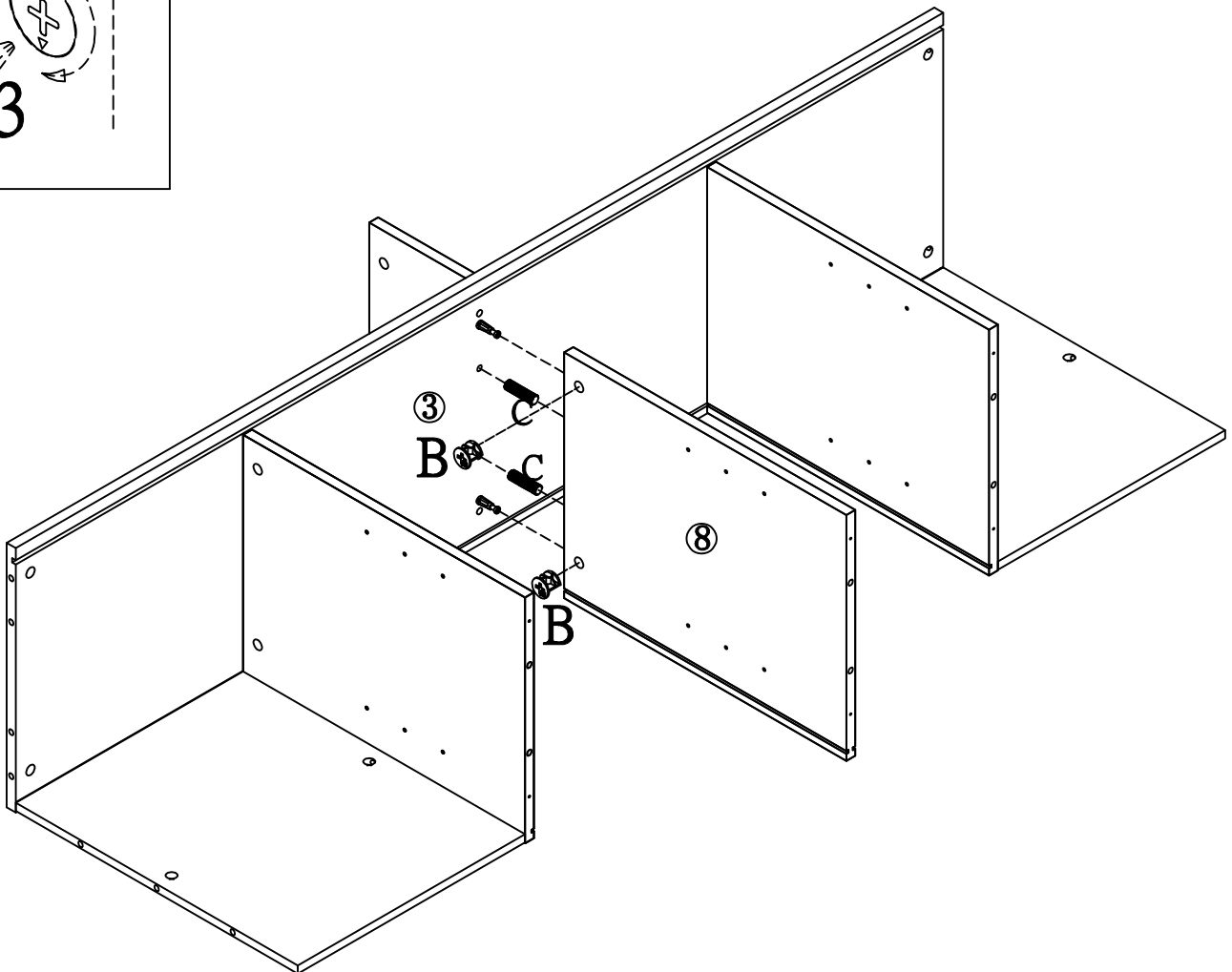
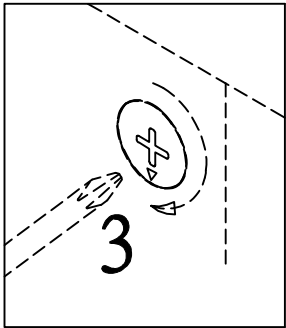

9

5

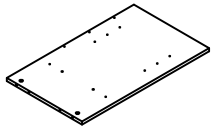

x1

6

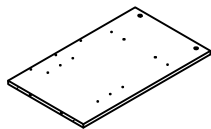

x1

A

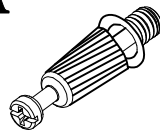

x6

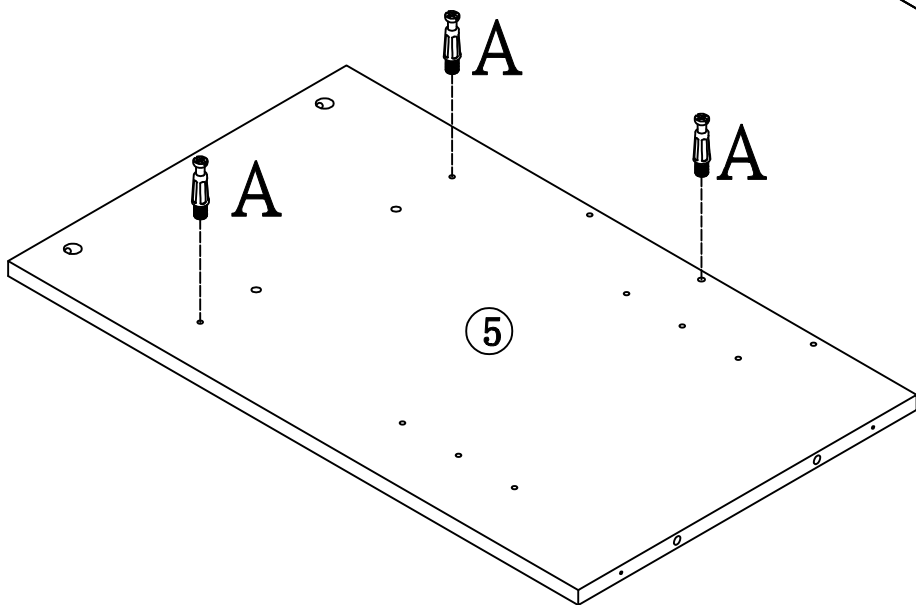
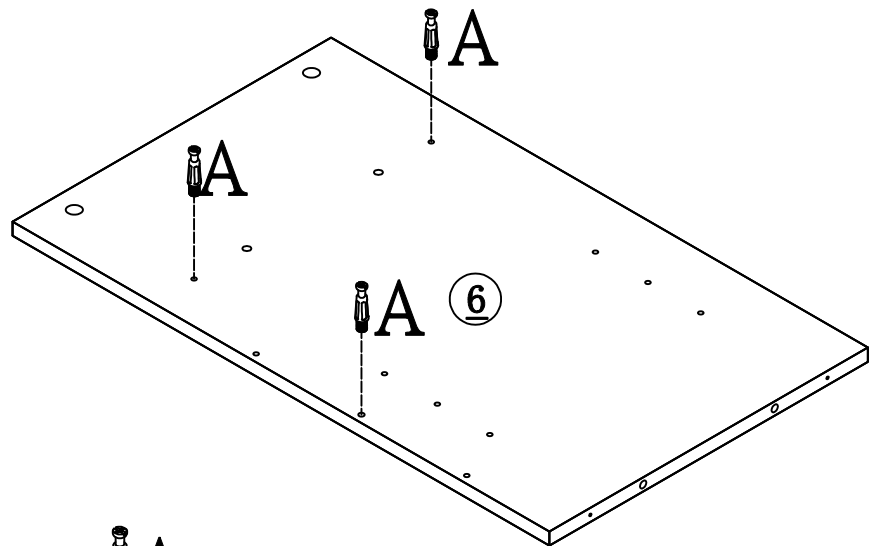
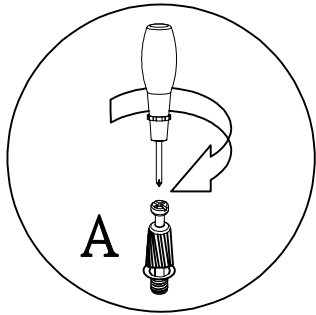

# 10

B

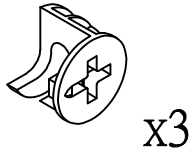

C

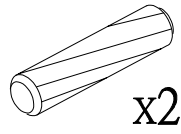

H

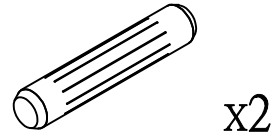

N

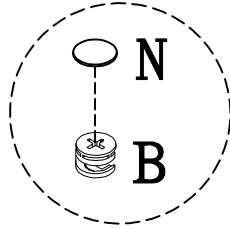
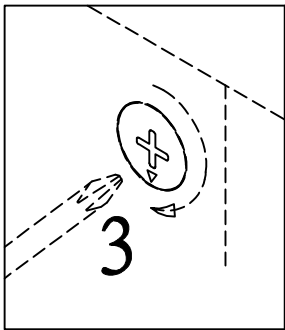
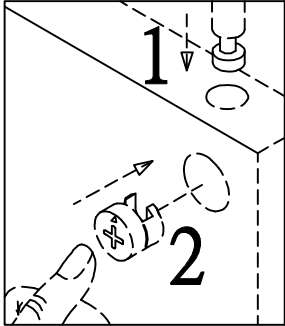
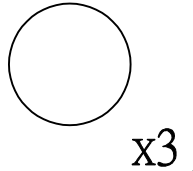

(B) After the eccentric wheel is locked on the plate, use (N) hole sticker to cover it

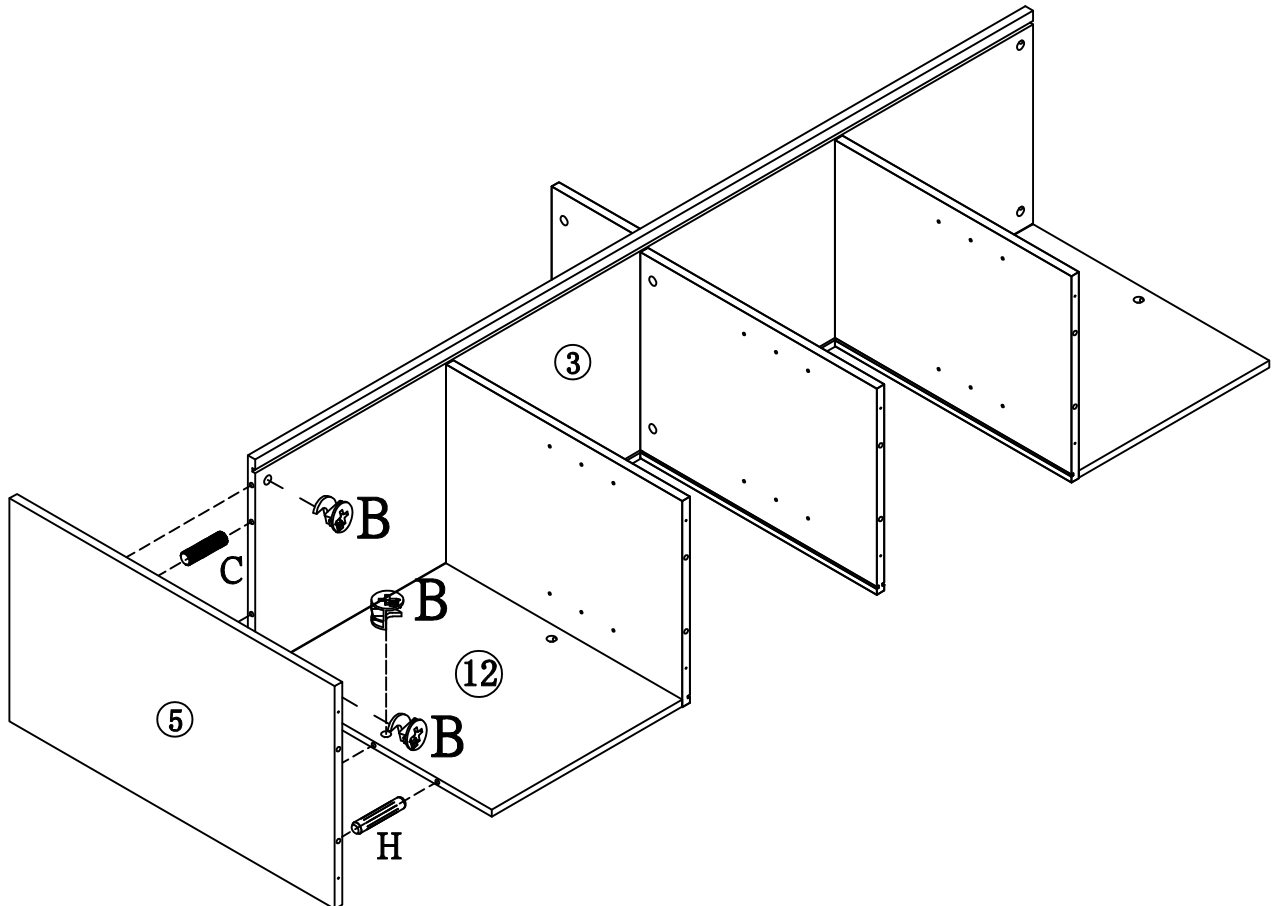

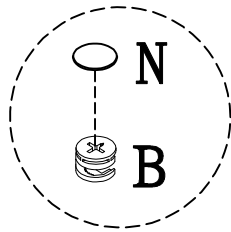
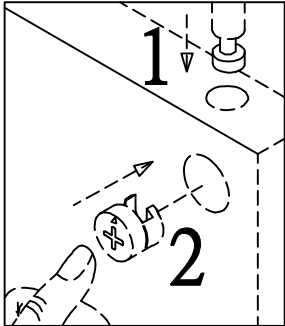
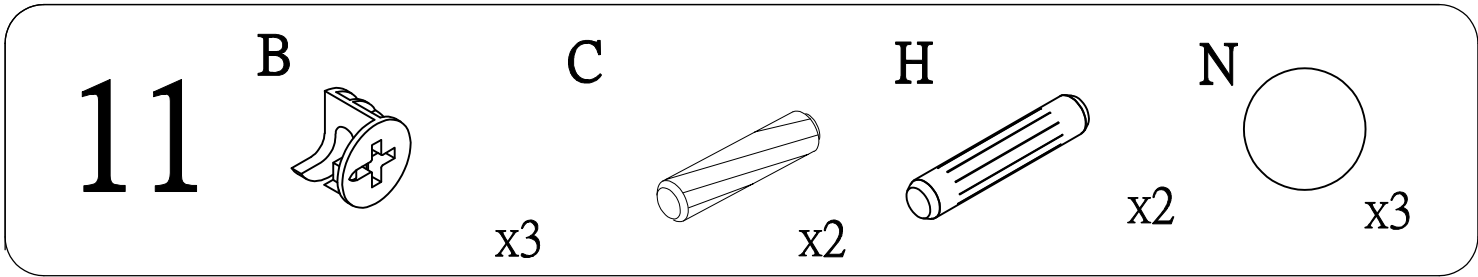

(B) After the eccentric wheel is locked on the plate, use (N) hole sticker to cover it

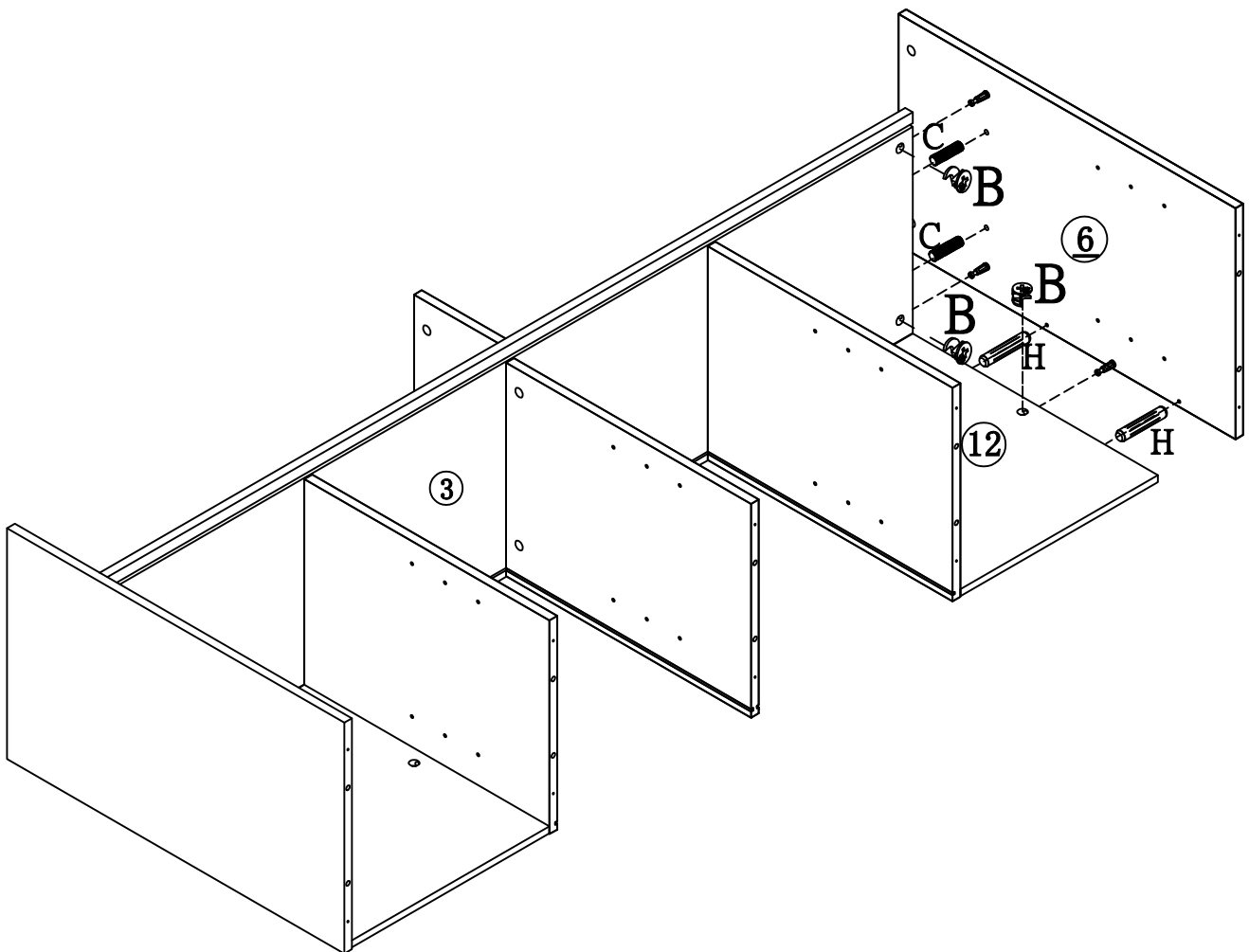
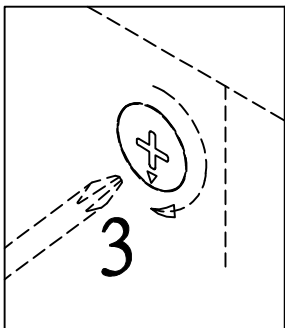

12 <sup>13</sup>  
x2

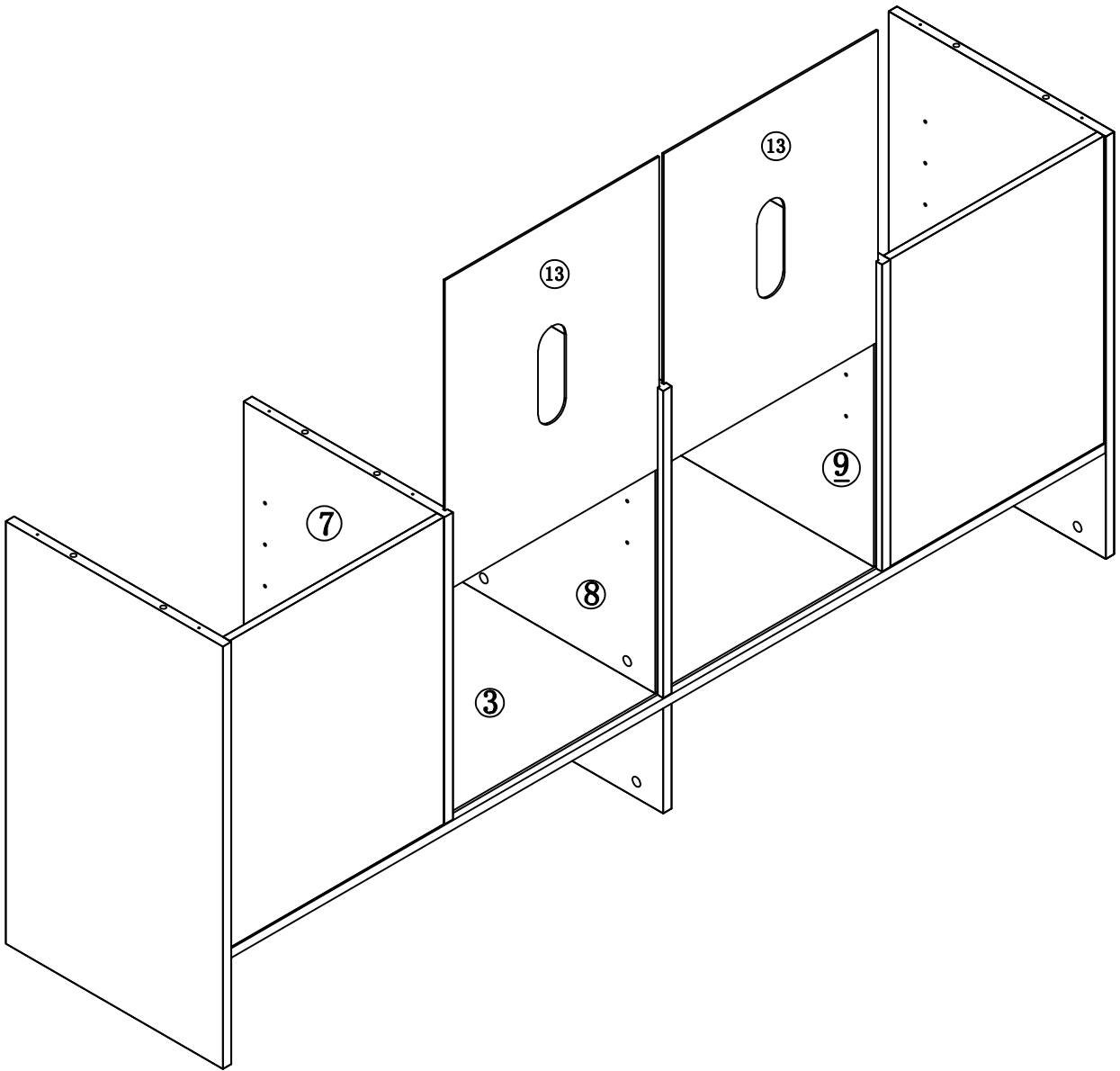
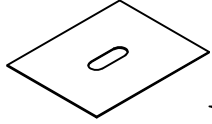

13

4

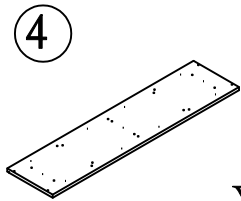

A  
x1

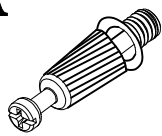

x11

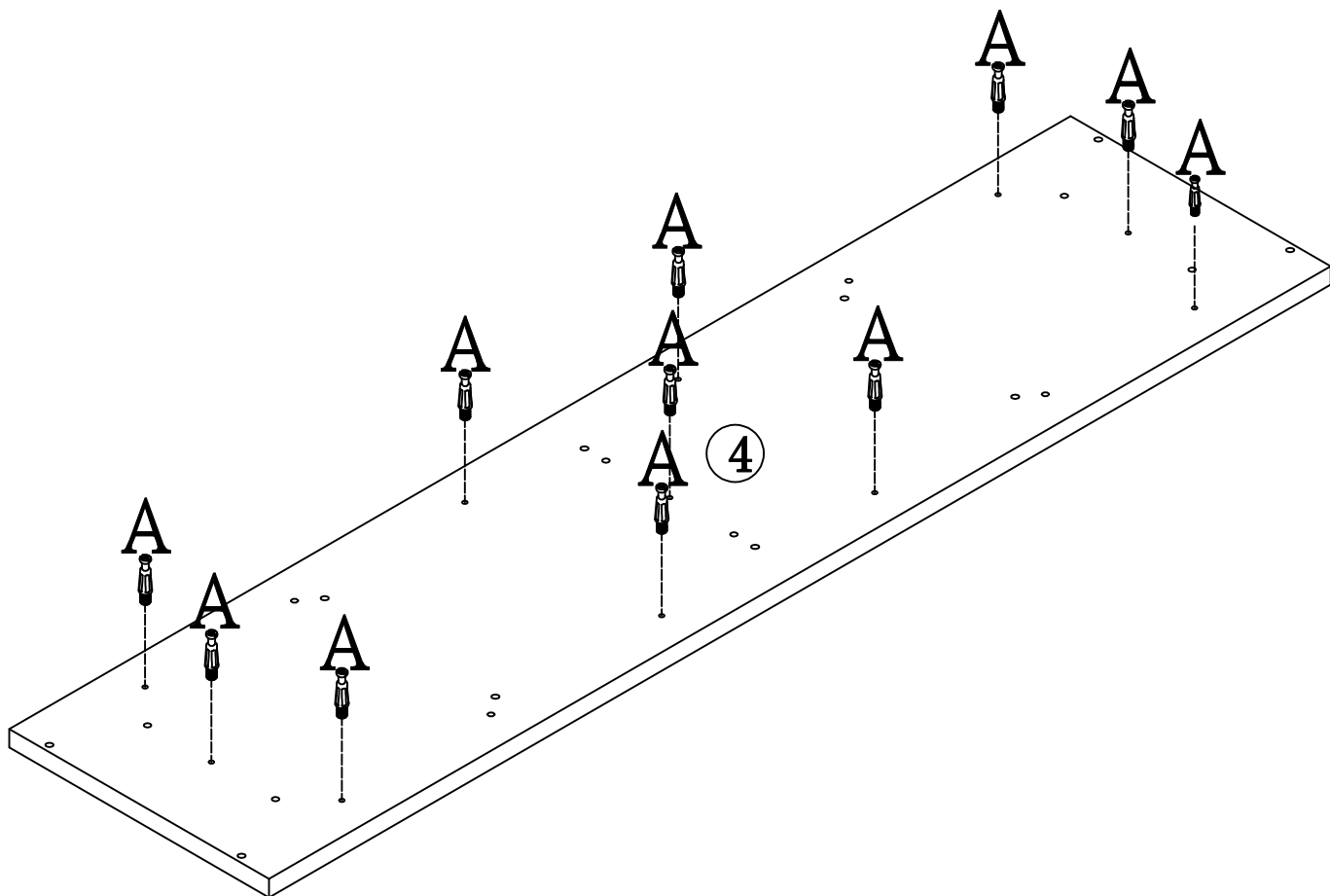
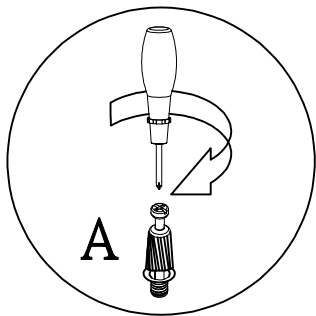

14

C

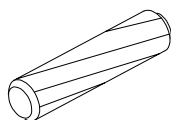

x10

D



x10

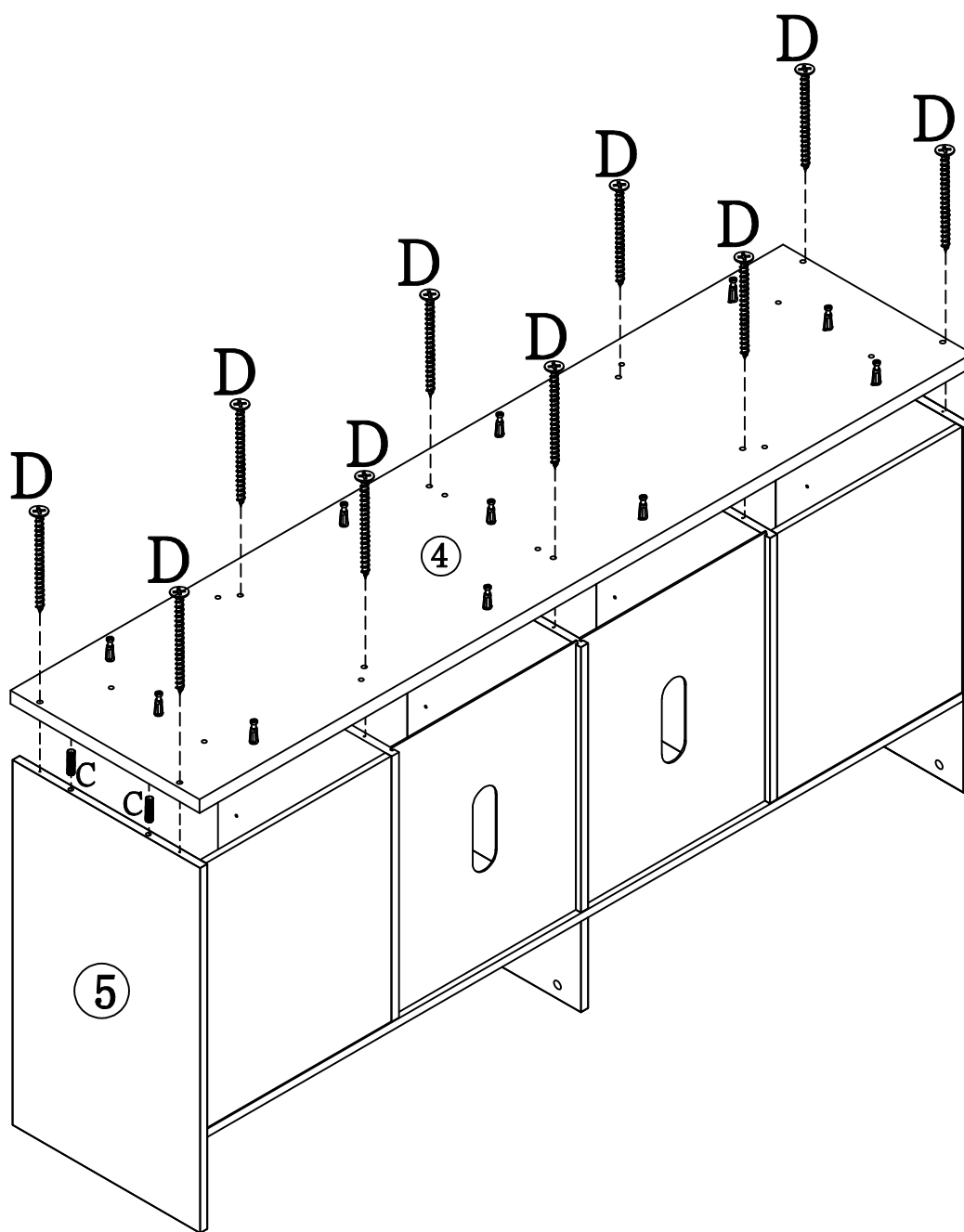

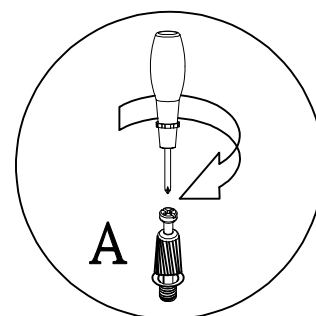
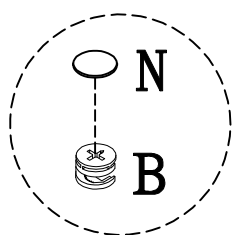
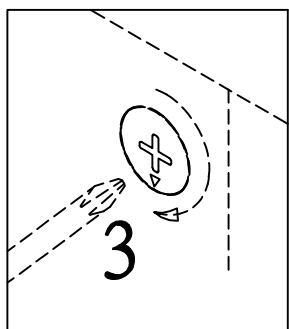
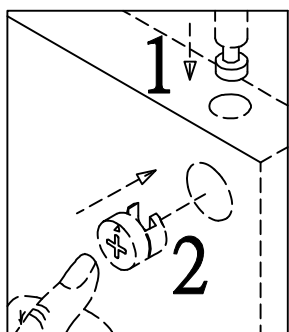
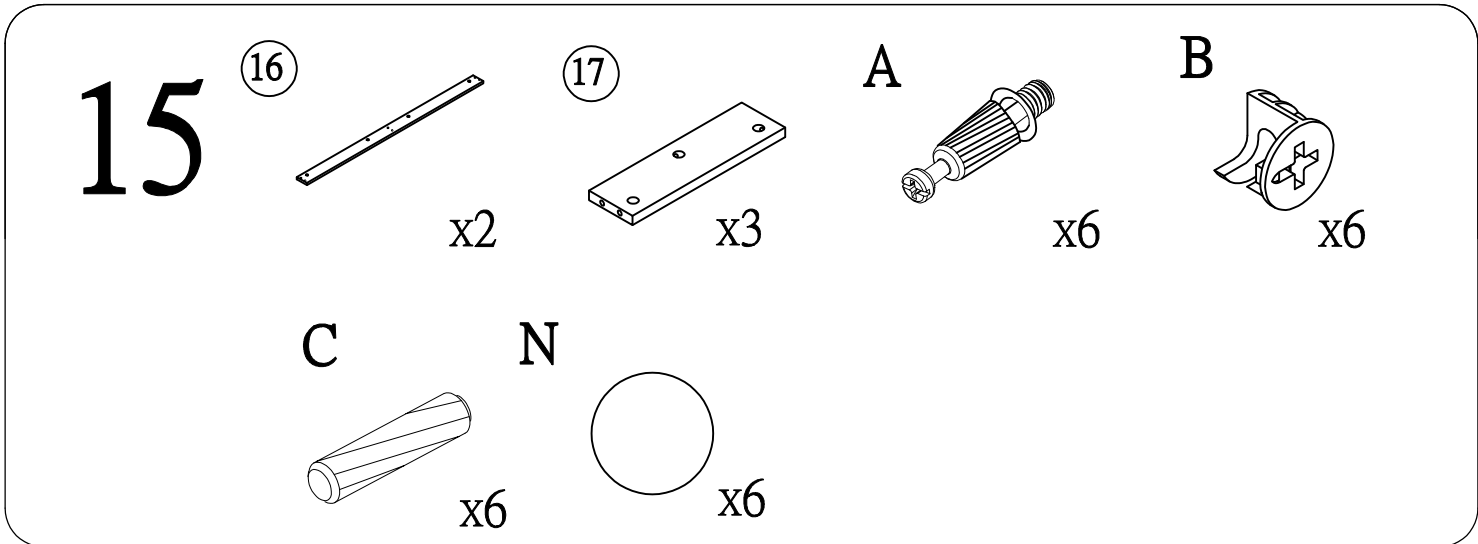

(B) After the eccentric wheel is locked on the plate, use (N) hole sticker to cover it

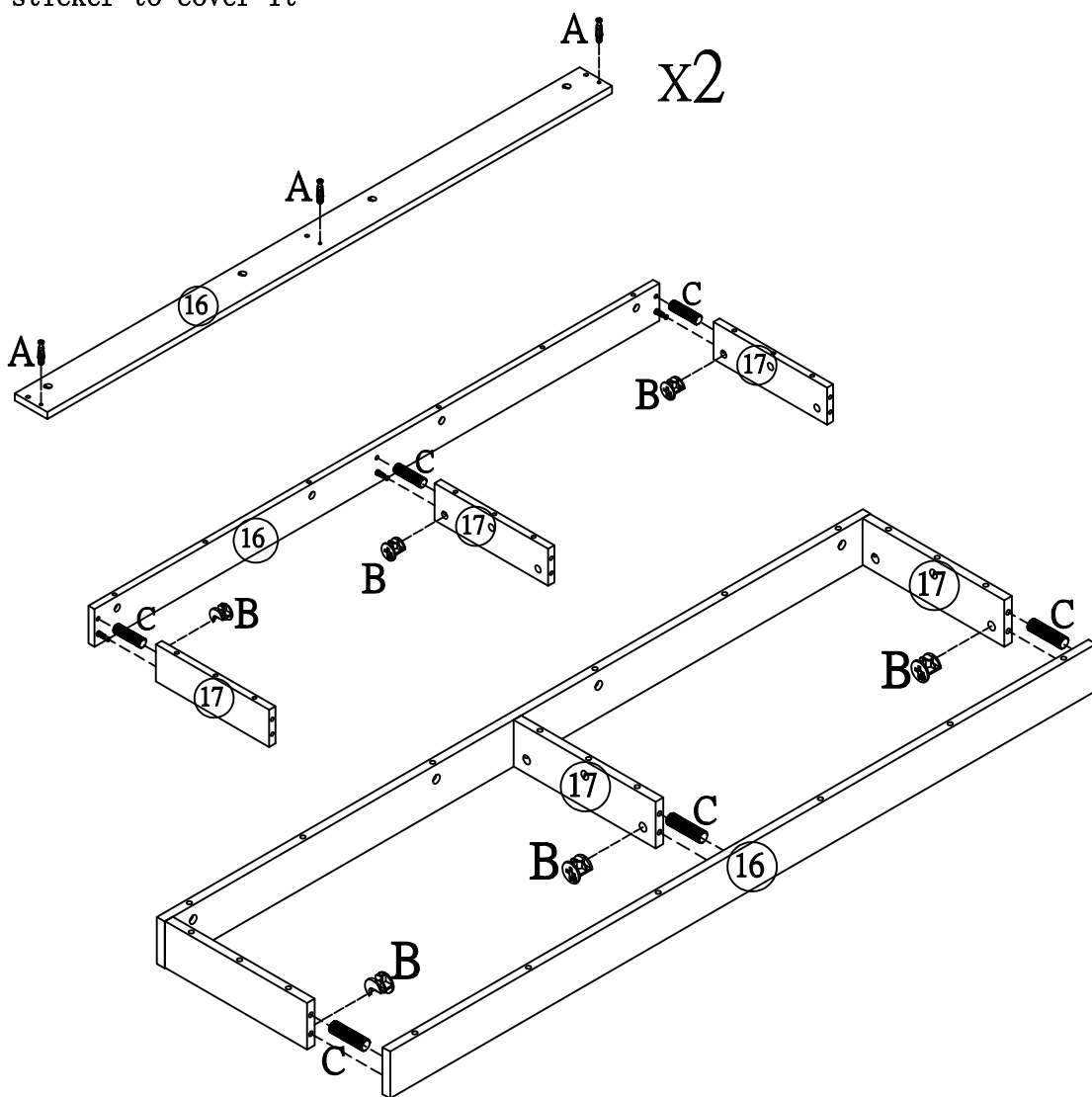

# 16

B

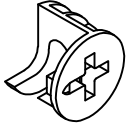

x11

C

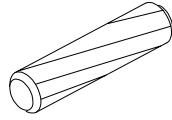

x10

N

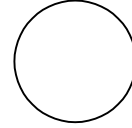

x11

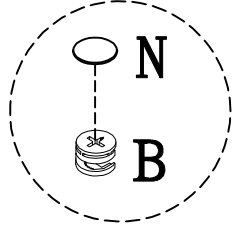
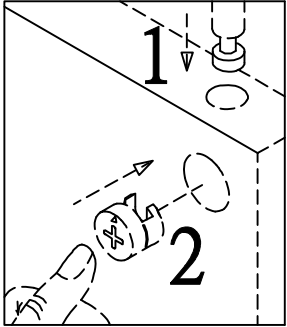

(B) After the eccentric wheel is locked on the plate, use (N) hole sticker to cover it

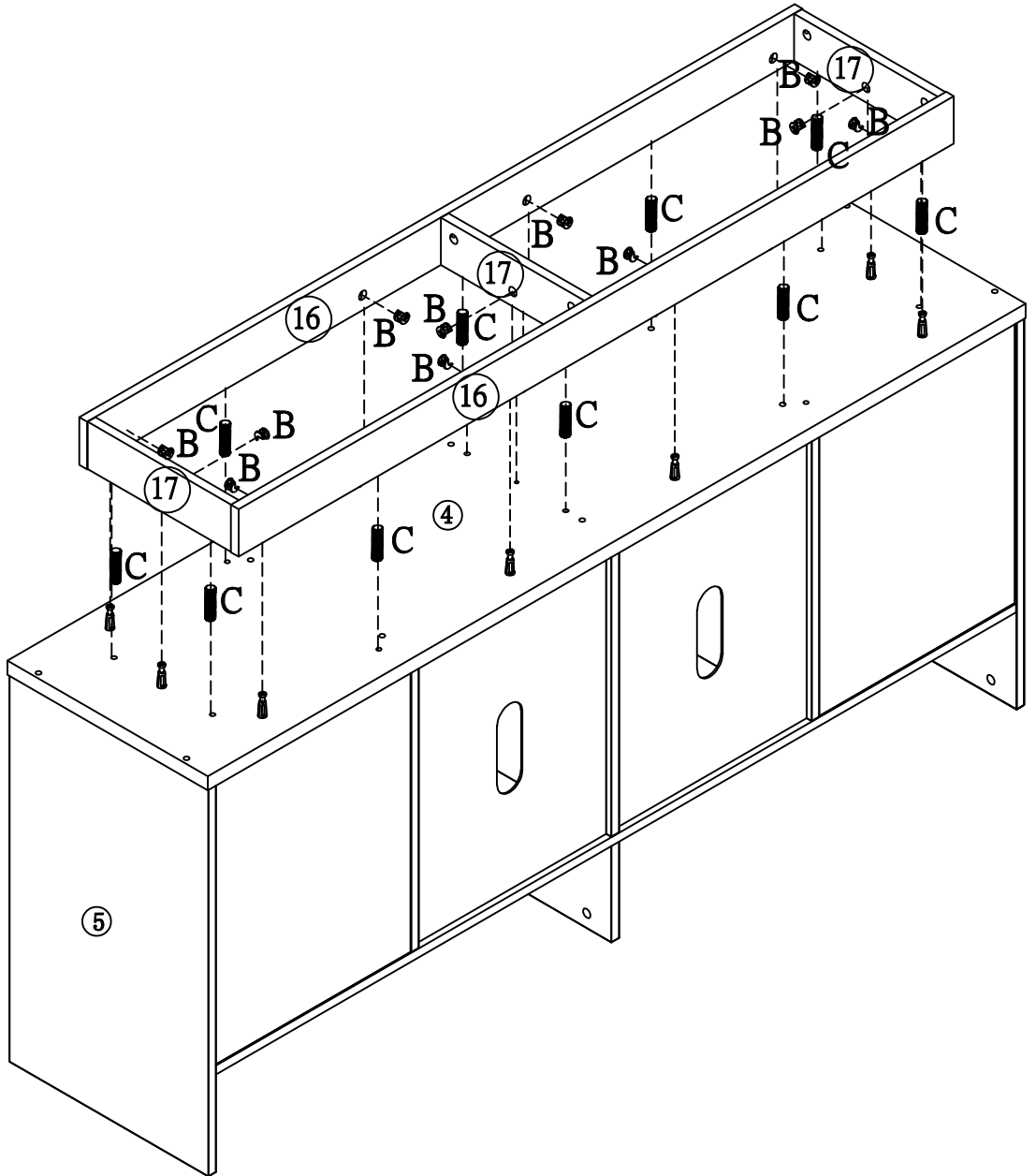
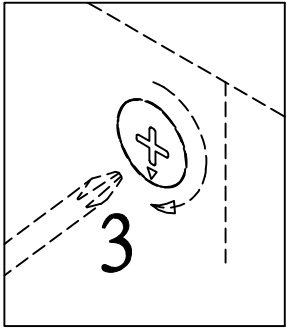

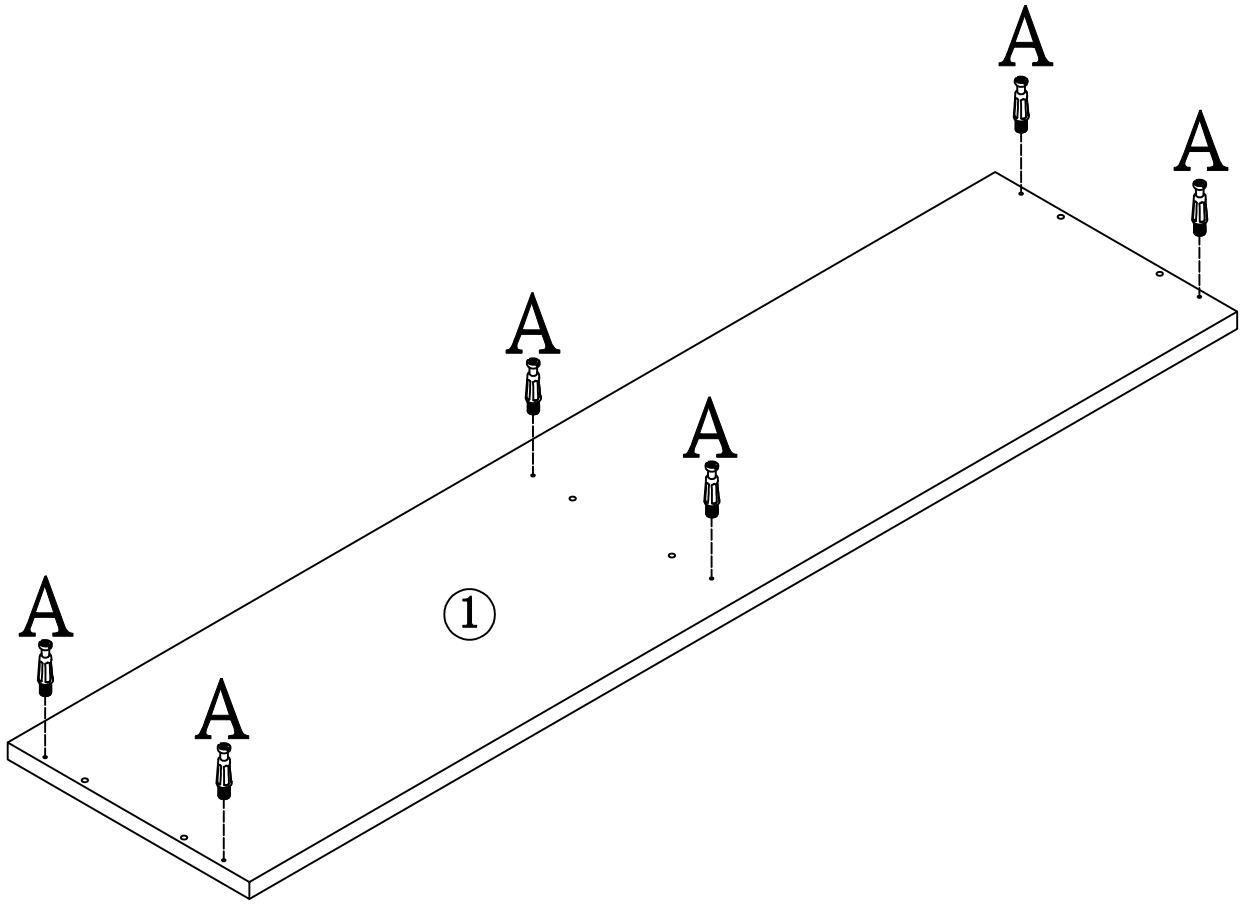
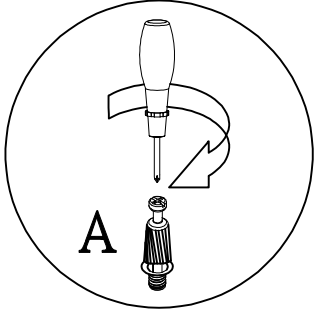
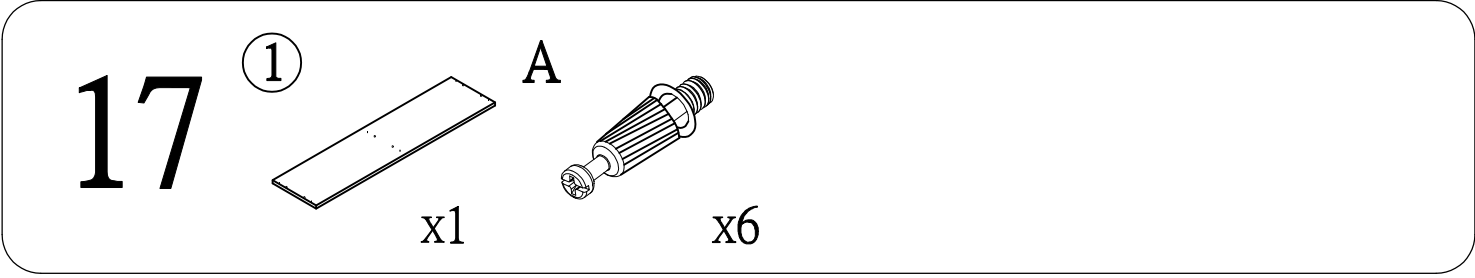

# 18

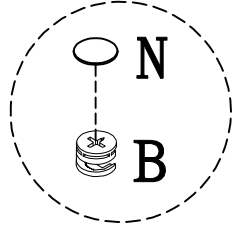
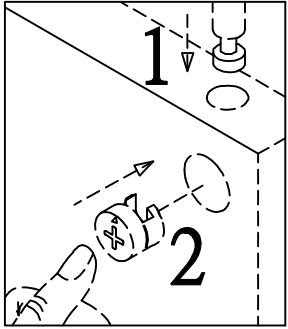
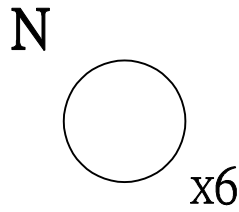
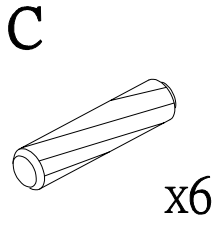
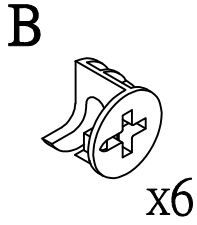

(B) After the eccentric wheel is locked on the plate, use (N) hole sticker to cover it

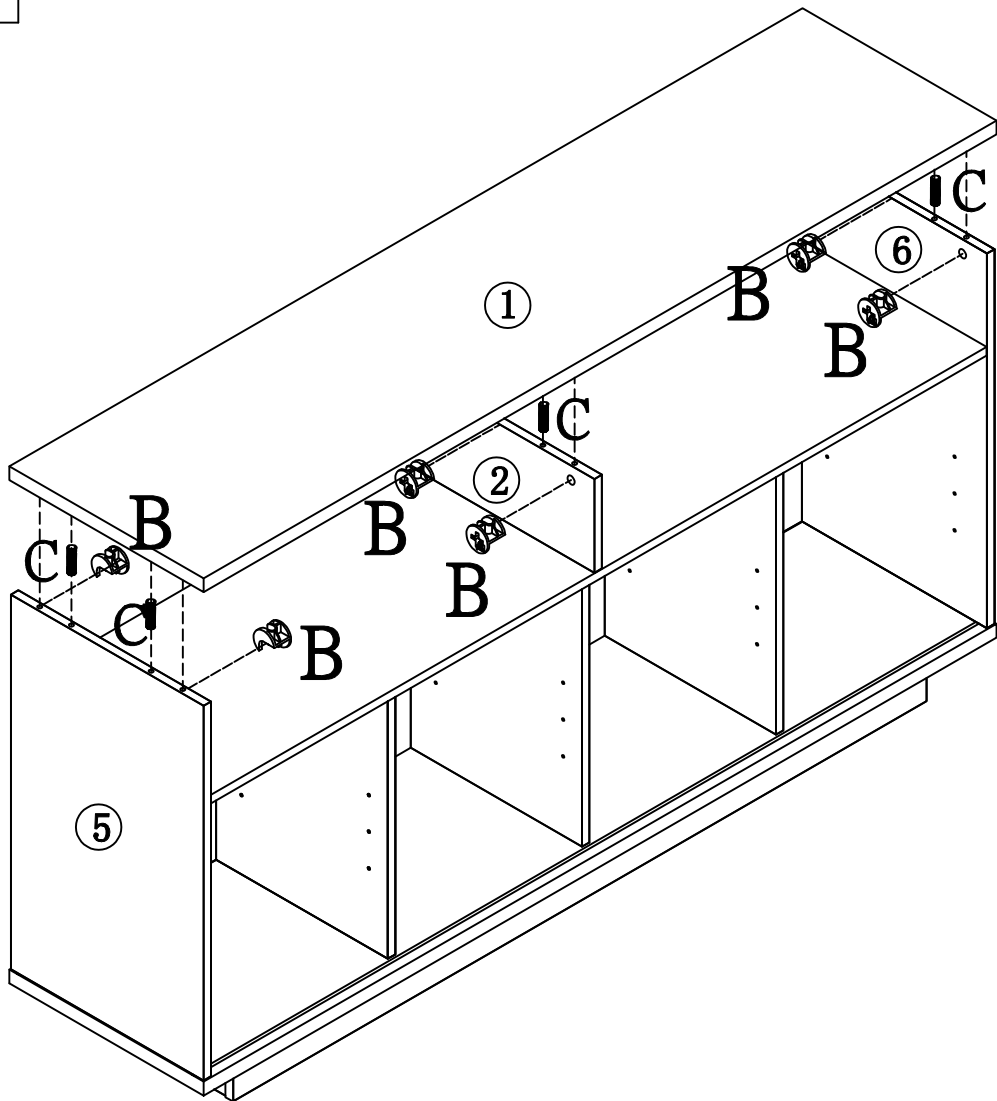
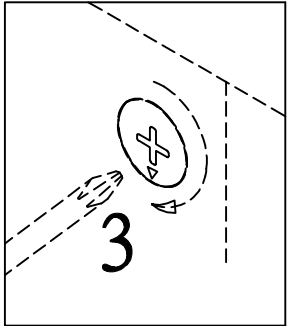

# 19

J

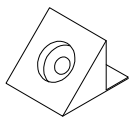

x8

K



x8

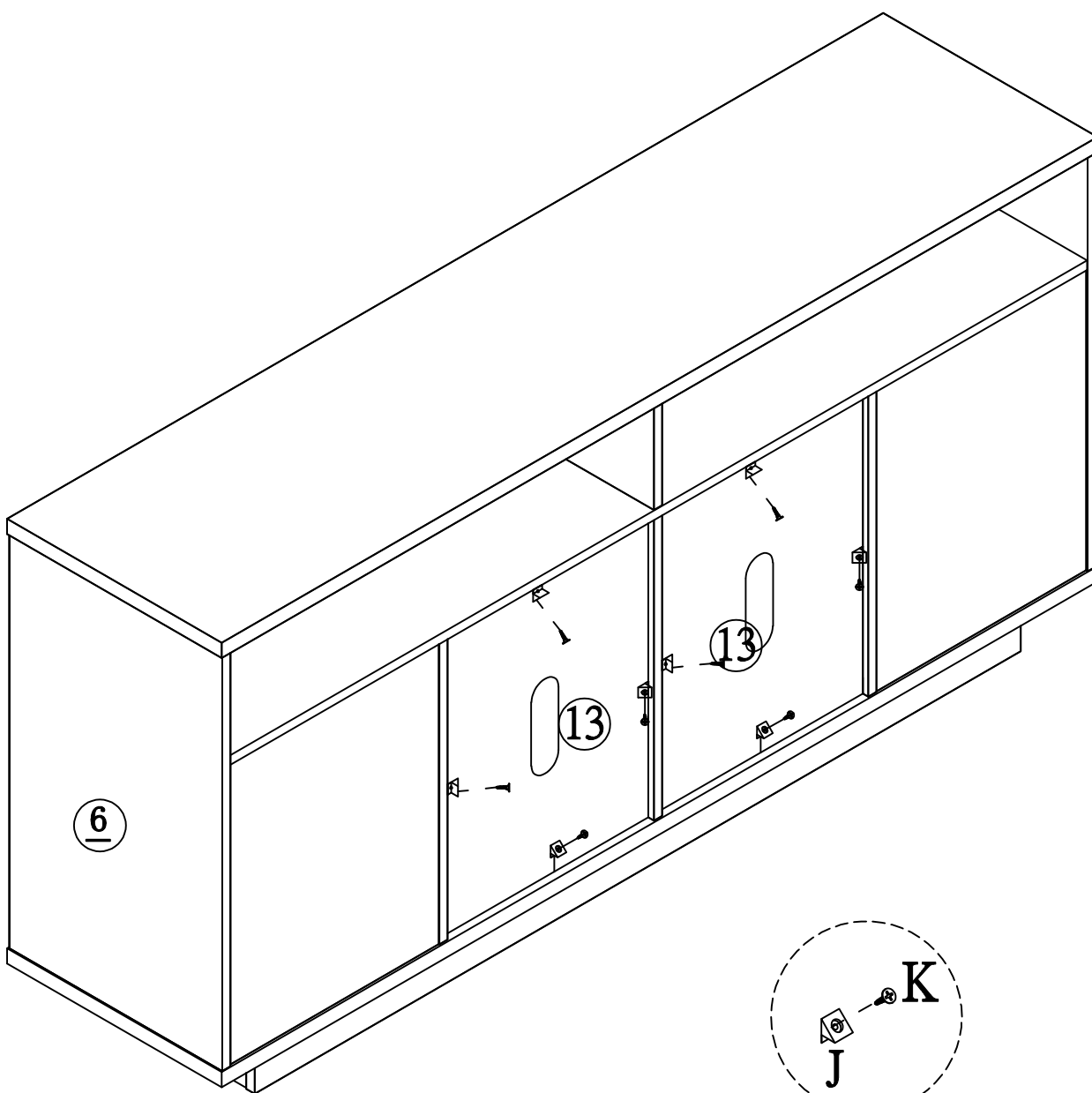

20

⑩

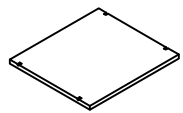

x2

⑪

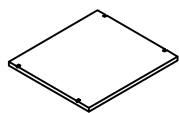

x2

G

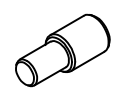

x16

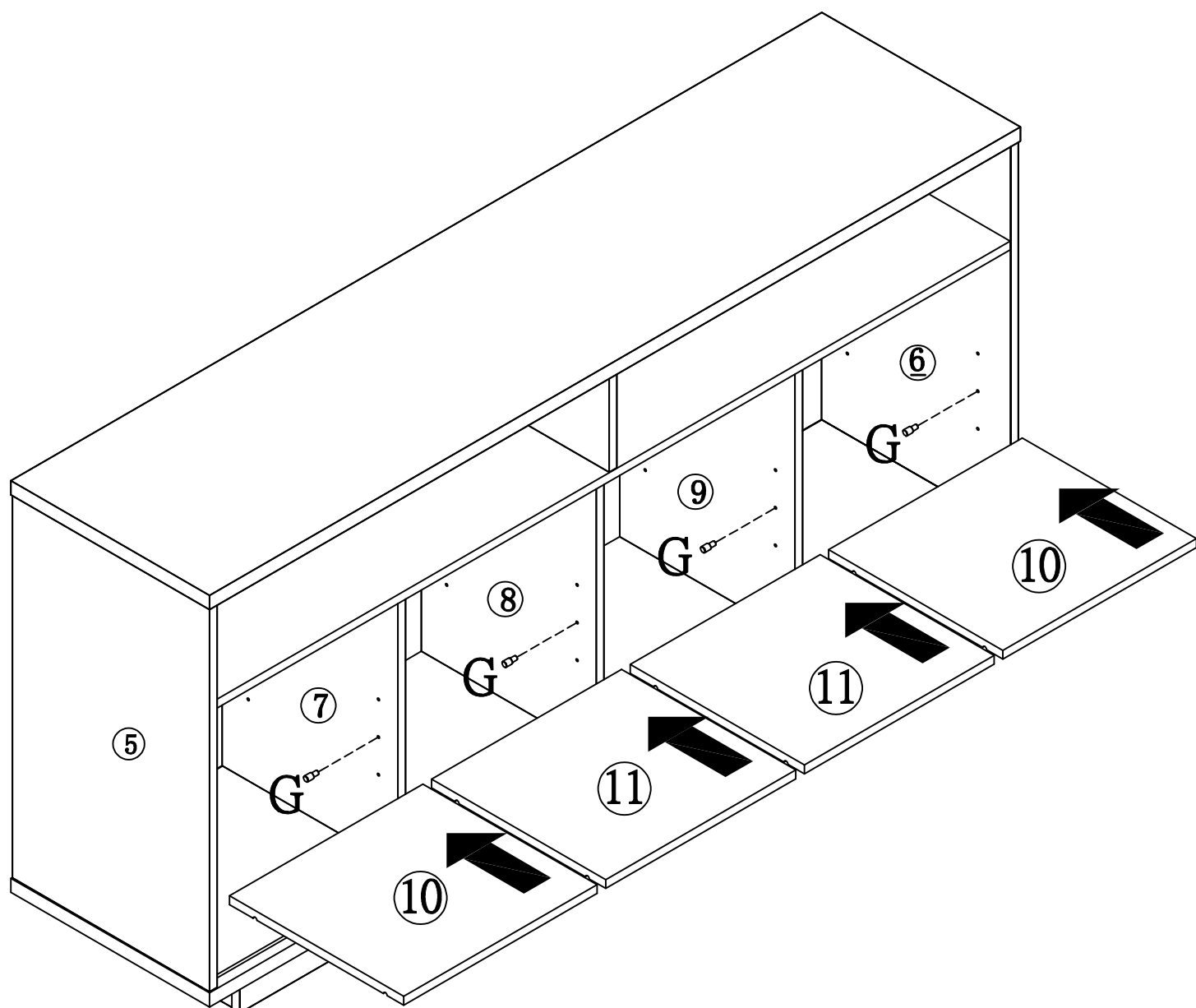

# 21

⑭

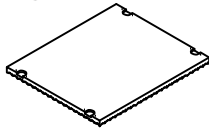

x1

⑮

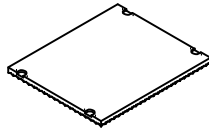

x1

E



x4

F



x4

L



x16

⑭

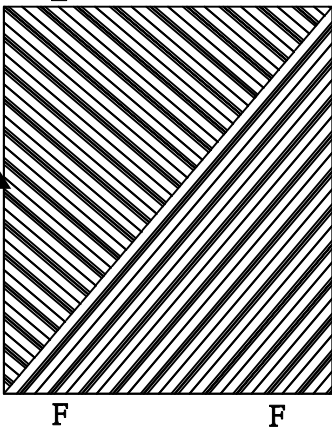

⑮

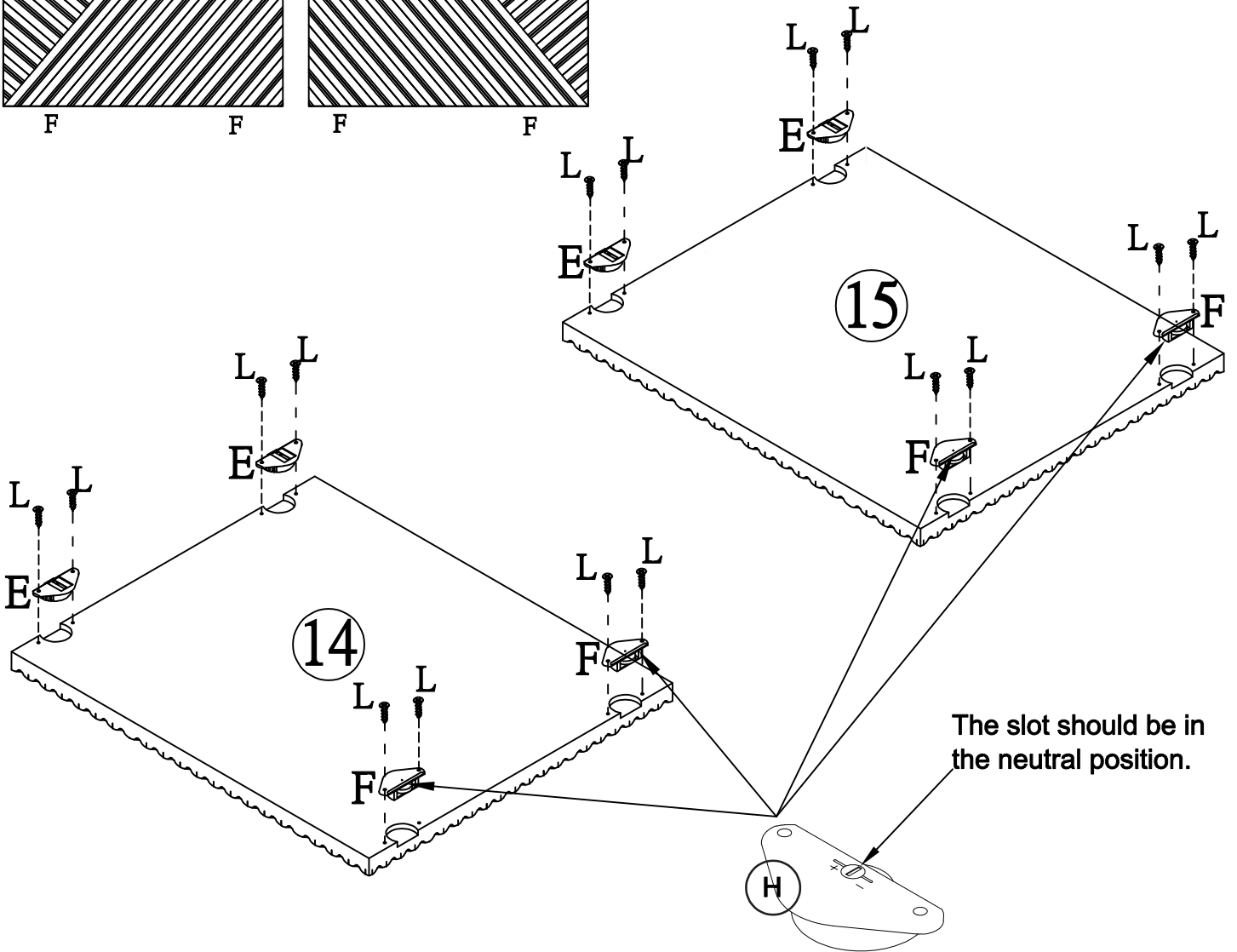
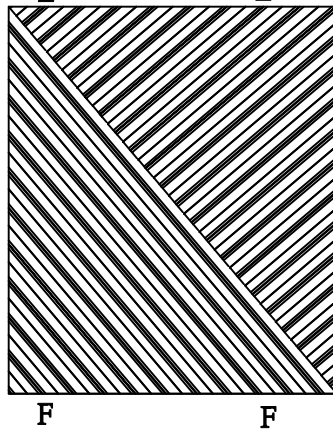

The slot should be in the neutral position.

# 22

⑭

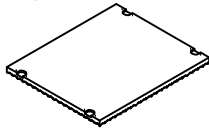

x1

⑮

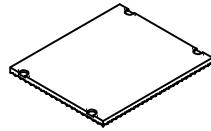

x1

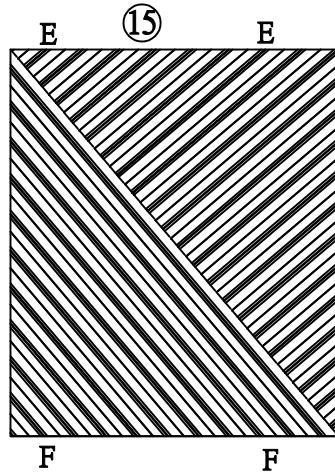
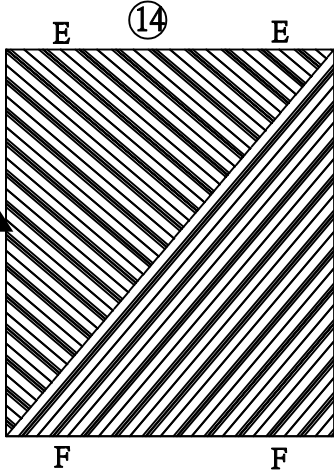

The tab should be down before you insert it into the upper track.

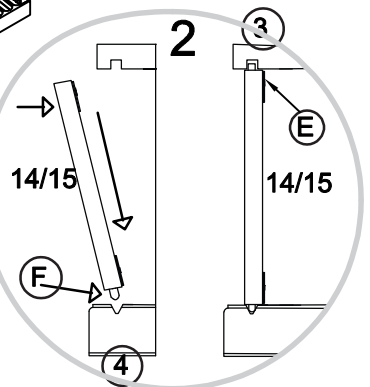
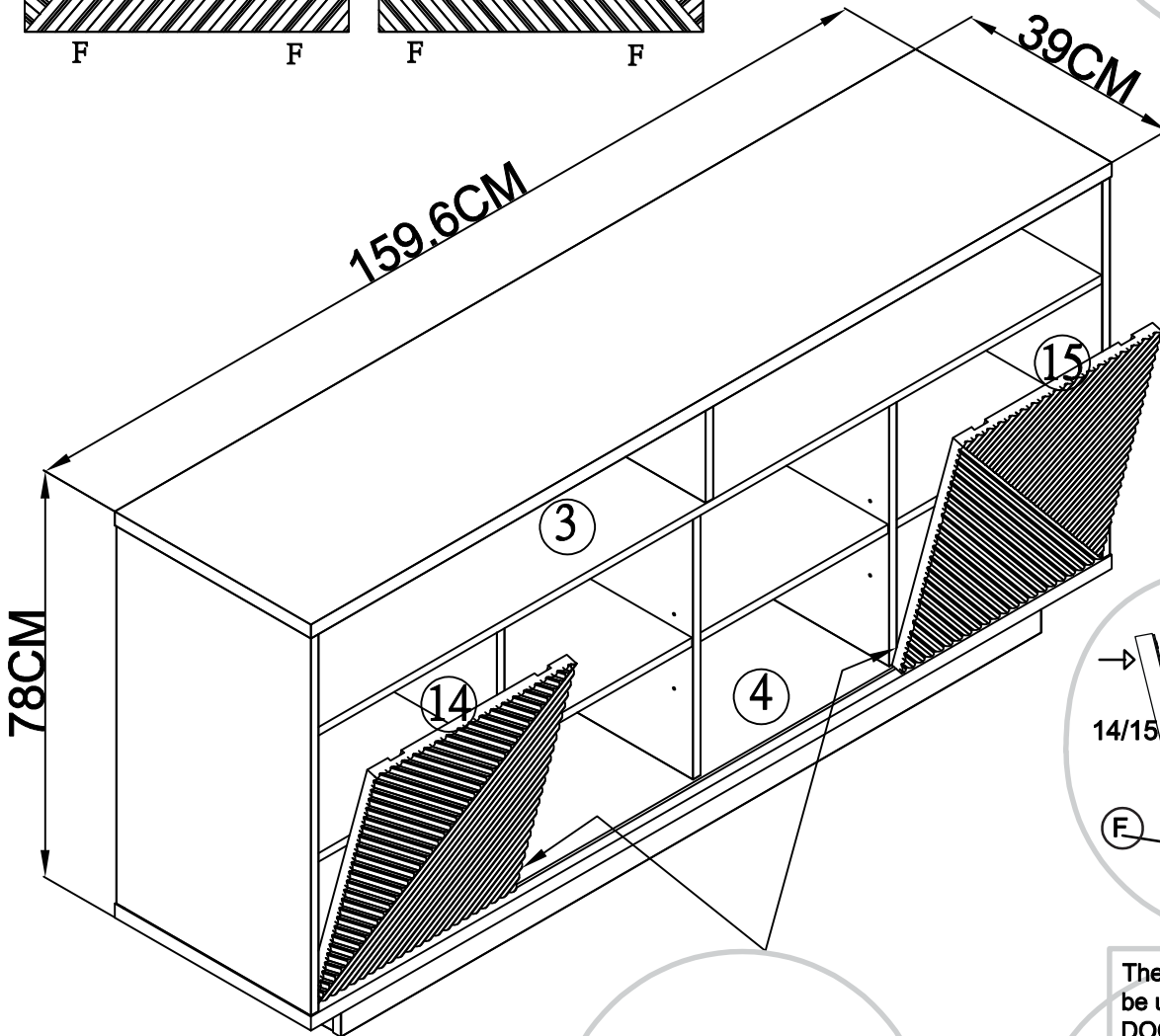
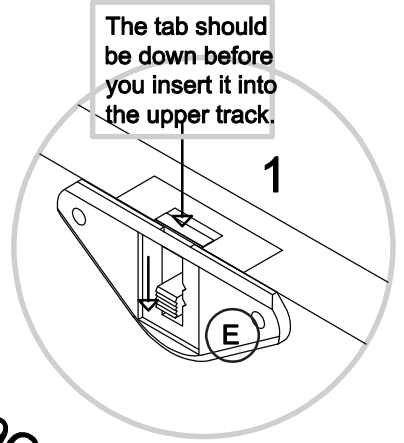

The tab should be up after the DOOR is in place.

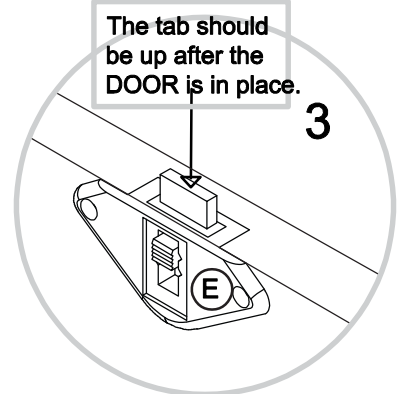

4

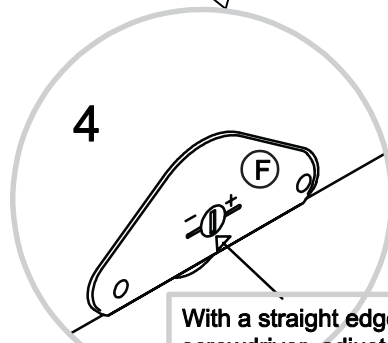

With a straight edge screwdriver, adjust the door up or down.

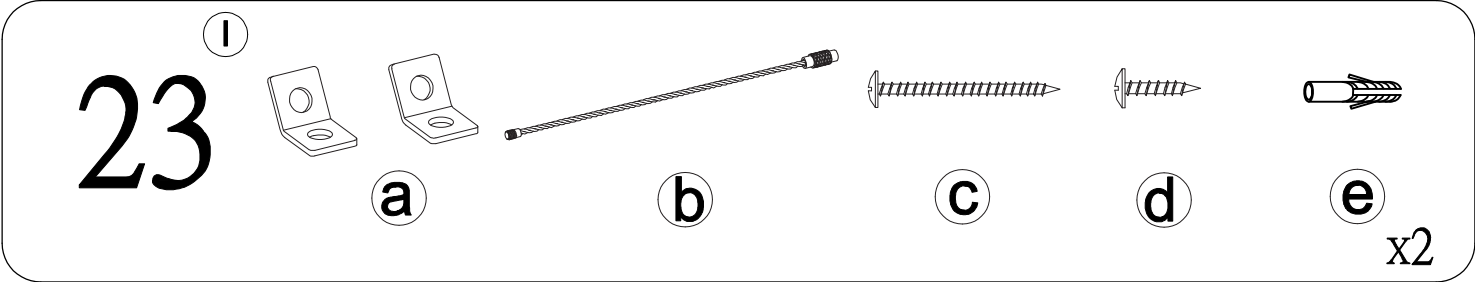

**WARNING**

Serious or fatal injuries can occur from furniture tipping over. To prevent the furniture from tipping over we recommend that it is permanently fixed to the wall. Wall anchor and hardware are included with this product. Please make sure hardware is suitable for your walls before installing, as different wall materials may require different types of anchors.

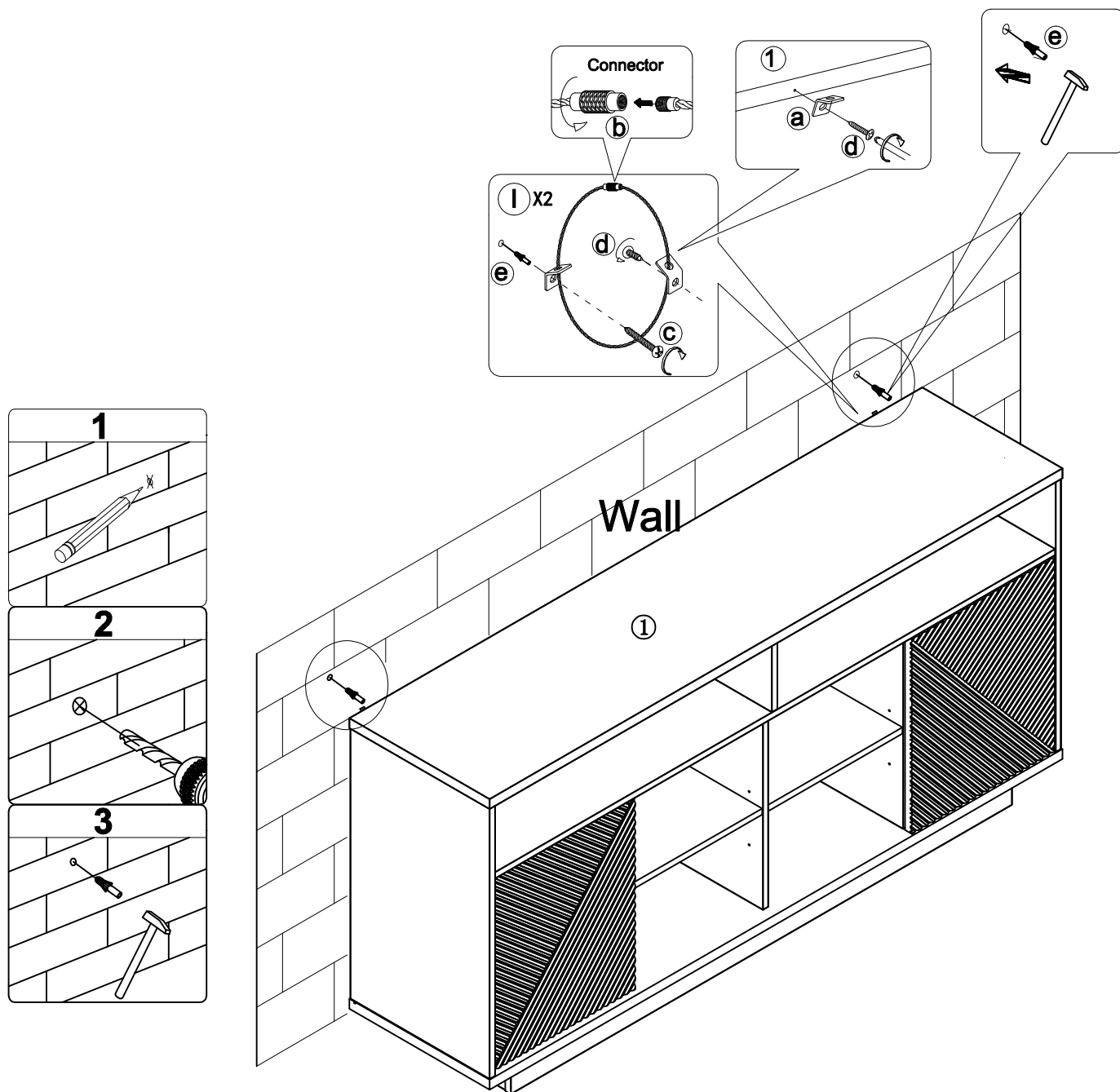

# Warranty Information

Thank you for purchasing our furniture. We are committed to delivering high-quality furniture that meets your expectations. This product comes with a 1-year limited warranty covering defects in materials and workmanship under normal use from the date of purchase.

## Warranty Coverage

Structural damage or defects in the wood panels.

Malfunction of hardware components such as hinges or screws.

Any damage caused during transit that affects product functionality.

## Exclusions

Damage caused by improper assembly or modifications.

Issues caused by external factors such as moisture or extreme temperatures.

In case of any warranty claims, please contact our customer service team with your proof of purchase and a detailed description of the issue.

---

## Quality Assurance (QA) & Common After-Sales Issues

We take pride in our rigorous quality assurance process to ensure every piece of furniture meets high standards. However, we understand that issues may arise. Below are some of the common after-sales concerns and their potential solutions:

### Gaps Between Panels

If there are visible gaps between the panels, please check the assembly process to ensure all parts are securely fastened. If the issue persists, contact our customer service for assistance.

### Misaligned Doors

In case the doors are not aligned properly, adjustments to the hinges may be needed. Instructions for adjusting the hinges are included in the manual. If adjustments do not resolve the issue, please contact us.

### Shipping Damage

If your furniture arrives with any damage from shipping, such as dents or scratches, please report the damage immediately. We will arrange for a replacement or repair.

### Incorrect Hole Alignment

If any holes for assembly are misaligned, please refrain from forcing the components together. Contact our customer service for troubleshooting or part replacement.

# Thank You!

*For Purchasing from us*

Despite our reinforced packaging, transit mishandling can sometimes occur. In the rare event that your product arrives damaged, we're here to assist you. If your product is in perfect condition, you can disregard this message.

If you discover any damage upon receipt of your package, please contact our after-sales mailbox immediately at [care@oakhamdesign.com](mailto:care@oakhamdesign.com).

Additionally, we kindly request your assistance in filing a claim against the shipping carrier for the mishandling of your package. Please help us by providing clear photos as follows:

- ★ **Complete Shipping Label (Express Delivery Waybill):** Take a clear image of the entire shipping label affixed to the package with visible and legible text and barcodes
- ★ **Exterior Packaging Damage:** Capture a comprehensive photo showing the damaged exterior of the shipping package.
- ★ **Interior Item Damage:** Provide images focusing on the damaged areas of product

Your cooperation is invaluable, and we assure you that we're committed to resolving this issue promptly. Your satisfaction remains our top priority.

Thank you for your understanding and assistance.  
Best regards,

Oakham Customer Support Team  
**[care@oakhamdesign.com](mailto:care@oakhamdesign.com)**



Scan to  
Watch Installation Video

---

Video instructions can be found at:

<https://oakhamdesign.com/pages/assembly-videos>

Your satisfaction is our priority!

If for any reason there is anything missing, incorrect, or different from your expectation, please contact us first at [care@oakhamdesign.com](mailto:care@oakhamdesign.com)

TEL:1+(888)636-1997  
made in China



[www.oakhamdesign.com](http://www.oakhamdesign.com)