

ASSEMBLY INSTRUCTIONS

FULL BED WITH HEADBOARD

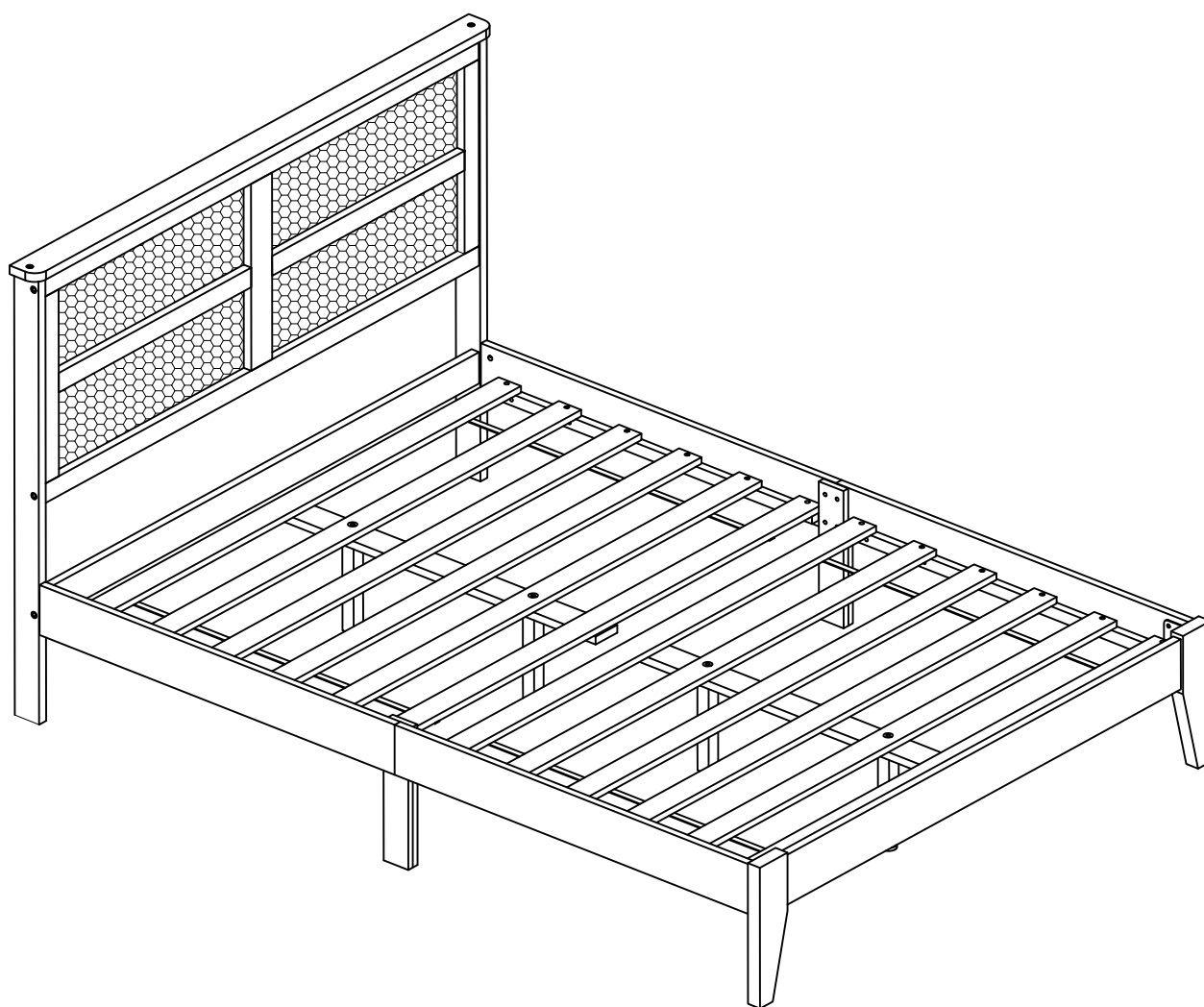





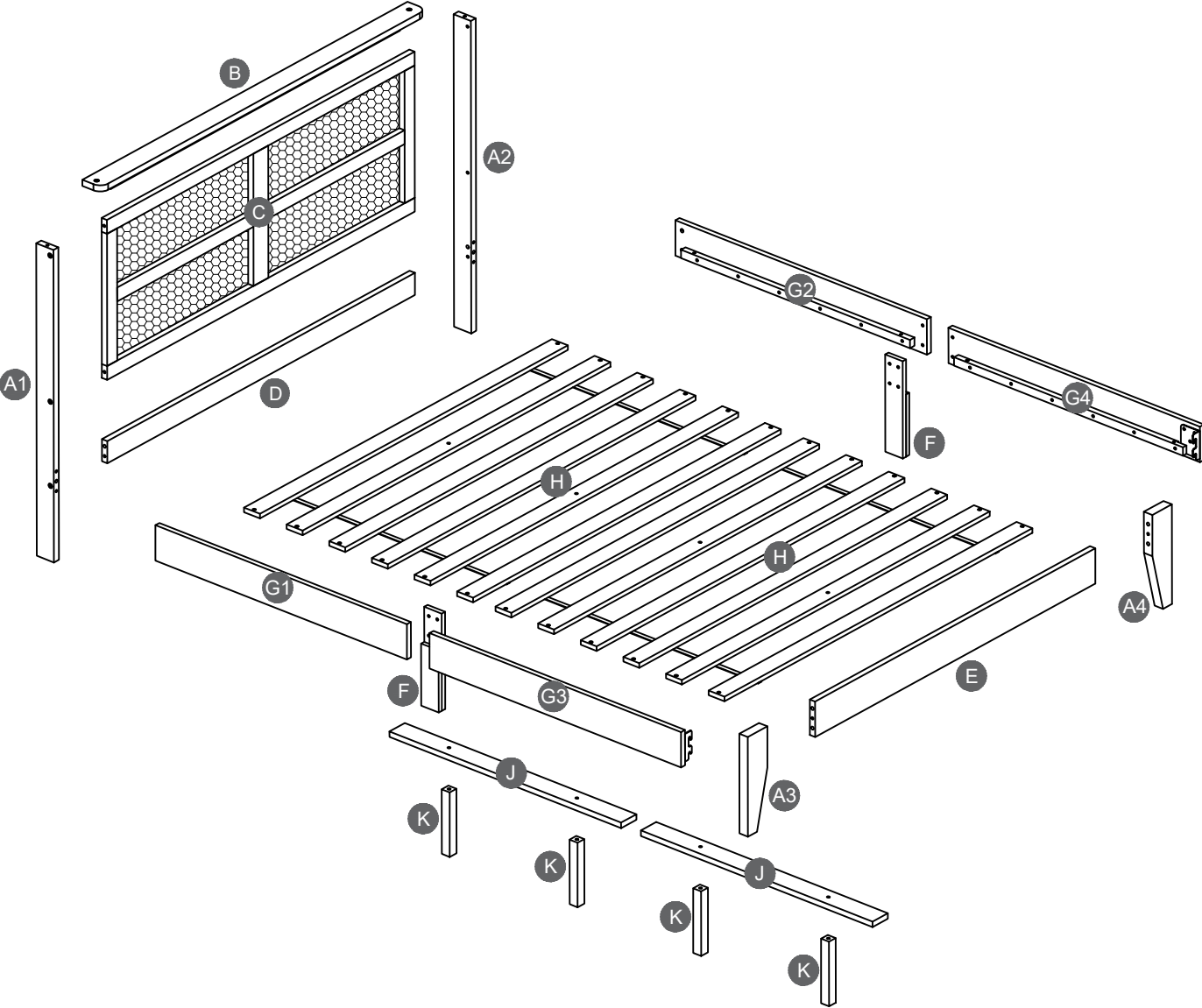

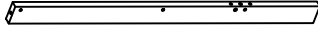
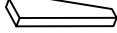

MK62015

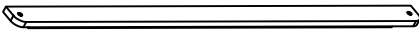
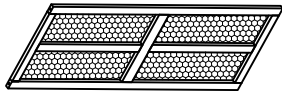

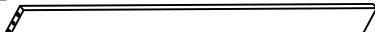

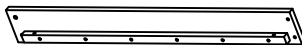
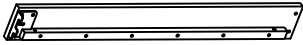

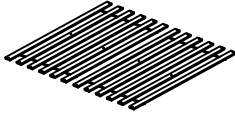
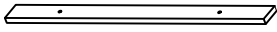
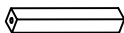



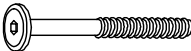

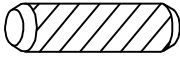

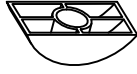
Detail View

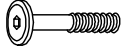

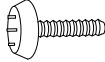
Part List

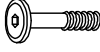
A1  Leg (Headboard Left) - 1pc	A2  Leg (Headboard Right) - 1pc	A3  Leg (Footboard Left) - 1pc
A4  Leg (Footboard Right) - 1pc	B  Top Panel (Headboard) - 1pc	C  Middle Panel (Headboard) - 1pc
D  Bottom Panel (Headboard) - 1pc	E  Panel (Footboard) - 1pc	F  Side Rail Support (Left & Right) - 2pcs
G1  Side Rail Left (Headboard) - 1pc	G2  Side Rail Right (Headboard) - 1pc	G3  Side Rail Left (Footboard) - 1pc
G4  Side Rail Right (Footboard) - 1pc	H  Bed Slats - 2Sets	J  Center Rail - 2pcs
K  Support Leg - 4pcs		

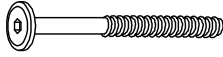
Hardware List

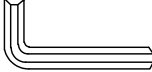

1  M6 x 60mm JCBC (8pcs)	2  M6 x 15mm Barrel Nut (10pcs)	3  M10 x 30mm Wood Dowel (8pcs)
4  M6 x 40mm JCBC-W (2pcs)	5  M4 x 32mm CSK Screw (3pcs)	6  M6 Half Moon Nut (2pcs)
7  Flat Washer (2pcs)	8  Split Lock Washer (2pcs)	9  M6 x 30mm JCBC (8pcs)
10  M6 x 30mm JCBC-W (8pcs)	11  M4 x 25mm CSK Screw (16pcs)	12  Adjustable Screw (4pcs)
13  Flat Washer (8pcs)	14  M6 x 110mm JCBC (4pcs)	15  M8 x 20mm JCBB (4pcs)
16  Sticker Cap (8pcs)	17  M8 Flat Washer (4pcs)	18  M8 x 80mm JCBB (4pcs)
19  M4 Allen Key (1pc)	20  M5 Allen Key (1pc)	

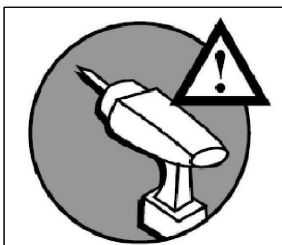
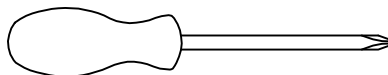
ASSEMBLY TOOLS REQUIRED (NOT INCLUDED)



PLEASE BE CAREFUL DO NOT DAMAGE THE HOLE POSITION WHEN YOU USE POWER TOOLS !

STEP 1:

1		2		3	
6PCS		6PCS		2PCS	

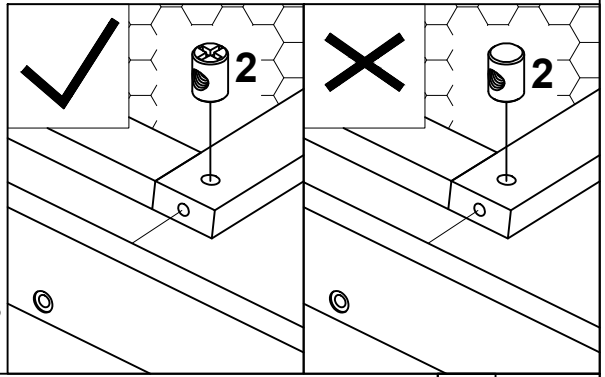
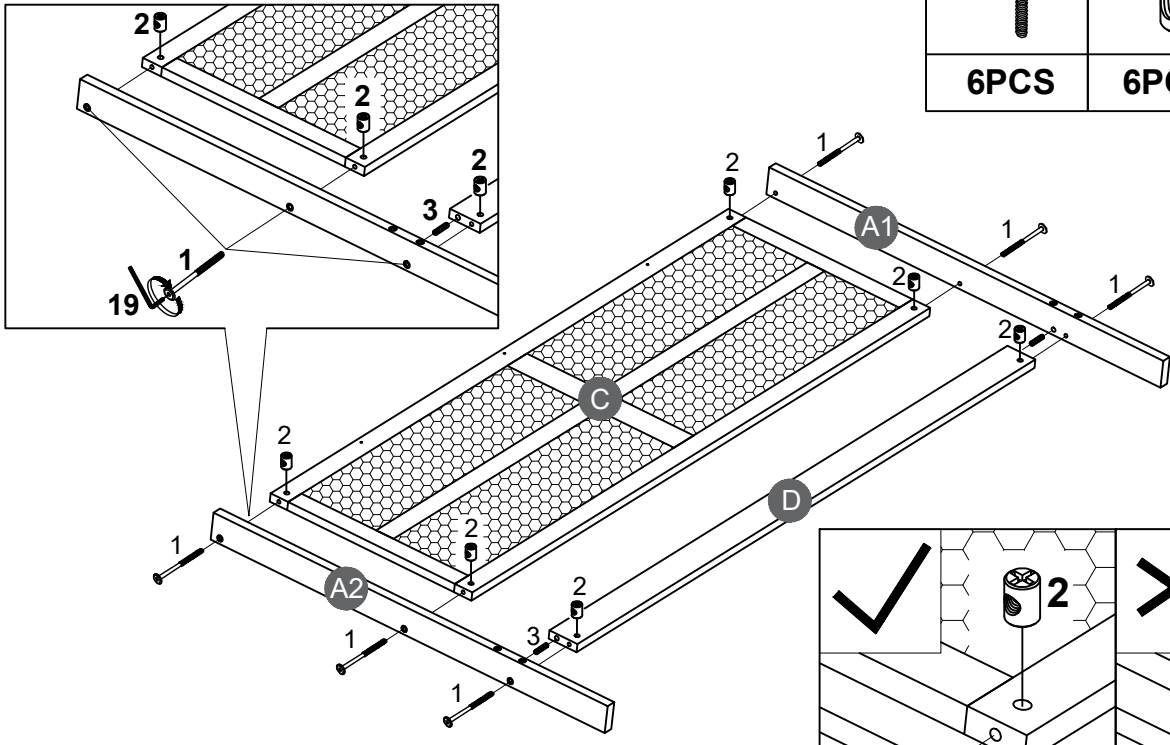

Note: Part 2 will face up with the "x" mark on it, otherwise it cannot be tightened

STEP 2:

4	
2PCS	

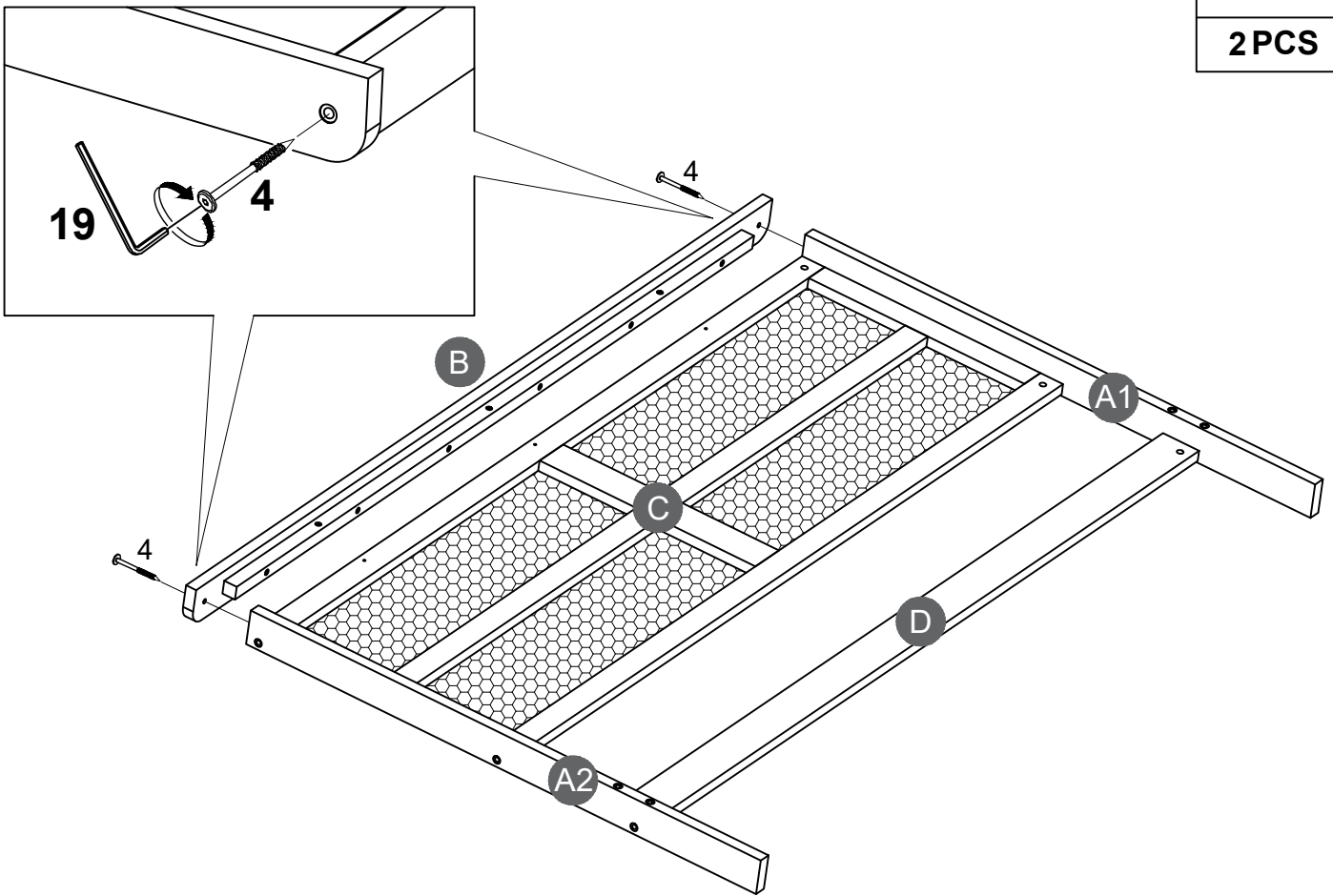

STEP 3:

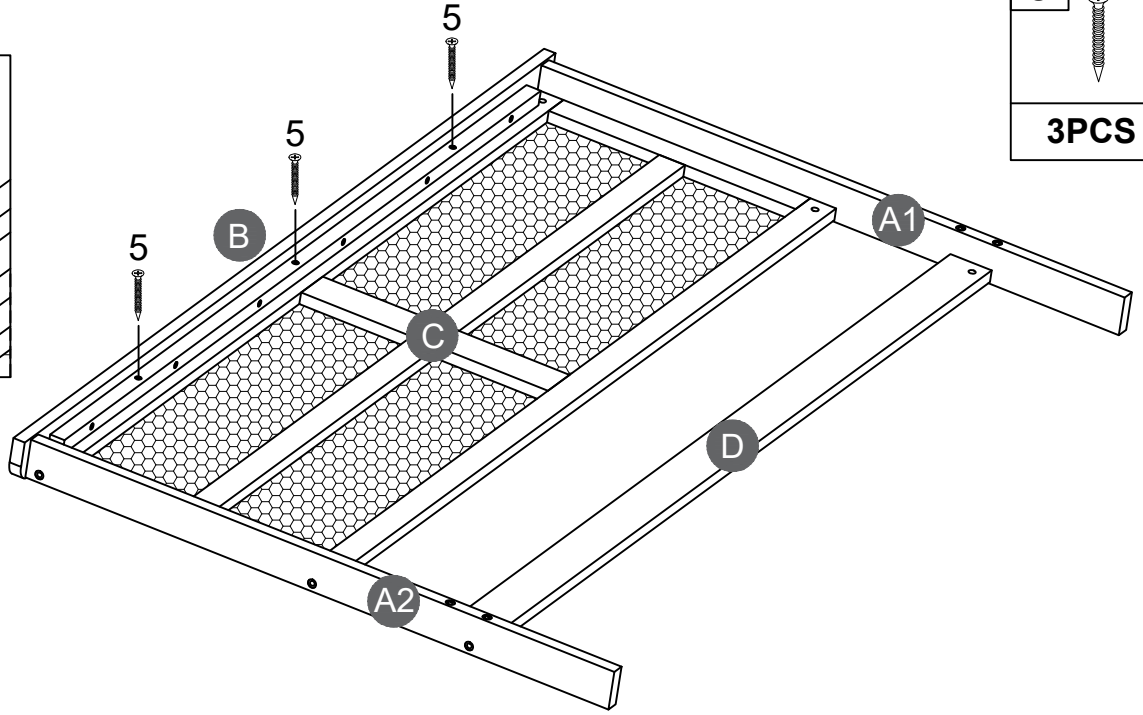
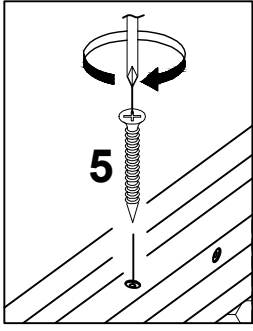



5	
3PCS	

STEP 4:

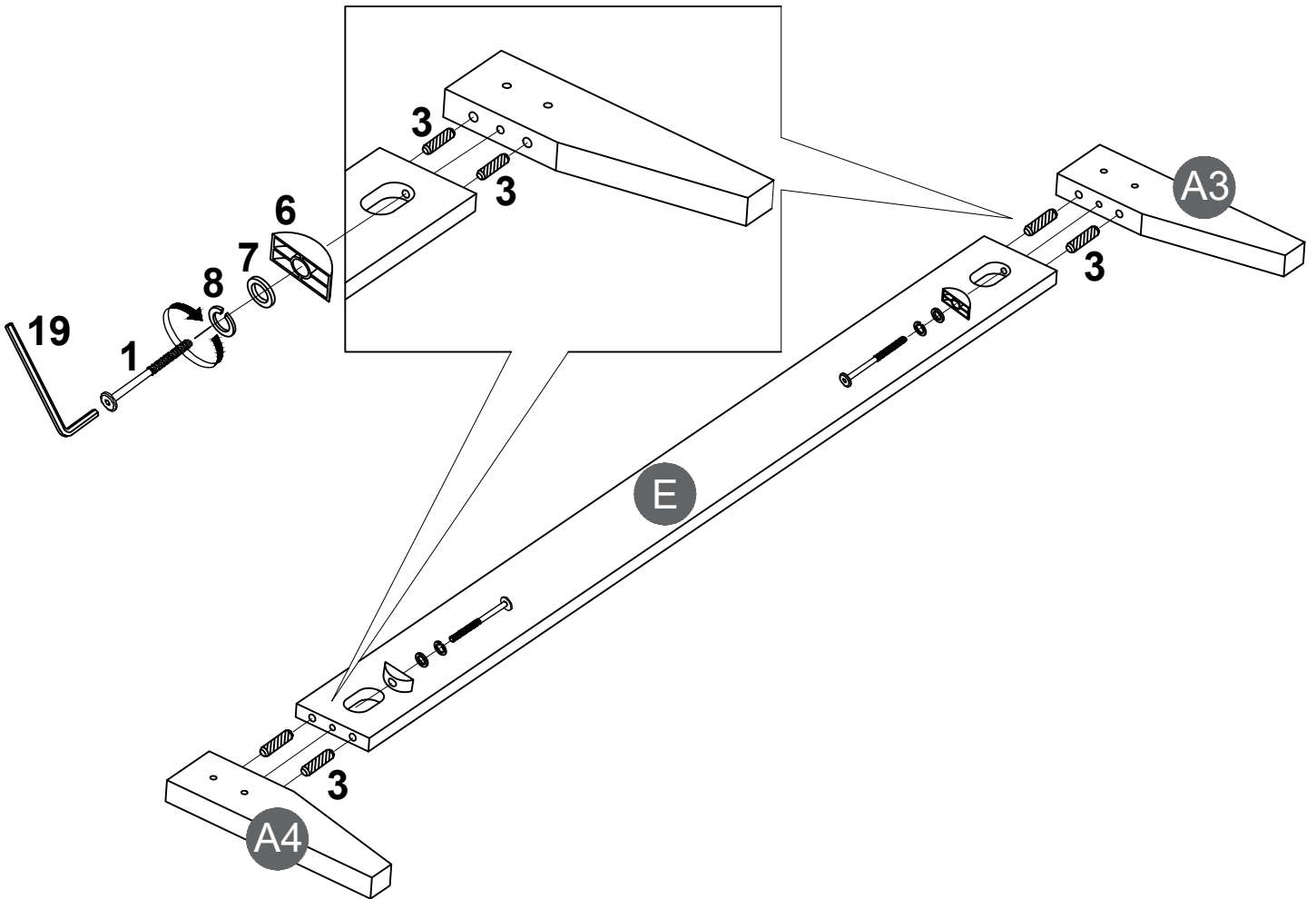
1		3		6		7		8	
2PCS		4PCS		2PCS		2PCS		2PCS	





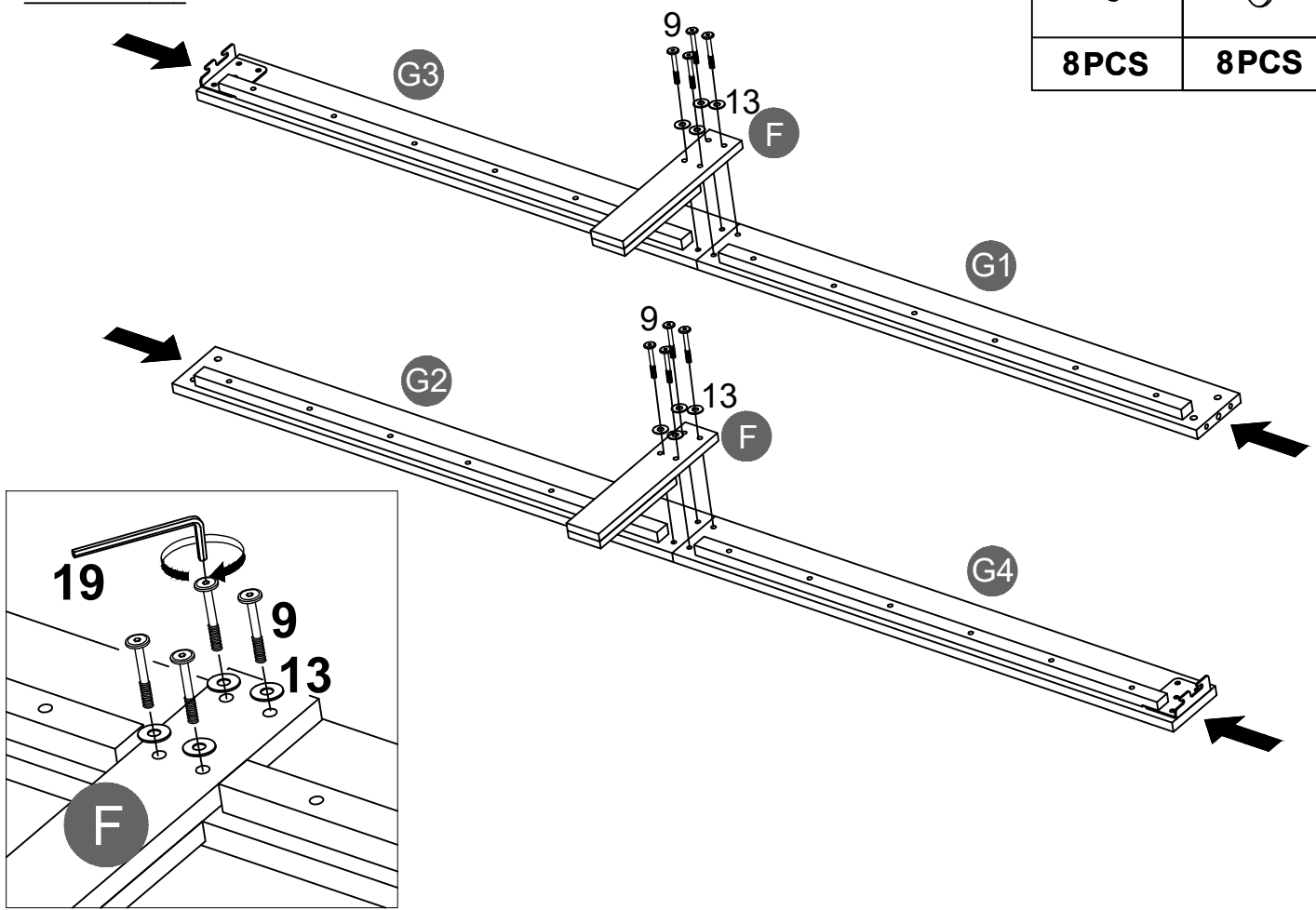

STEP 5:

9		13	
8PCS		8PCS	



STEP 6:

2		3		14		15	
4PCS		2PCS		4PCS		4PCS	

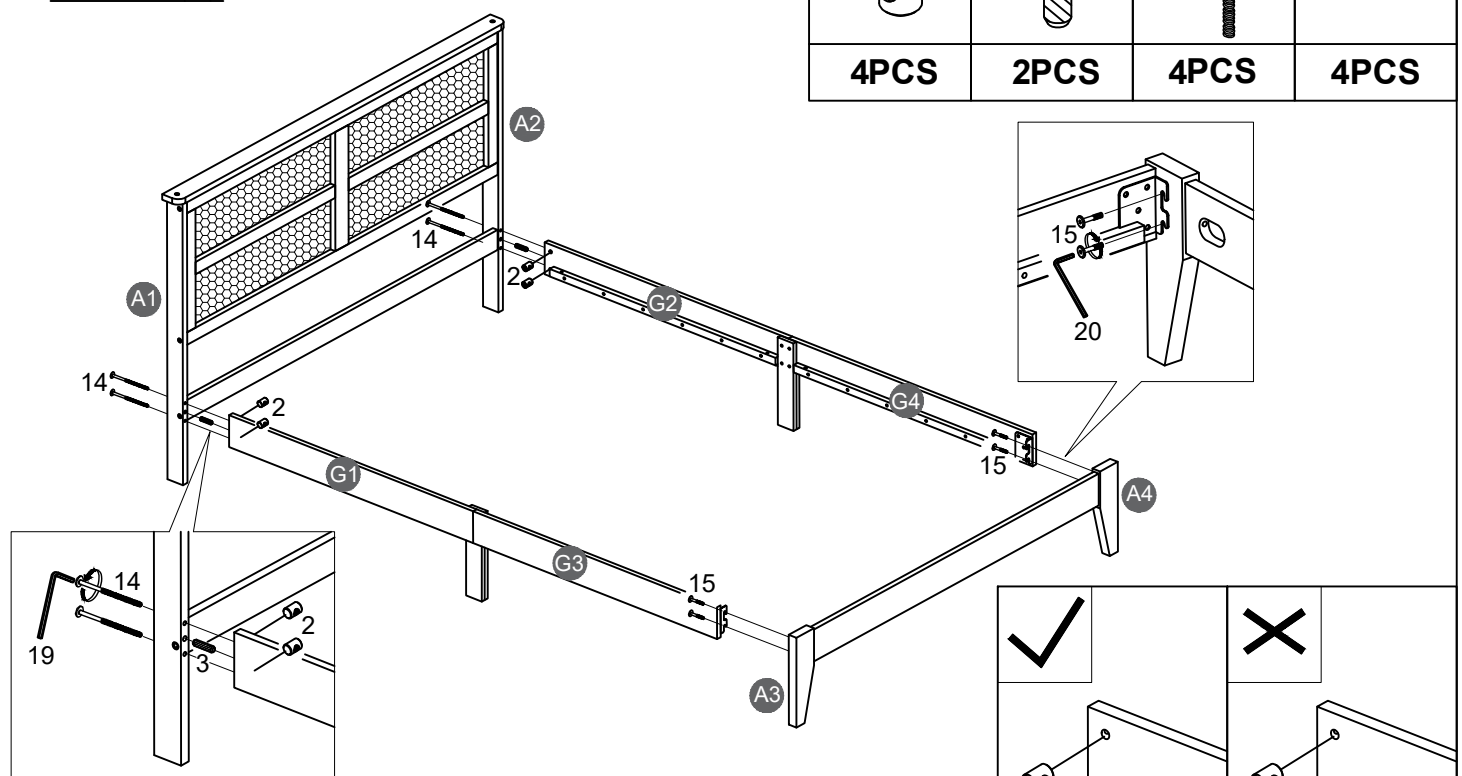



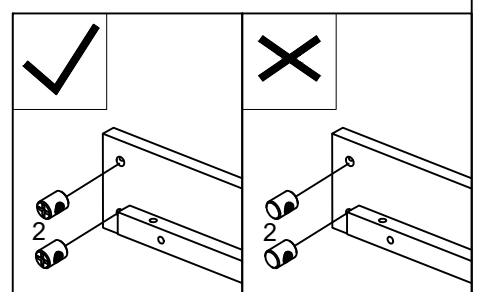

Note: Part 2 will face up with the "x" mark on it, otherwise it cannot be tightened

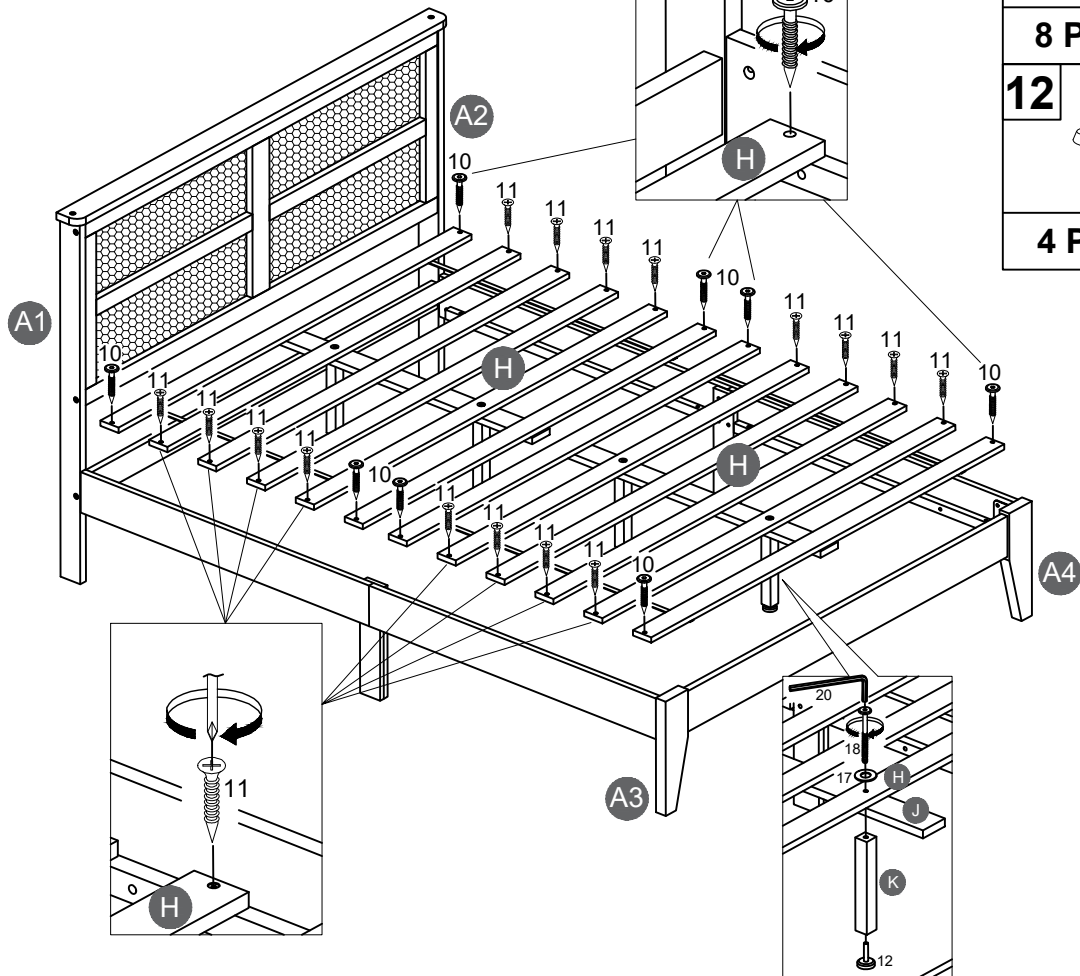



STEP 7:

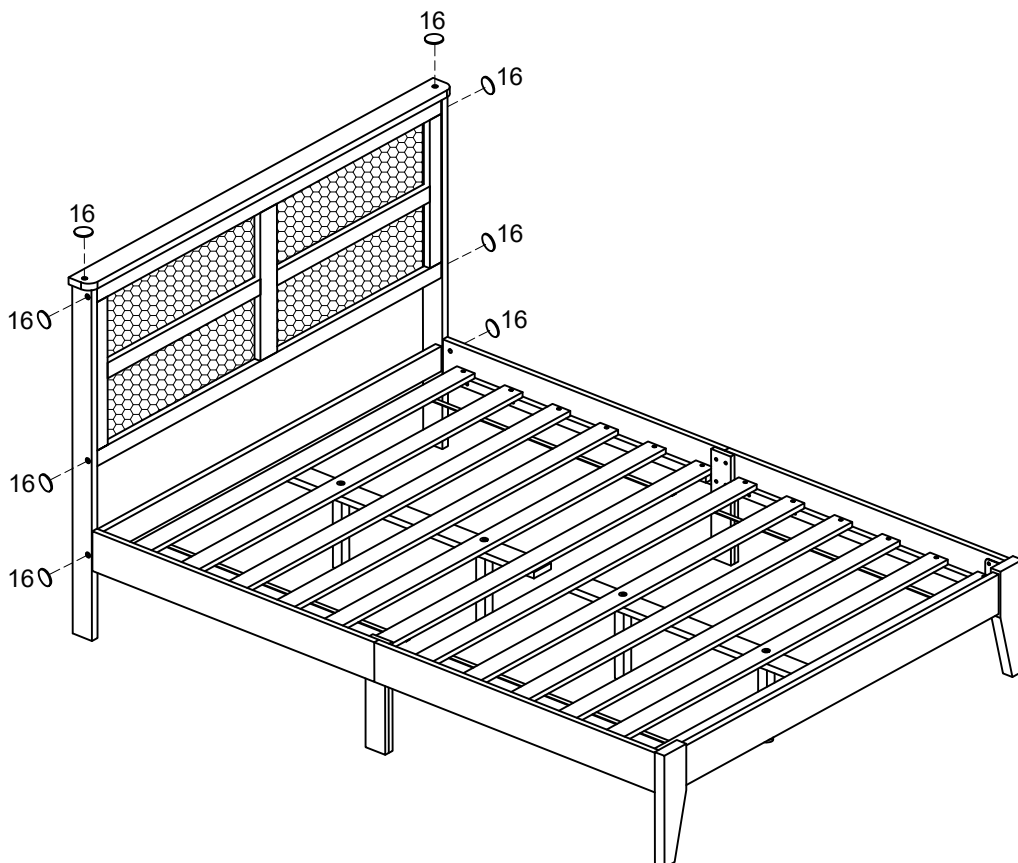

10 	11 
8 PCS	16 PCS
12 	17 
4 PCS	4 PCS
18 	
4 PCS	

STEP 8:



16 
8 PCS