



CAP60ROAKMR

A

A

B

B

C

C

D

D

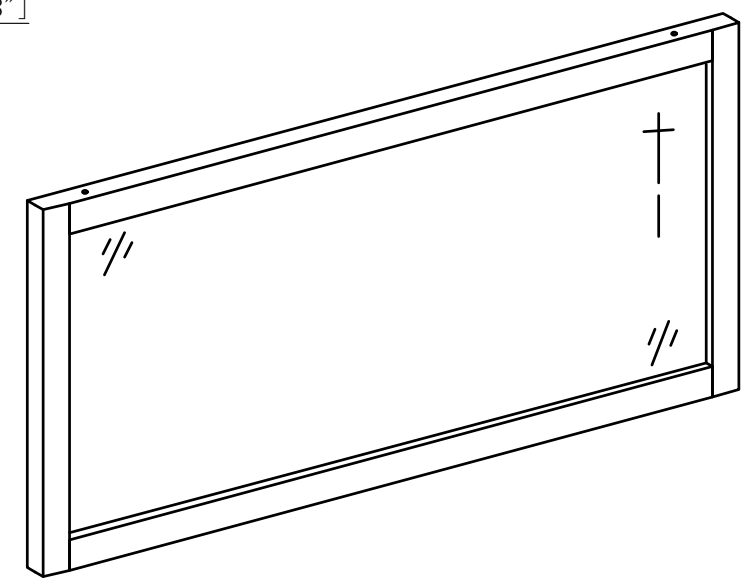
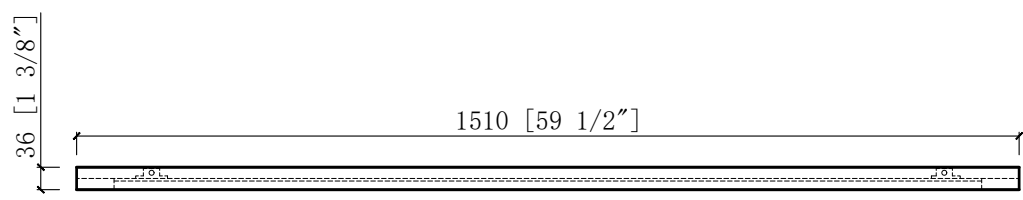
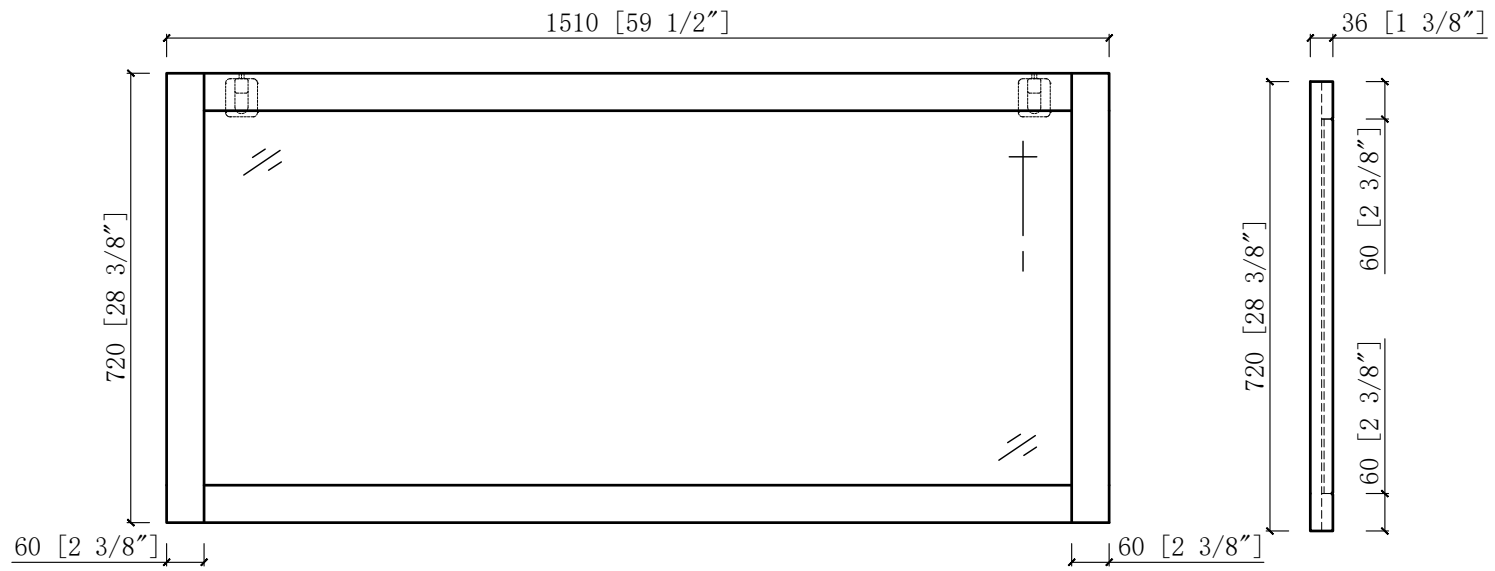

1

2

3

4

5

6