

Installation Guide & User Manual

Version: C02

Classic Series
Under Cabinet Range Hoods
Models: 6" High, 6" Top Vent or 3-1/4" x 10"
RECTANGLE TOP / REAR VENT OPTIONS
0.7mm Thickness

RANGE HOOD



STOP and read! Test before installing

1. Please unpack the range hood and accessories carefully.
2. Remove the aluminium filters, check any dent or damage inside and outside.
3. If found any loosing parts, please remove them.
4. Place the range hood on a flat stable surface, plug in 120V AC power source. Press the power button and the speed buttons to turn on.
5. Check if any unusual metal touching noise, check the speed variation, and press the Light button to check the lights.
6. Verify all functions per Section 9 RANGE HOOD OPERATIONS.
7. Refer to Section 10 TROUBLESHOOTING if any malfunction was found.
8. The plastic protective film was removed for sanding polish finishing.

IMPORTANT:

Read and save these instructions.

NOTICE:

Installer: Leave this guide with the homeowner
Homeowner: Keep this guide for future reference



BAFFLE FILTER



HIGH AIRFLOW



POWERFUL MOTOR



LOW NOISE OPERATION



Contact your local seller for exchange or repair.
Email to amazon: rangehoodservice06@163.com
or others: rangehoodservice10@163.com for technical support and sales activity.



PLEASE READ AND SAVE THESE INSTRUCTIONS.

Strongly recommend to test the unit before installation for any defective or damage during shipment.

WARNING – TO REDUCE THE RISK OF FIRE, ELECTRIC SHOCK, OR INJURY TO PERSONS, READ THE FOLLOWING CAREFULLY before attempting to assemble, install, operate or maintain the product.

- A. Always disconnect, lock and tag power source before installing or servicing product. Failure to disconnect power source can result in fire, shock or serious injury.**
- B. Installation work and electrical wiring must be done by qualified person(s) in accordance with all applicable codes and standards, including fire-rated construction.**
- C. When cutting or drilling into wall or ceiling, do not damage electrical wiring and other hidden utilities.**
- D. Verify and ensure the rated voltage and frequency (please refer to the rating label) of the range hood is in compliance with the mains supply.**

1. KNOW BEFORE INSTALLATION

Research, plan and prepare the optional accessories & tools.

Duct venting and accessories (NOT INCLUDED)

- If for new installation or your old range hood doesn't have exhaust duct, prepare to cut the openings through the bottom of the cabinet, wall, or top cabinet to ceiling. And purchase the 6" metal duct (or 6" semi-rigid aluminum duct for easy connection). Refer to Section 5 VENTING METHODS for detail.
- Check the existing exhaust duct size. If not 6" round metal duct, try to get the converter / reducer / adapter / elbow as shown in the pictures.

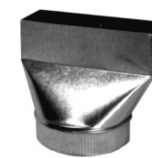

- Damper is NOT included. Because the damper generates NOISE when the shutters are flipping, we DO NOT recommend installing the damper directly attached to the top vent of the range hood. You can install the damper between ducts and close to the air outlet near roof or side wall. If the roof cap or side wall cap already has a damper, don't need to add the damper.



- Also prepare the cutting tools (jig saw or reciprocating saw), screw drivers or power drill, level, measuring tape, knife, duct/foil tape, screws, marker/pencil, etc.



- 2 people are required for the installation.

2. INCLUDED PARTS & ACCESSORIES

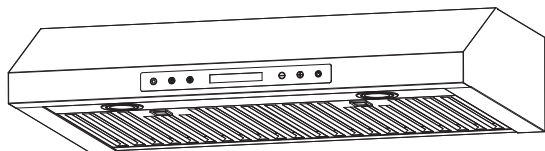
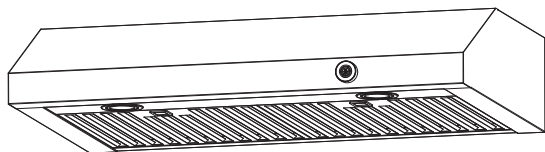
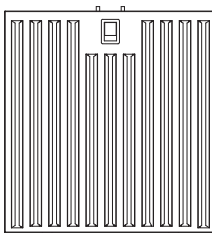
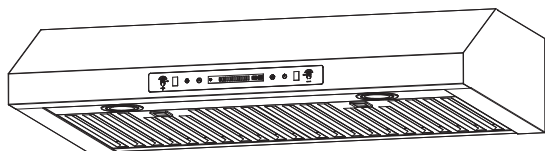
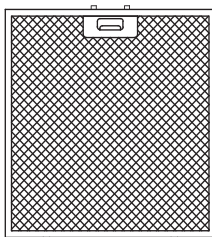
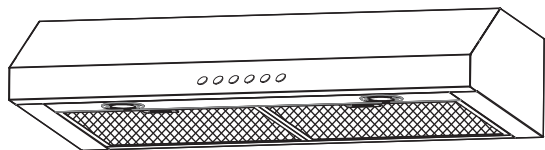

Note: the supplied are subjected to change without notice due to product development.

3. IMPORTANT SAFETY NOTICE

Read all Instructions before Installing and operating this appliance

Installation Cautions

- The installation in this manual is intended for qualified installers, service technicians or persons with similar qualified background. Installation and electrical wiring must be done by qualified professionals and in accordance with all applicable codes and standards, including fire-rated construction.
- **DO NOT** attempt to install this appliance yourself. Injury could result from installing the unit due to lack of appropriate electrical and technical background.
- Range hood may have very sharp edges; please wear protective gloves if it is necessary to remove any parts for installing, cleaning or servicing.
- **Before installation, turn on the range hood to test for any damage / defect due to shipping.**
- Due to the size and weight of this range hood, two people installation is required.

To reduce the risk of fire, electric shock, or injury to persons:

- For general ventilating use only. **DO NOT** use to exhaust hazardous or explosive materials and vapors.
- The combustion air flow needed for safe operation of fuel-burning equipment may be affected by this unit's operation. Follow the heating equipment manufacturer's guideline and safety standards such as those published by the National Fire Protection Association (NFPA), and the American Society of Heating, Refrigeration and Air Conditioning Engineers (ASHRAE), and the local code authorities.
- Before servicing or cleaning unit, unplug the power cord or switch power OFF at service panel and lock service panel to pre-vent power from being switched ON accidentally.
- Clean grease laden surfaces frequently. To reduce the risk of fire and to disperse air properly, make sure to vent air outdoors. **DO NOT** vent exhaust into spaces between walls, crawl spaces, ceiling, attics or garages.
- Use only metal ductwork and this unit **MUST** be grounded.
- Sufficient air is needed for proper combustion and exhausting of gases through the duct to prevent back drafting.
- When cutting or drilling into wall or ceiling, be careful not to damage electrical wiring or other hidden utilities.
- All electrical wiring must be properly installed, insulated and grounded.
- Old duct work should be cleaned or replaced if necessary to avoid the possibility of a grease fire.
- Check all joints on duct work to insure proper connection and all joints should be properly taped.
- Use this unit only in the manner intended by the manufacturer. If you have questions, contact the vendor.

To reduce the risk of a stove top grease fire:

- Keep all fan, baffle, spaces, filter, grease tunnel, oil container and grease-laden surfaces clean. Grease should not be allowed to accumulate on fan, baffle, spaces, filter, and grease tunnel and oil container.
- Always turn range hood ON when cooking at high heat or when cooking flaming foods.
- Use high settings on cooking range only when necessary.
- Never leave surface units (countertop/stove) unattended at high settings. Boil overs cause smoking and greasy spillover that may ignite. Heat oils slowly on low or medium settings.
- Clean ventilating fan frequently.

- Always use appropriate cookware and utensils size.
- Always use cookware appropriate for the size of the surface element.

To reduce the risk of injury to persons in the event of a stove top grease fire:

- SMOTHER FLAMES with a close-fitting lid, cookie sheet, or metal tray, then turn OFF the burner. BE CAREFUL TO PREVENT BURNS. NEVER PICK UP A FLAMING PAN—you may be burned. KEEP FLAMMABLE OR COMBUSTIBLE MATERIAL AWAY FROM FLAMES. If the flames DO NOT go out immediately, EVACUATE AND CALL THE FIRE DEPARTMENT or 911.
- DO NOT USE WATER, including wet dishcloths or towels — a violent steam explosion will result.
- Use an extinguisher ONLY if:
 - You know you have a Class A, B, C extinguisher, and you already know how to operate it.
 - The fire is small and contained in the area where it is started.
 - The fire department is being called.
 - You can fight the fire with your back to an exit.

To reduce the risk of injury to persons in the event of a gas leaks:

- Extinguish any open flame.
- DO NOT turn on the lights or any type of appliance.
- Open all doors and windows to disperse the gas. If you still smell gas, call the gas company and fire department, or 911 immediately.

Your safety and the safety of others are very important. We have provided many important safety messages in this manual and on your appliance. Always read and obey all safety messages. All safety messages will tell you what the potential hazard is, tell you how to reduce the chance of injury, and tell you what can happen if the instructions are not followed.

WARNING

This is the safety alert symbol. This symbol alerts you to potential hazards that can hurt you and others. All safety messages will follow the safety alert symbol and the word “WARNING”.

You hold all responsibility in the event of failure to observe the instructions given here for installation, maintenance and suitable use of the product. Further declines all responsibility for injury due to negligence and the warranty of the unit automatically expires due to improper maintenance.

It will not be held responsible for any damages to personal property or real estate or any bodily injuries whether caused directly or indirectly by the range hood.

4. VENTING HEIGHT REQUIREMENTS

- Vent system must terminate to the outside (roof or side wall).
- DO NOT terminate the vent system in an attic or other enclosed area.
- DO NOT use 4” (10.2 cm) laundry-type wall caps.
- Use metal/aluminum vent only. Rigid or flexible metal / aluminum vent duct is recommended.
- DO NOT use plastic vent.
- Always keep the duct clean to ensure proper airflow.
- Measure and estimate the following figures before installation:
 1. Distance between the countertop/stove to the bottom of the range hood. Recommend 24” to 30” for ideal performance, minimum 24” (inches) for safety concern.
 2. Height of hood and duct.

For the most efficient & quiet operation:

- A distance of 24” to 30” is recommended between stove top and the bottom of range hood.
- The vent duct isn’t included. It is recommended that the range hood be vented vertically through the roof through 6” (15.24 cm) or bigger round metal/aluminum vent work, such as 6 in. x 8 ft. semi-rigid aluminum flexible duct.
- The size of the vent should be uniform.
- Use no more than three 90° elbows.
- Make sure there is a minimum of 24” (61 cm) of straight vent between the elbows if more than one elbow is used.
- DO NOT install two elbows together.
- The length of vent system and number of elbows should be kept to a minimum to provide efficient performance.
- The vent system should have a damper. The damper can be installed in the duct near to the roof or wall cap. Not recommend to use damper on top of the range hood, because the damper has big noise.
- Use silver tape or duct tape to seal all joints in the vent system.
- Use caulking silicone to seal exterior wall or roof opening around the cap.

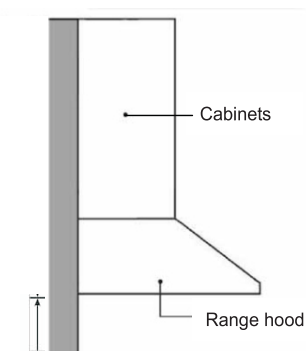

Min 24” Max 32”
Recommend 24” to 30”

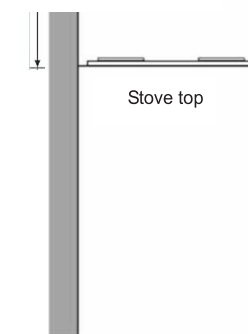

IMPORTANT:

- Please use *Duct Run Calculation* below to compute total available duct run when using elbows, transitions and caps.
- ALWAYS, when possible, reduce the number or transitions and turns. If long duct run is required, increase duct size from 6" to 7", 8" or 9". If a reducer is used, install a long reducer instead of a pancake reducer. Reducing duct size will restrict airflow and decrease airflow, thus reduce duct size as far away from opening as possible.
- If turns or transitions are required: Install as far away from opening and as far apart, between 2, as possible.
- Minimum mount height between stove top to hood bottom should be no less than 24-inch.
- Maximum mount height between stove top to hood bottom should be no higher than 32-inch.
- It is important to install the hood at the proper mounting height. Hoods mounted too low could result in heat damage and fire hazard; while hoods mounted too high will be hard to reach and will reduce its performance and efficiency.
- If available, also refer to stove top manufacturer's height clearance requirements and recommended hood mounting height above range.

Minimum Duct Size:

- Round - 6" minimum
- Rectangular - 3-1/4 x 10" minimum (requires a 6" to 3-1/4x10" adaptor, not supplied)

Calculating Vent System Length

To calculate the length of the system you need, deduct the equivalent feet for each vent piece used in the system from the recommended maximum duct run.

Duct Run Calculation	
Recommended maximum straight duct run	
6" or 3-1/4 x 10" duct	50 ft
Vent piece deduction	
Each 90° elbow used	9 ft
Each 45° elbow used	5 ft
Each 6" to 3/14 x 10" transition used	7 ft
Side wall cap with damper	0 ft
Roof cap	0 ft

Duct Run Calculation example:

*One roof cap, two 90° elbow, and one 45° elbow used:
 0ft + 9ft + 9ft + 5ft = 23ft used.
 Deduct 23ft from 50ft, 27ft maximum available for the duct run.*

5. VENTING METHODS

- This range hood is 6" top venting through the roof or wall.
- Vent work can terminate either through the roof or wall as shown below.
- A minimum of 6" round duct (purchase separately) or 3-1/4 x 10" rectangular duct (purchase separately) must be used to maintain maximum airflow efficiency.
- Always use rigid or semi-rigid type metal/aluminum ducts if available to maximize airflow.
- Decide the location of the venting pipe from the hood to the outside.
- A straight, short vent run will allow the hood to perform more efficiently. Try to avoid as many transitions, elbows, and long run as possible. This may reduce the performance of the hood.

IMPORTANT:

- NEVER exhaust air or terminate duct work into spaces between walls, crawl spaces, ceiling, attics or garages. All exhaust must be ducted to the outside.
- Fasten all connections with sheet metal screws and tape all joints with certified Silver Tape or Duct Tape.
- Use caulking to seal exterior wall or roof opening around the cap.

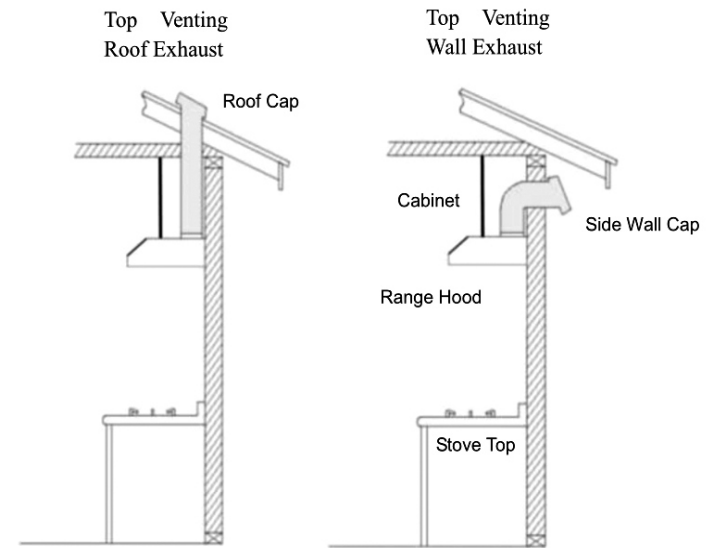

6. ELECTRICAL REQUIREMENTS & SPECIFICATIONS

IMPORTANT: Observe all governing codes and ordinances.

- **It is the customer's responsibility** to contact a qualified electrical installer.
- A 120 Volt, 60 Hz, AC only, fused electrical supply is required on a 15-amp circuit.
- DO NOT have a fuse in the neutral or ground circuit.
- The 3-prong outlet should be grounded. If the power cord plug is not used, the power cord's green wire should be connected to ground. Check with a qualified electrician if you are not sure that the range hood is properly grounded.
- DO NOT ground to a gas pipe.
- The range hood must be connected with copper wire/plug only.
- The range hood should be connected directly to the fused disconnect (or circuit breaker) box through flexible armored or non-metallic sheathed copper cable. ETL listed strain relief must be provided at each end of the power supply cable.

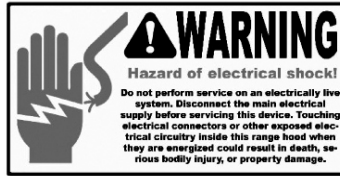

Specifications

Specifications:	
Body Design	Seamless Stainless Steel, Satin Finish
Power Rating	120V / 60Hz (USA & Canada standard)
General Input Power	156W (150W + 2x3W)
Motor Input Power	Max: 150W (75W + 75W), Min: 110W (55W + 55W)
Ampere	2 A
Levels Of Speed Control	4 Levels
Noise Level dB	Approximately 28 to 64 (Lowest to Highest Speed)
Number Of Motors	2 Motors
Motor Type	Single Chamber Ultra Quiet
Fan Type	Centrifugal Blower
Control Type	Press or Button+Knob or Touch or Gesture/Touch/Remote
Filtration Type	Aluminium filters
Illumination	3W 12V Maximum
Venting Size	Top 6" Round, Top or Back, 3 1/4 X 10 Rectangular Exhaust
Timer	3 Minutes Delay Off Timer or 1-15 Minutes Delay Off Timer (Only Touch or Gesture/Touch/Remote Control Type)

7. INSTALLATION PREPARATION

Test before installing:

- Please unpack the range hood and accessories carefully. Remove the baffle filters.
- Check for any dent or damage inside and outside. If found any loosing parts, please remove them.
- Place the range hood on a flat stable surface. Connect the range hood to a designated standard outlet (120-Volt, 60Hz, AC only). Press the power button and the speed buttons to turn on.
- **Check if any unusual metal touching noise, check the speed variation, and press the Light button to check the lights.** Verify all functions by referring to Section 9 RANGE HOOD OPERATIONS. Refer to Section 10 TROUBLESHOOTING if any malfunction was found.
- Place all supplied parts and required hardware on a flat stable surface and verify the existence of all supplied parts listed on Section 2 INCLUDED PARTS & ACCESSORIES.
- Note: The white plastic protective film was removed for sanding polish finishing.

NOTE: To avoid damage to your hood, prevent debris from entering the vent opening.

CAUTION: If moving the cooking range is necessary to install the hood, unplug the power on an electric range. **SHUT OFF THE GAS VALVE BEFORE MOVING A GAS RANGE.**

8. INSTALLATION INSTRUCTIONS

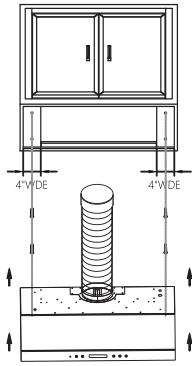
- 1) Installation planning
 - Measure the distance between stove top and the bottom of range hood. A distance of 24" to 30" is recommended. Minimum 24" is required for safety concern.
 - Decide the venting method and the location of the venting pipe from the hood to the outside.
 - Purchase any necessary accessories from a hardware store, such as duct, elbow, reducer, damper, duct tape, screws, etc.
 - Find and mark the stud locations using a stud finder to plan the mounting locations firmly.
- 2) Measure the top vent and the power cord positions, cut the openings (slightly larger for easy accessible) for hood exhaust and power cord under the cabinet.
- 3) For installing under the cabinet with recessed bottom, attach 4-inch wide wood filler strips (not provided) on each side.
 
- 4) Puncture the knockout screw holes on the top for screw mounting under the cabinet.
- 5) Mount this range hood under the cabinet, 2 people are required for this installation.
 - Draw power cord through cabinet access opening and center the hood beneath the cabinet.
 - From inside of the hood, place screws into the exact center of each knockout hole and secure to cabinet bottom. Finish tightening all screws until secure.

CAUTION: Make sure the range hood is secure before releasing!

- For safety purpose, mount the screws through the pre-drilled mounting holes or/and drill new holes from inside the back of the hood to the studs or lumbers. For a more secure installation, use as many mounting holes as needed to secure from the inside of hood.
- 6) Use 6" round metal duct (or semi-rigid aluminum duct, follow building codes in your area) to connect the exhaust on the hood to the duct-work above. Use foil tape or duct tape to make all joints secure and air tight.
 - 7) Connect the power cord to a designated grounded standard 110V outlet.
 - Or cut off the plug and connect three wires (black, white and green) to house wires and cap with wire connectors. Connect according to colors (i.e. black to black, white to white, and green to green). Store excess wires in the wiring box.
 - 8) Install aluminium filters and stainless spacer if any.

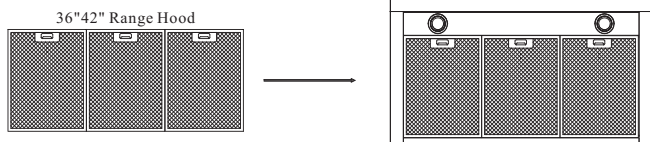
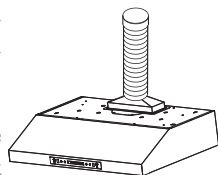

- 9) Turn power ON in control panel. Check all lights and fan operations.

9. RANGE HOOD OPERATIONS

Control Panel Layout and Buttons Configurations:

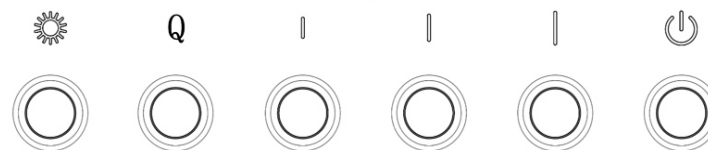

Light

Press the Light button once and the lamps will turn on. Press the Light button again and the lamps will turn off. Press and Hold the Light button to adjust the Brightness of the lamps. Release the Light button until the desired brightness is reached. The Light button operates independently from the Power button. It works even when the range hood is not turned on. Always turn off the Lights before powering off the range hood.

Power

Press the Power button once and the hood will be activated. Press the Power button again will activate the Delayed Auto Shutoff function. Press the Power button the 3rd time will shutoff the range hood immediately.

Delayed Auto Shutoff Function

When the hood is operating in any speed, press the Power button once will activate the Delayed Auto Shutoff function. The range hood will shutoff automatically in 3 minutes.

While the Delayed Auto Shutoff function is activated, press the Power button again and the hood will shutoff immediately.

Speed Control

Note

The Power button must be pressed once before any speed mode can be selected.

Quiet Mode

Press the Q button will activate the quiet mode.

The range hood in the quiet mode will run at the lowest speed and generate less noise. Perfect for light cookings.

Low Speed Mode

Press the Low Speed button will activate the hood at Low speed.

Medium Speed Mode

Press the Medium Speed button will activate the hood at Medium speed.

High Speed Mode

Press the High Speed button will activate the hood at High speed.

Selecting Speed Modes

Press the Power button once to activate the hood. The LED on the Power button will be illuminated.

Press one of the four speed button to activate the desire speed. The LED on the speed button will be illuminated accordingly.

To switch to a different speed mode, press a different speed button. The LED on the speed button will be illuminated accordingly.

Range Hood Operations

Control Panel Layout and Buttons Configurations:

1. Sleep

After turning on the power, the standby interface displays sleep and the backlight is turned off.



2. Gear Position

In the sleep or light interface, press the knob to enter the gear position.



In the gear interface, rotate the knob to cycle clockwise through F0-F1-F2-F3-F4-F0, and counterclockwise through F0-F4-F3-F2-F1-F0.

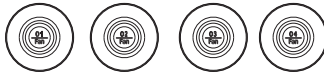

3. Lighting

On the gear interface, press the knob to enter light.



On the light interface, rotate the knob to switch the light on and off.

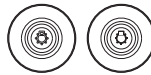

4. Delay

When the wind speed is on, press and hold the knob to enter the delay interface. Countdown for 180 seconds. After the countdown ends, all functions will be turned off and entered the sleep interface.



Long press the knob on the "Delay" to enter sleep.

RANGE HOOD OPERATIONS

Control Panel Layout and Buttons Configurations:

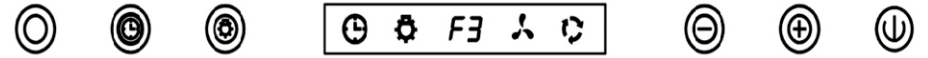

Buttons from right to left

Power Control (On/Off):

- Please press the *Power Control* button before pressing *Increase +* button or *Decrease -* button to turn on the blower.
- Please press the *Power Control* button again to turn off the blower.

Blower Speed Selection:

- While the power is on, press *Increase +* or *Decrease -* button to start the blower. Press *Increase +* button to increase blower speed (F1 to F4) as indicated in LCD panel. The *Increase +* button cycles blower settings from off (00), quiet speed (F1), low speed (F2), medium speed (F3) to high speed (F4).
- While the range hood is on and the blower is running, press *Decrease -* button to decrease blower speed (F4 to F1) as indicated in LCD panel.

Light Control:

- Press *Light Control* button once to turn on the lights, and once again to turn off the lights.
- The *Light Control* button operates independently from the *Power Control* (On/Off) button. Pressing the *Power Control* button will not turn LED lights ON or OFF. While *Light Control* button will be affected by the power-off delay function. Activating the delay function will turn LED lights OFF immediately.

Power-Off Delay Function:

- While the range hood is on and the blower is running in normal mode, press *Power-Off Delay* button to activate delay off timer and "Power-Off Delay" icon will appear in LCD panel.
- Adjust to desired period of delay off timer by pressing *Increase +* or *Decrease -* button (minimum 1 minute to maximum 15 minutes).
- Timer begins to countdown immediately, when it reaches 0, both the blower and light will shut off immediately.

Remote Control:

- Remote control sensor receives infrared (IR) signal from the remote control. The maximum distance for IR data transmission is 3 meter (10 ft.) and requires direct line of sight. The transmission distance may vary depending on temperature and remote control battery condition.

Note: Light settings are independent from other settings (including power-off delay) and lights have to be manually turned on or off.

Control Panel Layout and Buttons Configurations:

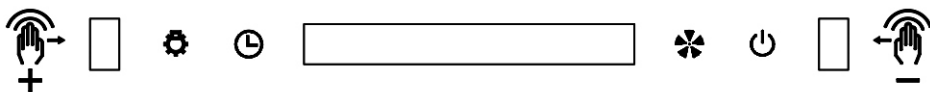

1. From left to right side: Lighting Key (K1), Timer Key (K2), LED Display, Speed Key (K3), Power Key (K4)
2. When the power supply connected, all indicate lighting is On and then Off in 1 second. To press K4 to open the hood.
3. When the hood is On, to press K3 to open Fan Speed 1st, to press again to open Fan Speed 2nd, as so forth, to open Fan Speed 3rd and 4th by K3. The Fan Speed is changed as 1-2-3-4-0-1-2-3-4.
4. If there was any fan speed working, to press K2 to open Timer Mode, the default is 3 minutes and do count-down step. Or to press K2 or K3 to set the timer as wanted, the maximum timer is 15 minutes.
5. To press K1 to open or close the lamp. The luminance of lighting can be adjusted from 0% to 100% as wanted by touching K1.
6. **Gesture Control:** to move your hand from left side to right side to open 1st Fan Speed. And again to open 2nd Fan Speed, and 3rd, and 4th.
On the contrary, to move your hand from right side to left to reduce the speed level.

Please Note:

1. Press and hold K2 for 3 seconds to turn on/off the gesture sensing function
(Note: only valid in non-working state)
2. Please wave your hand quickly through the right&left sensing window, and the distance between your hand and the panel should be < 10cm.

Optional

This hood switch control can be operated by remote controller if wanted.

Operation Cautions:

- Read and understand all instructions and warnings in this manual before operating the appliance.
- Always leave safety grills and filters in place. Without these components, operating blowers could catch on to hair, fingers and loose clothing.
- NEVER dispose cigarette ashes, ignitable substances, or any foreign objects into blowers.
- NEVER leave cooking unattended. When frying, oil in the pan can easily overheat and catch fire. The risk of self-combustion is higher when the oil has been used several times.
- NEVER cook on “open” flames under the range hood. Check deep-fryers during use: Superheated oil may be flammable.

10. TROUBLESHOOTING



If the range hood or LED light does not operate after installation	<ul style="list-style-type: none"> • Check if the range hood has been plugged in, make sure that all power has been turned back ON, fused not blown and all electrical wiring are properly connected. • Swap out light assembly to working ones to determine whether it is caused by defective bulbs. See <i>Replacing the Light Bulbs</i> on Page 14.
The range hood vibrates when the blower is on	<ul style="list-style-type: none"> • The range hood might not have been secured properly on to the cabinet or wall.
The blower or fan seems weak	<ul style="list-style-type: none"> • Check that the duct sized used is at least 6” or 3-1/4 x 10”. Range hood WILL NOT function efficiently with insufficient duct size. For example: 7” duct over 6” top vent and loosely secured. • Check if duct is clogged or if damper unit (half-circular flapper) is not installed correctly or opening properly. A tight mesh on a side wall cap unit might also cause restriction to the air flow.
The lights work but the blower is not spinning at all, is stuck or is rattling	<ul style="list-style-type: none"> • The blower might be jammed or scraping the bottom due to shipping damage. • Disconnect the power cord, remove the fan grill and the fan blade, might see the fan blade or/and motor is not in the proper position (offset from the center). Try to fix/adjust it or please contact us immediately.
The hood is not venting out properly	<ul style="list-style-type: none"> • Make sure the distance between the stove top and the bottom of the hood is within recommended 24” and 30” in distance. <i>*Due to different ceiling height configurations, recommended height may not be applicable.</i> • Reduce the number of elbows and length of duct work. Check if all joints are properly connected, sealed, and taped. • Make sure the power is on high speed for heavy cooking.

11. MAINTENANCE AND CLEANING

Cleaning:

- The saturation of greasy residue in the blower and filters may cause increased inflammability. Keep unit clean and free of grease and residue build-up at all times to prevent possible fires.
- For optimal operation, clean range hood and all baffle/spacer/filter/grease tunnel/oil container regularly. Regular care will help preserve the appearance of the range hood.
- Filters must be cleaned periodically and free from accumulation of cooking residue. Old and worn filters must be replaced immediately.
- DO NOT operate blowers when filters are removed. Never disassemble parts to clean without proper instructions. Disassembly is recommended to be performed by qualified personnel only. Read and understand all instructions and warnings in this manual before proceeding.

SAFETY WARNING: Never put your hand into area housing the fan while the fan is operating!

Cleaning Exterior Stainless Steel Surfaces:

- Clean periodically with hot soapy water and clean cotton cloth. DO NOT use corrosive or abrasive detergent, or steel wool/scoring pads, which will scratch and damage the stainless steel surface. For heavier soil use liquid degrease cleaner.
- If hood looks splotchy, use a stainless steel cleaner to clean the surface of the hood. Avoid getting cleaning solution onto or into the control panel. Follow directions of the stainless steel cleaner.
- **CAUTION: DO NOT leave on too long as this may cause damage to hood finish.** Use soft towel to wipe off the cleaning solution, gently rub off any stubborn spots. Use dry soft towel to dry the hood.
- After cleaning, you may use nonabrasive stainless steel polish, to polish and buff out the stainless luster and grain. Always scrub lightly, with clean cotton cloth, and with the grain.
- DO NOT allow deposits to accumulate or remain on the hood.
- DO NOT use ordinary steel wool or steel brushes. Small bits of steel may adhere to the surface and cause rusting.
- DO NOT allow salt solutions, disinfectants, bleaches, or cleaning compounds to remain in contact with stainless steel for extended periods. Many of these compounds contain chemicals, which may be harmful. Rinse with water after exposure and wipe dry with a clean cloth.

Cleaning Aluminium Filters:

- Remove all baffles, spacers, filters, grease tunnel, and oil containers and discard oil and residue.
- **IMPORTANT:** Drain oil from baffles, spacers, filters, oil tunnels, oil containers before oil and residue overflow!
- Wash with warm soapy water. NOTE: Aluminium filters, spacers and oil tunnel are top rack dishwasher safe.
- Dry thoroughly before replacing and follow directions for installation in reverse.
- Filters should be cleaned after every 30 hours of use.

Replacing Filters:

- Should filters wear out due to age and prolonged use, replace the aluminium filters immediately.

Replacing the Light Bulbs:

- This range hood uses LED bulbs: 3W 12V.
- Make sure the range hood is unplugged or turn OFF breaker.
 1. Gently pull the defective bulb assembly straight out from the edge, and then disconnect the wires.
 2. Connect the new LED bulb's wires and snap the new LED assembly into the housing hole.
 3. Turn ON breaker/power and to test the range hood for operation.

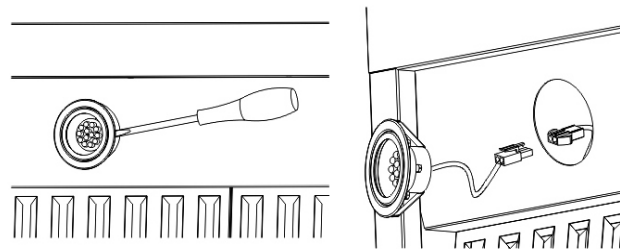

12. WARRANTY

Please provide an original dated proof of purchase (sales receipt / invoice) in order to obtain warranty.

One Year Parts Warranty:

- For one year from the date of original purchase, we will provide free of charge, non-consumable replacement parts or components that failed due to manufacturing defects. Subject to the conditions and limitations set forth below, we will, at its option, either repair or replace any part of its products that prove defective by reason of improper workmanship or materials.
- Repaired parts or replacement products will be provided by us on an exchange basis, and will be either new or refurbished to be functionally equivalent to new.
- The consumer is responsible for all shipping costs.
- Consumable parts not covered by this warranty include but not limited to: light bulbs, stainless steel baffle filters.

Who is Covered?

- This warranty is extended to the original purchaser for products purchased for ordinary home use in the continental USA.

This Warranty Will Be Voided When:

- Product damaged through negligence, improper installation, accident, abuse, misuse, natural disaster, insufficient or excessive electrical supply, abnormal mechanical or environmental conditions, or any unauthorized disassembly, repair, modification, or failure to follow installation instructions.
- When product is used commercially or other than its intended purpose.
- Damaged because of improper connection with equipment of other manufacturers. Repaired or modified by anyone other than our authorized agents.
- This limited warranty also does not apply to any product on which the original identification information has been altered, obliterated or removed, has not been handled or packaged correctly, has been sold as second-hand.

What is Not Covered?

- Consumable parts such as light bulbs, stainless steel baffle filters. The natural wear of finish, and wear due to improper maintenance, use of corrosive and abrasive cleaning products, pads, and oven cleaner products.
- Chips, dents or cracks due to abuse, misuse, freight damage, or improper installation.
- Damage of product caused by accident, fire, floods or act of God. It is not liable for, and does not cover under warranty, any loss of properties or any costs associated with removing, servicing, installing, or determining the source of problems with our products.

This warranty is valid in the United States. It is non-transferable and applies only to the original purchaser and does not extend to subsequent owners of this product. Any applicable implied warranties, including the warranty of merchantability, are limited in duration to a period of express warranty as provided herein beginning with the date of original purchase at retail and, no warranties, whether express or implied, shall apply to this product thereafter.

To obtain warranty service, you may contact us, its dealer or distributor from which you purchased the product. Please confirm the terms of your dealer's or distributor's policies prior to contacting. Typically, you must include product identification information, including model number and lot number with a detailed description of the problem you are experiencing. You must also include proof of the date of original retail purchase as evidence that the product is within the applicable warranty period.

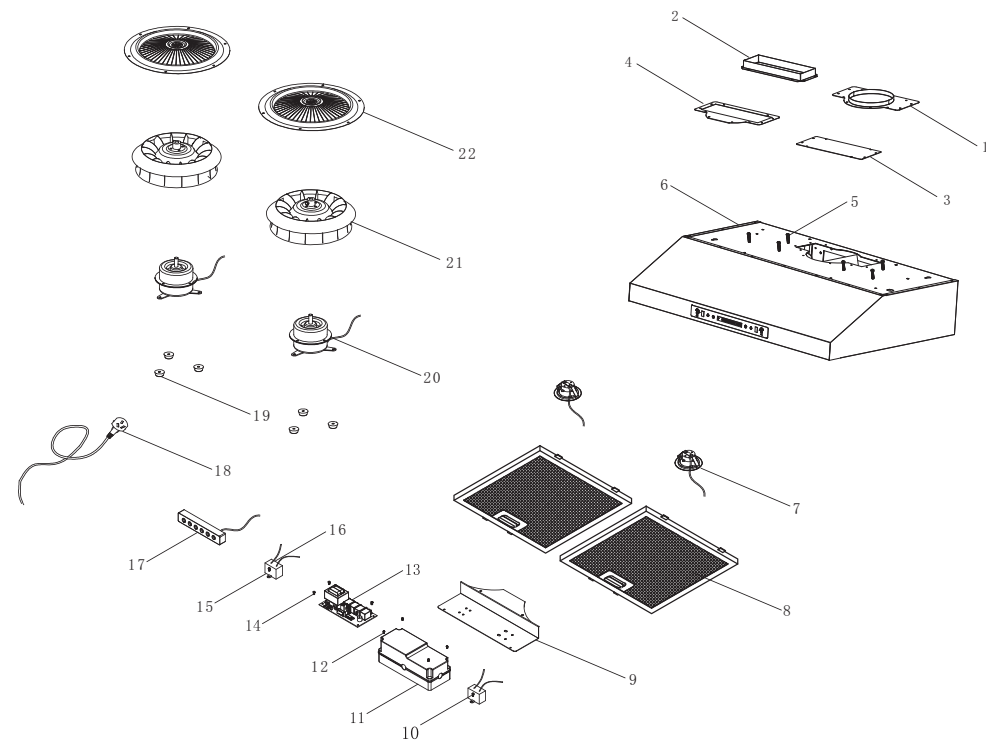
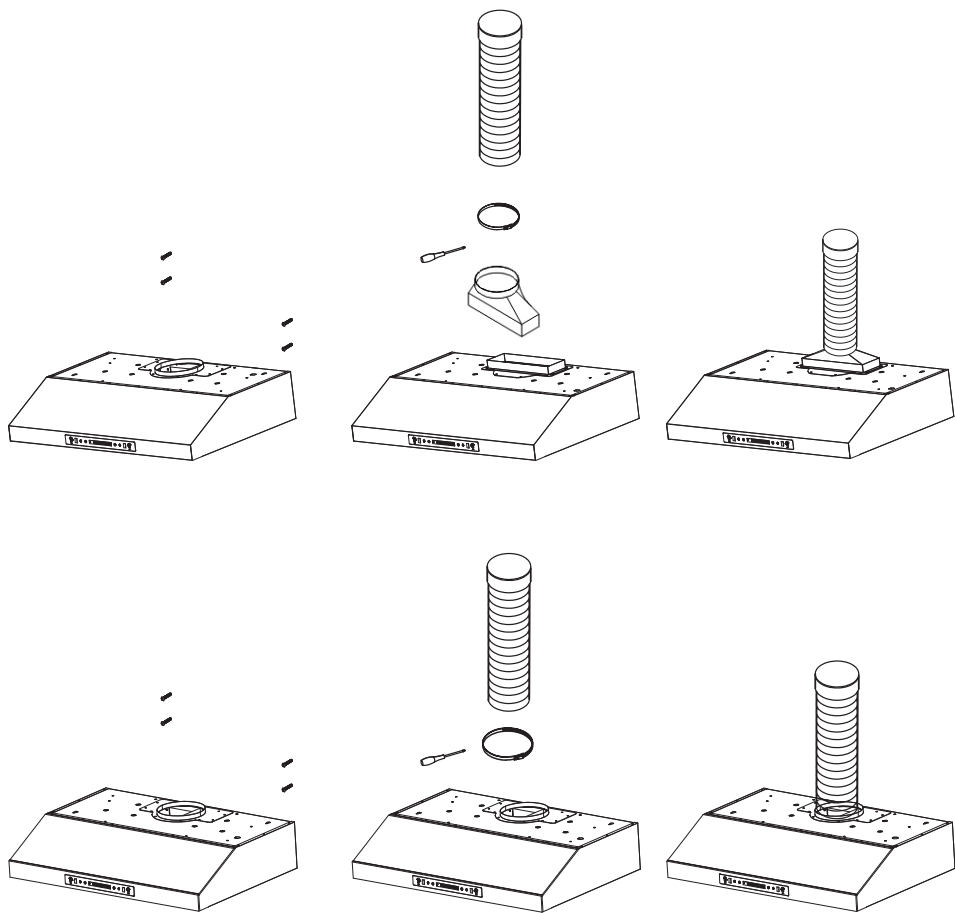

MEASUREMENTS & DIAGRAMS

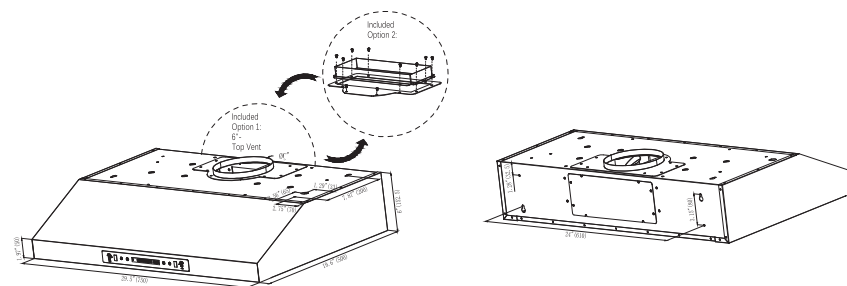

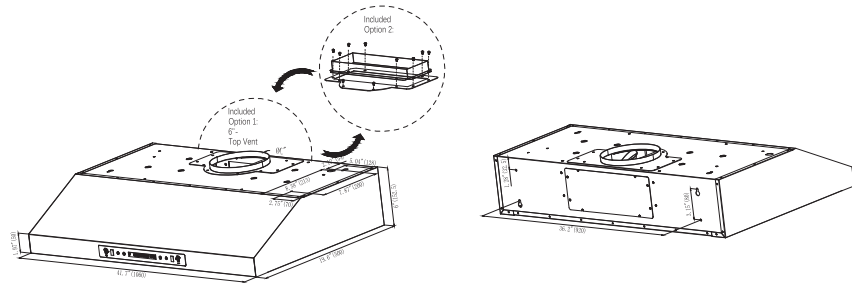
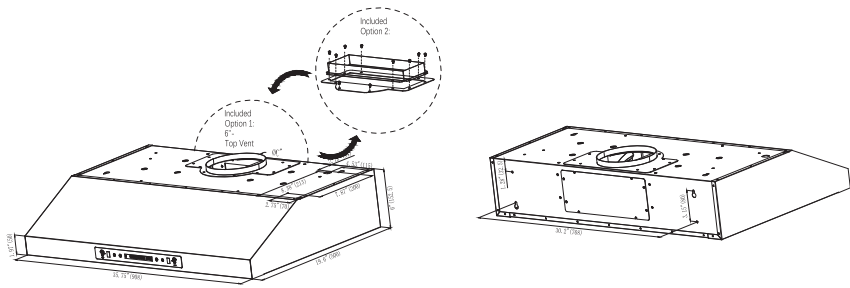

Included
Option 3:

