

# Assembly Instruction









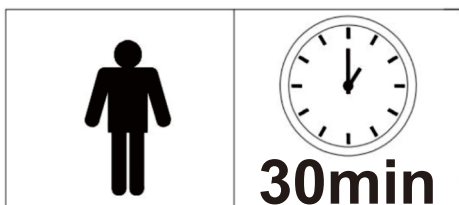
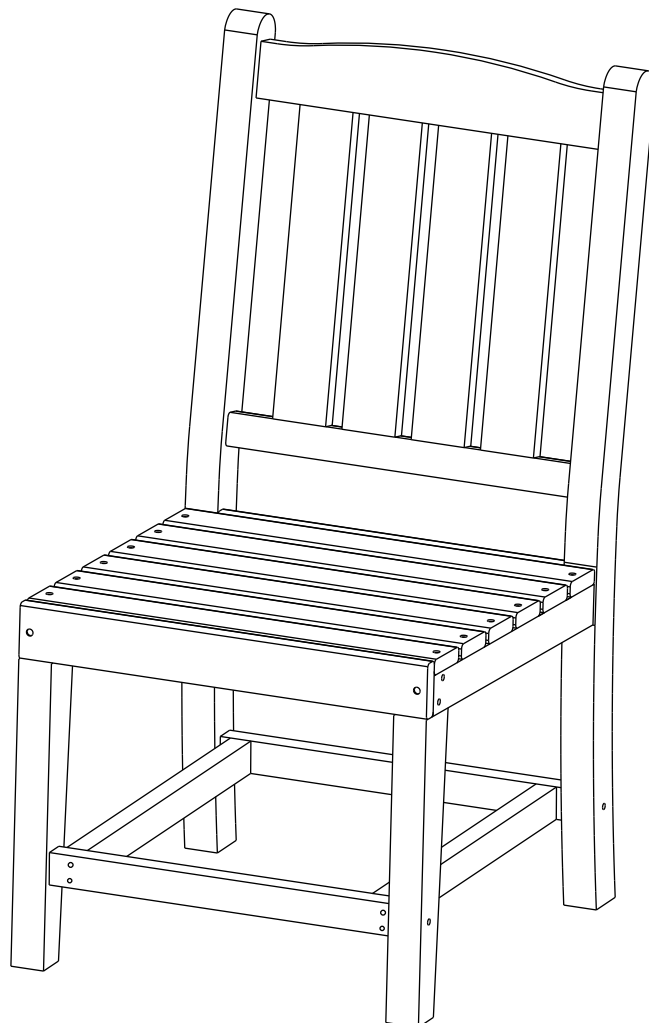

Dear Customer

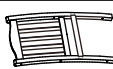
Thank you for choosing our product. This HDPE Dining Chair is designed and packed in compact way. You are required to assemble according to our instruction. All component or accessories are included within the package. Simple a few steps & around 30 Minutes needed by single person.

Wherever you purchased from, if you are happy with our products, your rating, review or feedback would be highly appreciated. In case the product came with any damages or defectives, please feel free to contact us for free replacement or money refunding.

Thanks again



<b>A</b>		<b>1pc</b>	<b>1</b>	 <b>M6X50</b>	<b>4pcs</b>
<b>B</b>		<b>1pc</b>	<b>2</b>	 <b>M6.3X80</b>	<b>4pcs</b>
<b>C</b>		<b>1pc</b>	<b>3</b>	 <b>M6.3X60</b>	<b>4pcs</b>
<b>D</b>		<b>1pc</b>	<b>4</b>	 <b>M6</b>	<b>4pcs</b>
<b>E</b>		<b>1pc</b>	<b>5</b>		<b>1pc</b>
			<b>6</b>		<b>1pc</b>

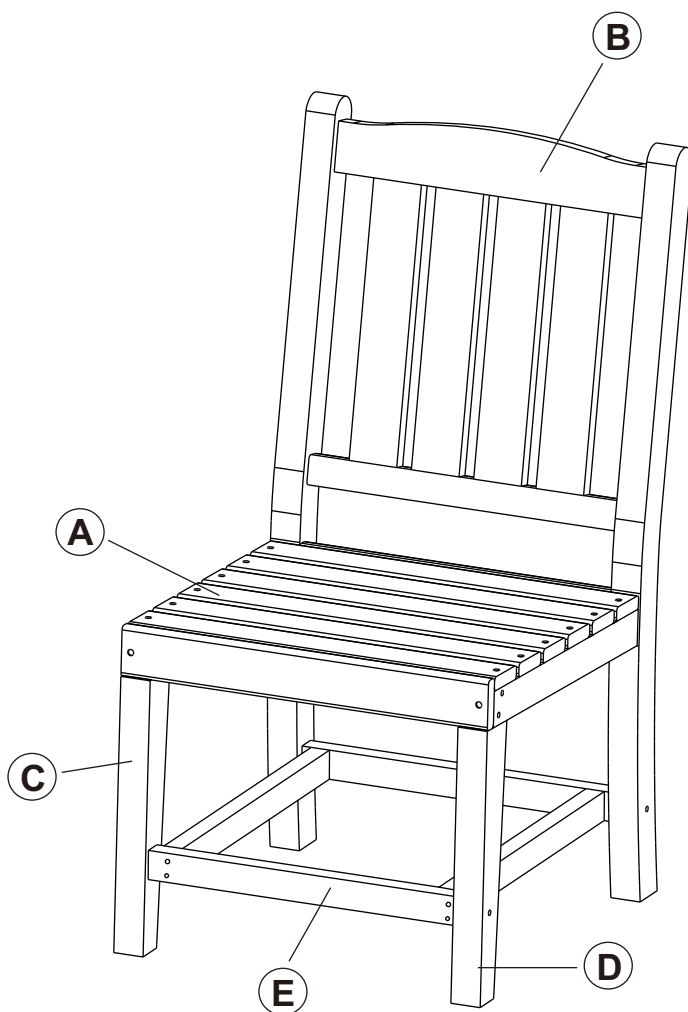

# STEP:1

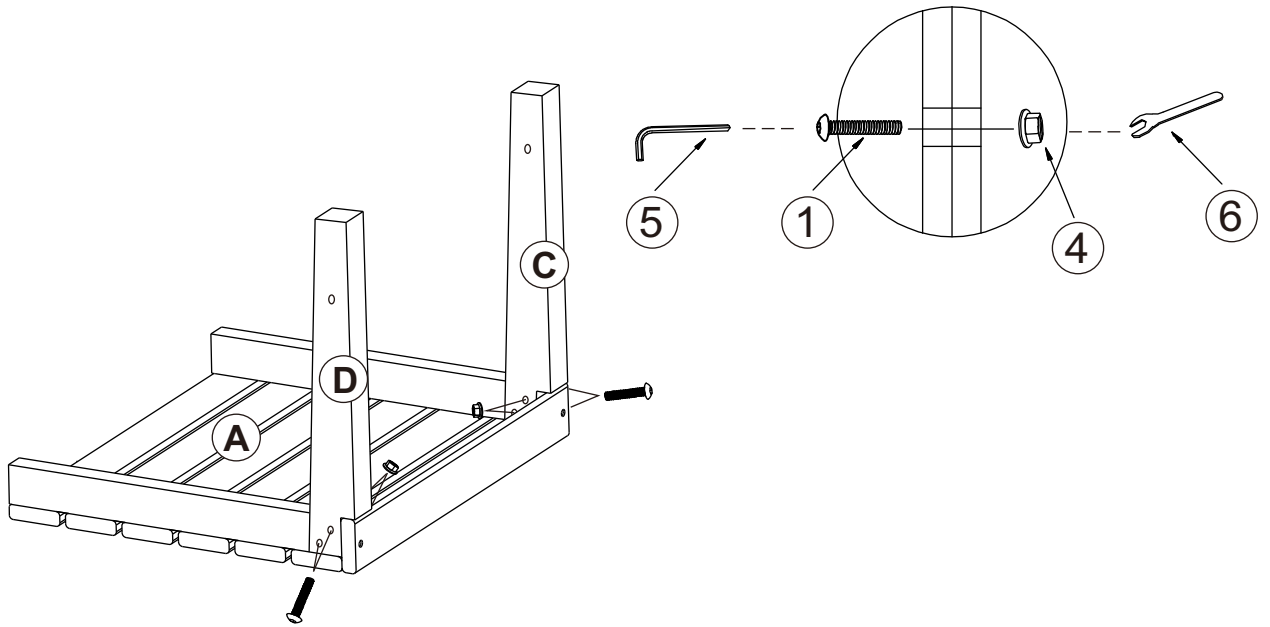

# STEP:2

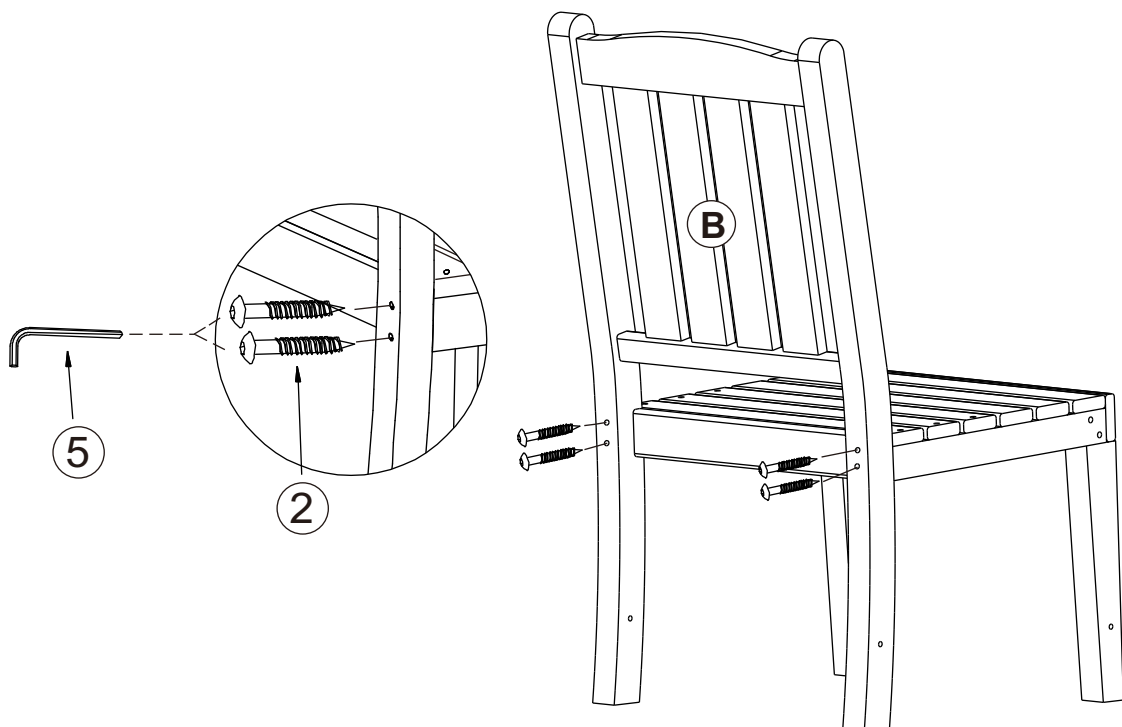

# STEP:3

