

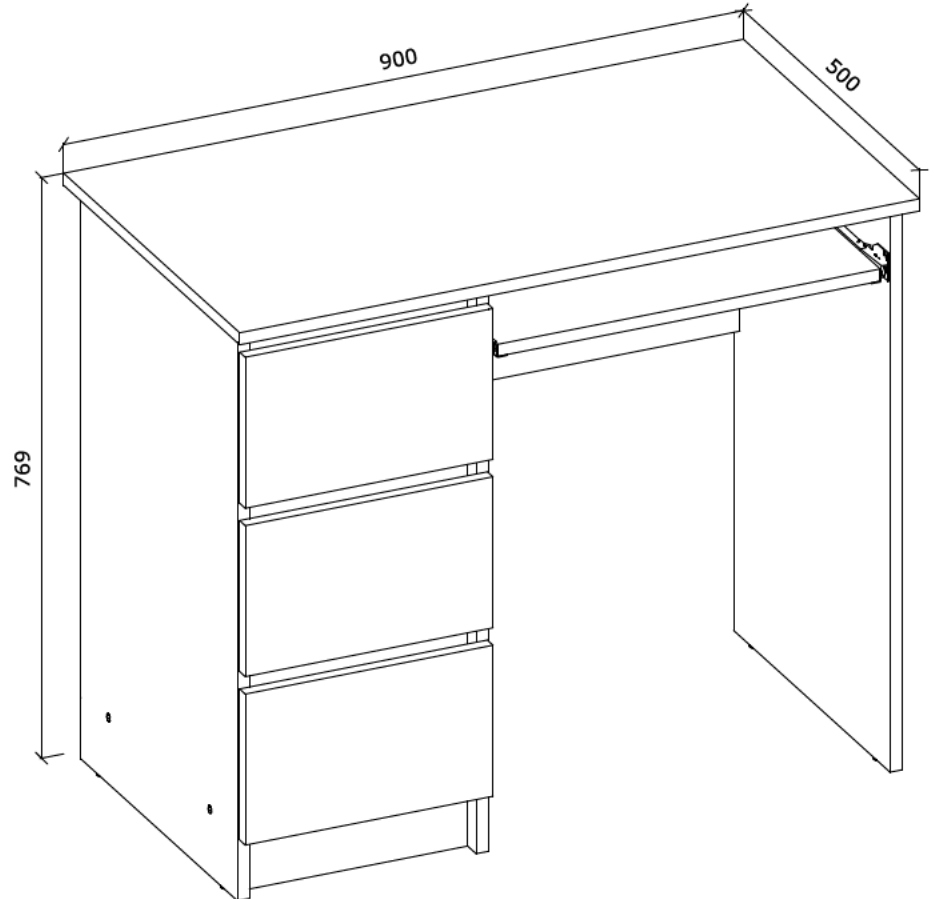

Schreibtisch Computertisch Shefa Line CINA Computer desk Shefa Line Cina

(DE) Montageanleitung:
(EN) Assembly instructions:

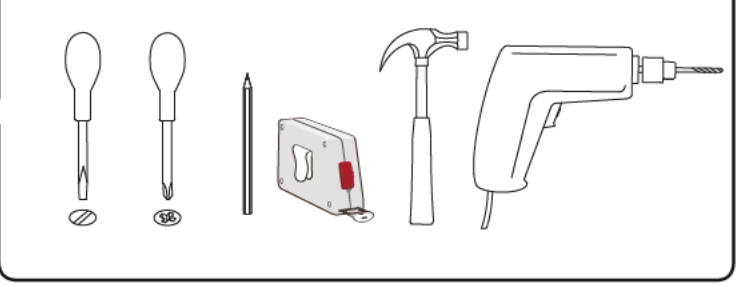
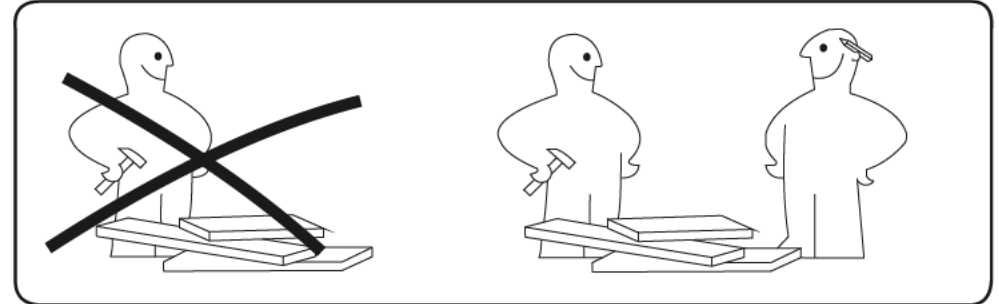
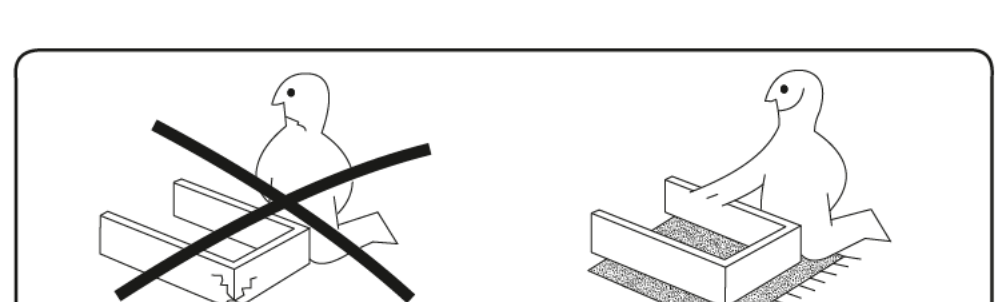
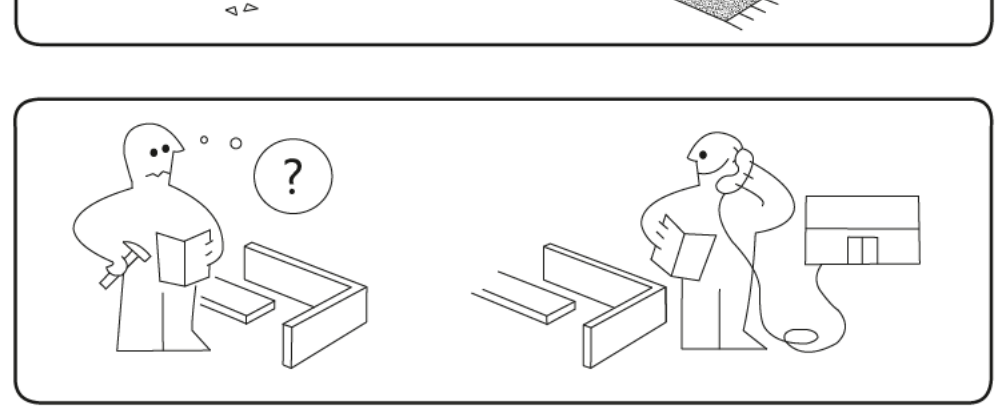

 <p>Informazioni importanti. Leggere attentamente. Consultare queste informazioni per ulteriori avvertenze.</p>	<p>IT AVVERTENZA</p> <p>Se il mobile è installato su cassero inedito da un tecnico che è installato, per prevenire il rischio che il mobile si ribalti, quest'ultimo deve essere permanentemente ancorato alla parete.</p>	<p>FR AVERTISSEMENT</p> <p>Risque de blessure grave en cas de chute de meubles. Pour éviter que le mobile ne bascule, il faut le fixer à une paroi permanente.</p>	<p>PL UWAGA</p> <p>Przeważenie ciężkości może doprowadzić do przewrócenia się mebla. Aby zapobiec przewróceniu się mebla, należy na stałe przyczepić go do ściany.</p>	<p>CZ VAROVÁNÍ</p> <p>Předtím než začnete sestavovat, vždy si přečtěte pozorně všechny pokyny. Především je třeba meble připevnit ke stěně.</p>	<p>SK POZOROVANIE</p> <p>Pri zbiraní a zbieraní nábytku vždy si pozorne prečítajte všetky pokyny. Aby sa predišlo prevráteniu nábytku, upevniť ho na stenu.</p>
<p>NL WAARSCHUWING</p> <p>Wanneer meubels omvallen, kan er ernstig of levensbedreigend behalvemogelijkheid ontstaan. Om te voorkomen dat dit risico ontstaat, dient het meubel aan de wand te worden bevestigd.</p>	<p>SRB UPOZORENJE</p> <p>Koga meštali odložite poručite ujed pripremiti namenska. Da ovaj meštali ne bi pao, mora biti pričvršćen na zid.</p>	<p>HU FIGYELM</p> <p>Abszor súlyos sérülés, vagy akár végzetes károsodás okozhat, ha az asztal nem lesz megfelelően rögzítve a falhoz.</p>	<p>RO ATENȚIE</p> <p>Pentru prevenirea rănii grave deosebi importantă de avertiza de mobilier. Pentru prevenirea rănii, mobilul trebuie fixat permanent în perete.</p>	<p>TR UYARI</p> <p>Mobilyanın ağırlığını düşününce dikkatli olunuz. Özellikle ağır mobilyaları duvara sabitlemek için mutlaka duvarla sabitleyin.</p>	<p>ES ADVERTENCIA</p> <p>Pueden producirse lesiones graves o fatales si vuelven a caer muebles. Para evitar que vuelvan a caer, los muebles deben fijarse permanentemente a la pared.</p>
<p>HR UPOZORENJE</p> <p>Ako se namještaji prevrnu može doći do ozbiljnih i smrtalnih ozljeda. Kako bi izbjegli prevrtanje, namještaj mora biti pričvršćen na zid.</p>	<p>BG ВНИМАНИЕ</p> <p>Противтежестите на този мебели могат да доведат до сериозни или смъртни наранявания, ако мебелта не е закрепена за стени.</p>	<p>SE VARNING</p> <p>Allvariga eller livfarliga skador kan ske om möbelskåp över för mycket belastas. För att undvika detta bör möbelskåpet fästas permanent vid väggen.</p>	<p>PT IMPORTANTE</p> <p>As quedadas de mobilva podem originar consequências sérias. Estas quedadas devem ser evitadas através da fixação permanente do mobiliário à parede.</p>	<p>UA УВАГА</p> <p>Підняти навантаження можуть стати причиною серйозних травм чи смертельних поранень. Щоб уникнути цього, мебелі потрібно постійно кріпити до стіни.</p>	<p>DK ADVARSEL</p> <p>Der kan opstå alvorlig eller livsfarlig skade, hvis møbler falder. For at undgå dette, skal møblerne permanentt fastgøres til væggen.</p>
<p>GR ΠΡΟΒΛΕΠΟΜΕΝΗ</p> <p>Εάν δεν εγκαταστήσετε σωστά τον επίπλο, μπορεί να συμβεί τραυματισμός ή και θάνατος. Για να αποφύγετε αυτό, πρέπει να ασφαλίσετε τον επίπλο στην τοίχο.</p>	<p>BG ВНИМАНИЕ</p> <p>Когато не се вземат мерките за предотвратяване на тежките наранявания, които могат да доведат до смъртен исход, мебелта трябва да бъде закрепена за стената.</p>	<p>NO ADVARSEL</p> <p>Allvarlige ulykker kan skje som følge av møbler som veies for å trykkes ut eller som belastes med for mye. For å unngå dette bør møbelskåpet festes permanent til veggen.</p>	<p>FI VAROITUS</p> <p>Huonokalusteiden kääntäminen voi aiheuttaa vakavia loukkaantumia tai jopa kuolemaan. Vakavien loukkaantumien välttämiseksi kalusteiden tulee kiinnittyä seinään.</p>	<p>FI VAROITUS</p> <p>Pöytä ja seelien kääntäminen voi aiheuttaa vakavia loukkaantumia tai jopa kuolemaan. Vakavien loukkaantumien välttämiseksi pöytä ja seelien tulee kiinnittyä seinään.</p>	<p>DK ADVARSEL</p> <p>Der kan opstå alvorlig eller livsfarlig skade, hvis møbler falder. For at undgå dette, skal møblerne permanentt fastgøres til væggen.</p>

			
--	---	--	---

7 **300mm.**
T2 x1 K1 x4

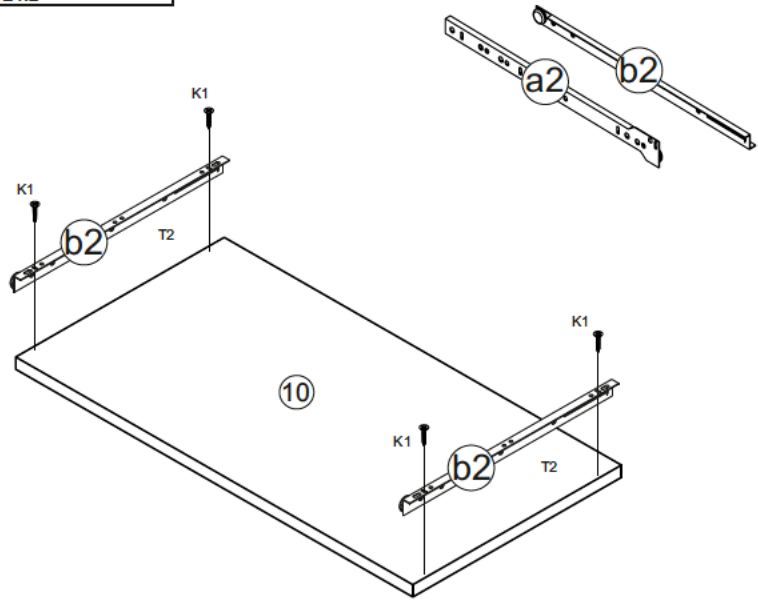

8

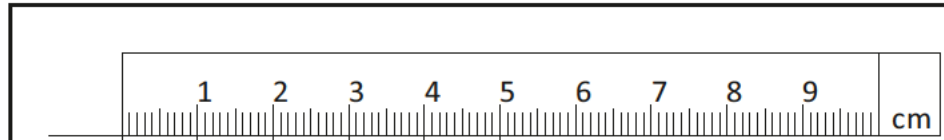
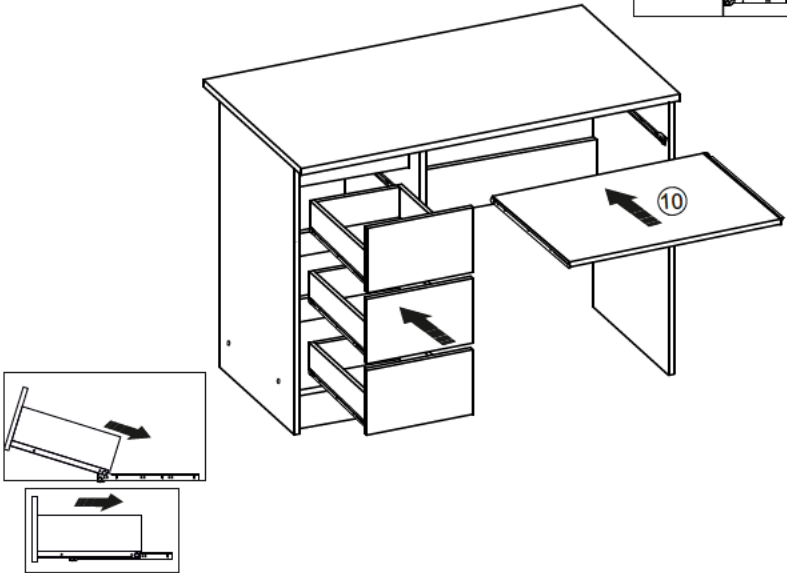
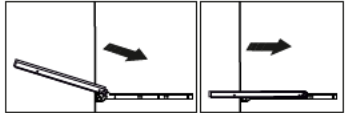



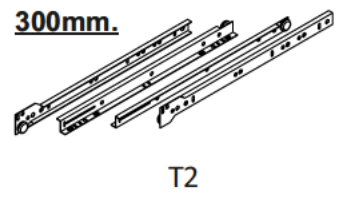
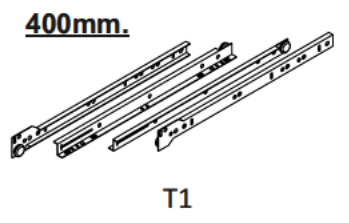











- K1
- K2
- I
- MB
- G
- K
- Kz
- Mz









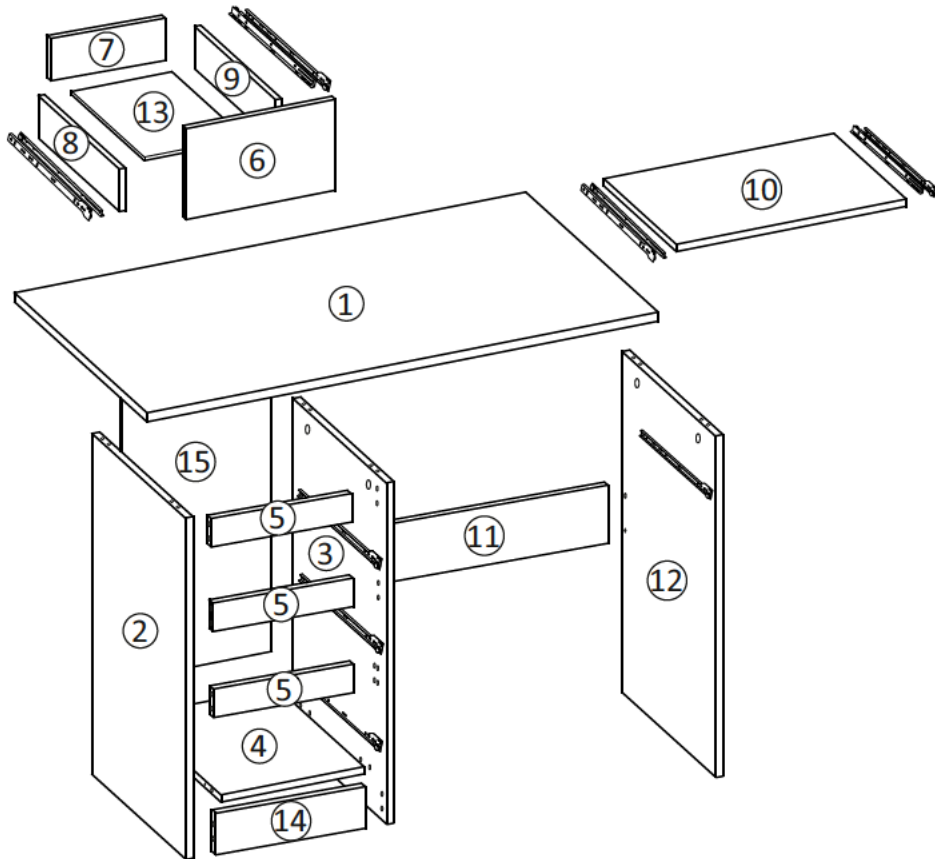

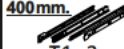

①	x 1	900	500	16 mm
②	x 1	750	444	16 mm
③	x 1	750	444	16 mm
④	x 1	300	444	16 mm
⑤	x 3	300	60	16 mm
⑥	x 3	200	328	16 mm
⑦	x 3	100	243	16 mm
⑧	x 3	100	400	16 mm

⑨	x 3	100	400	16 mm
⑩	x 1	506	285	16 mm
⑪	x 1	532	150	16 mm
⑫	x 1	750	444	16 mm
⑬	x 3	405	273	3 mm
⑭	x 1	300	80	16 mm
⑮	x 1	670	330	3 mm

I x 50		K2 x 16		K1 x 24		N x 6		G x 60	
K x 14		Kz x 14		MB 12		M x 12		Mz x 12	
KK x 1		T1 400mm. x 3		T2 300mm. x 1		O x 6			



6										
	T1 x3	K x6	Kz x6	M x6	Mz x6	MB x6	G x33	I x24	K1 x12	O x6

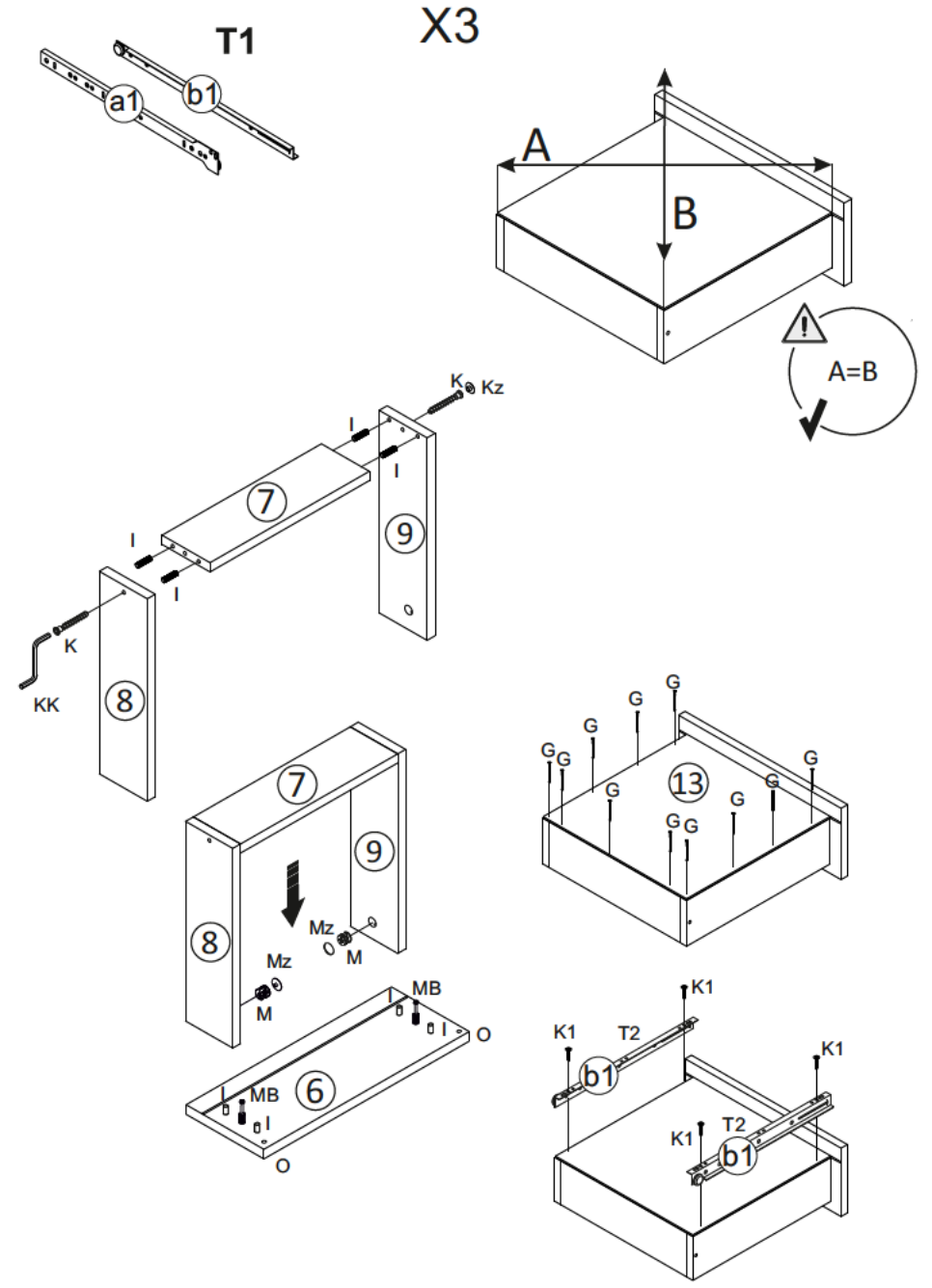

4

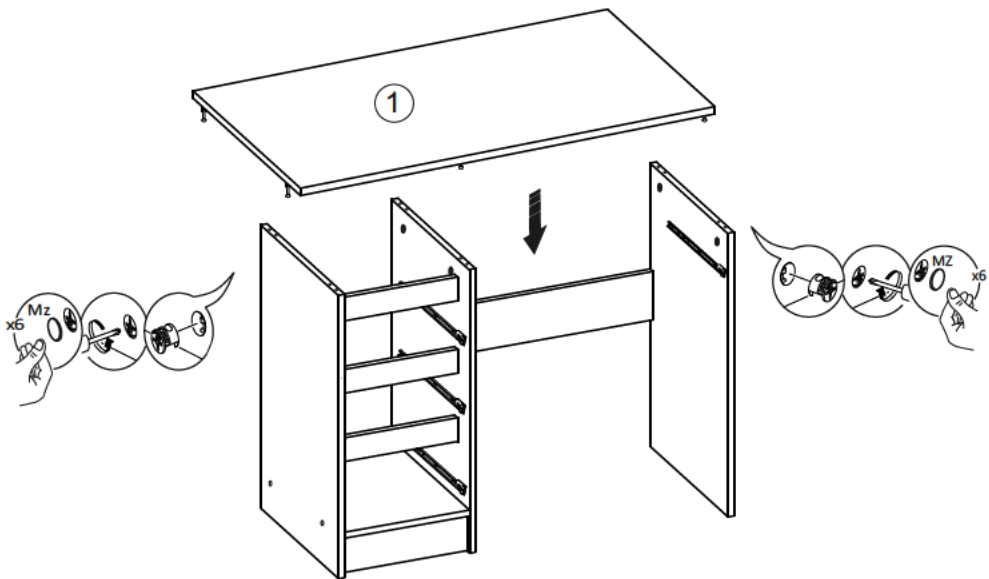

5

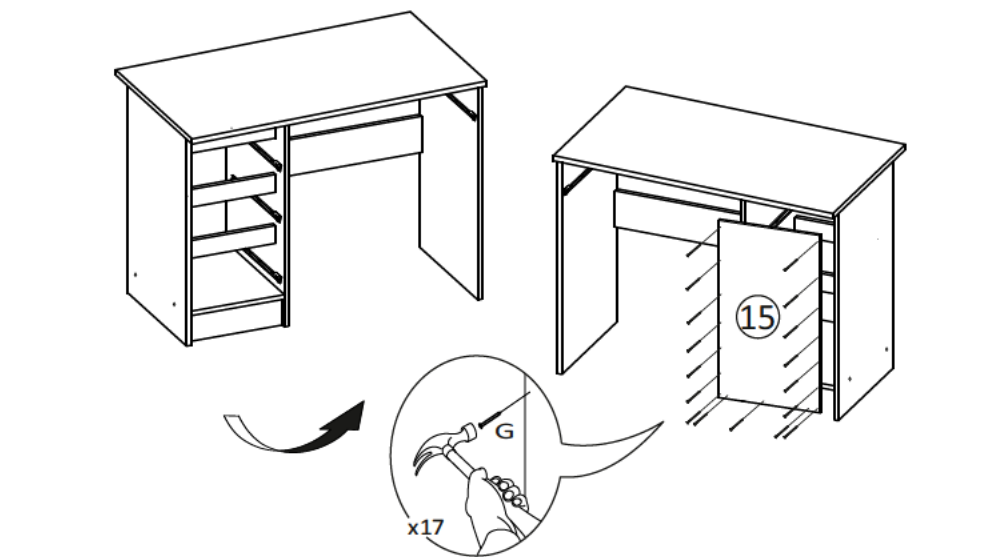

1

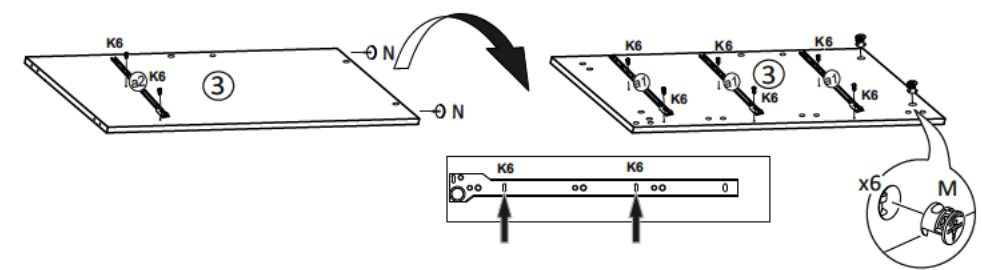
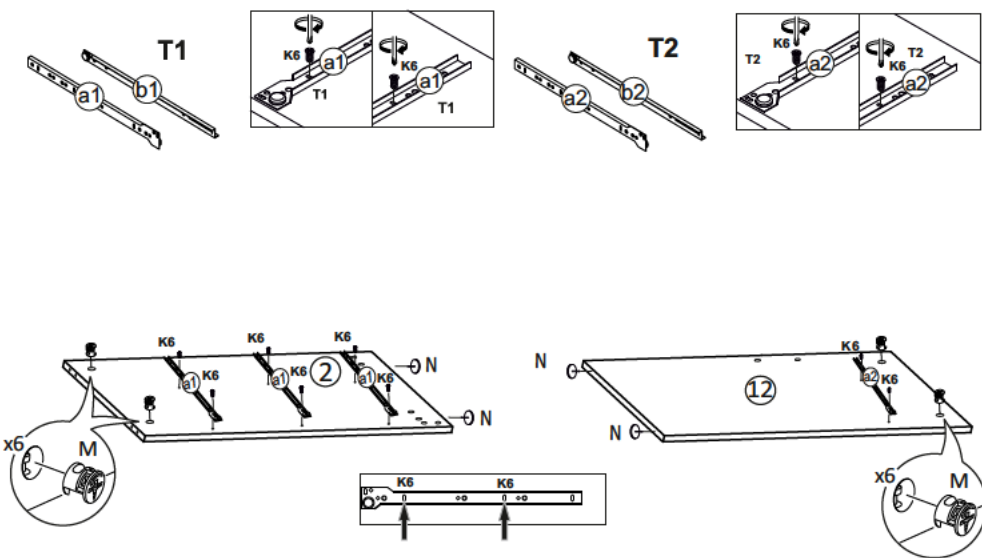

2 **8X30** 1x26 **MB** x6

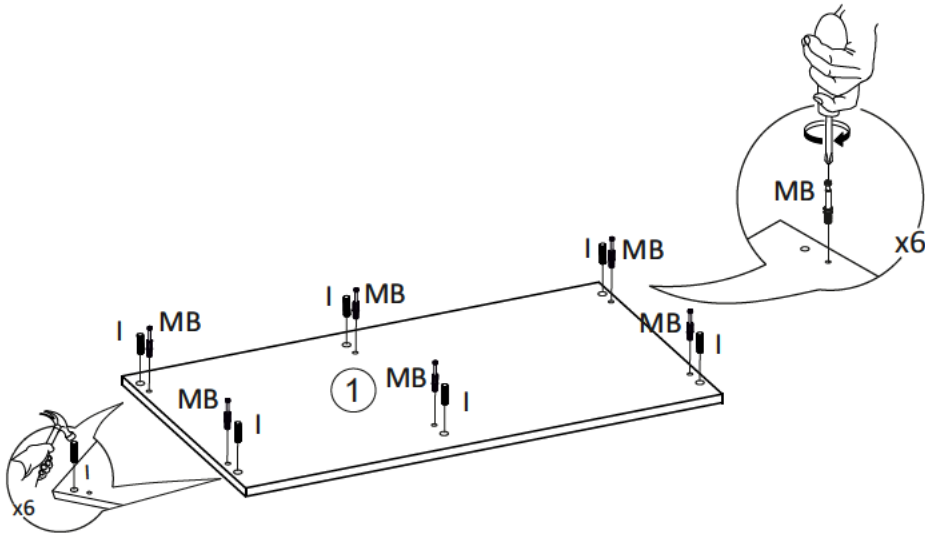
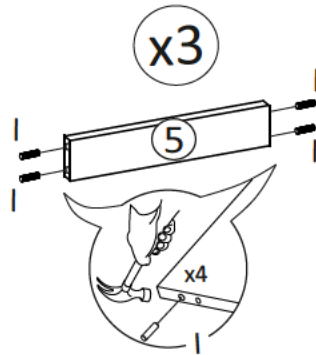
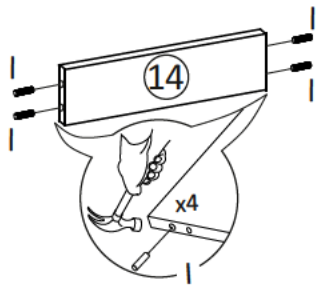
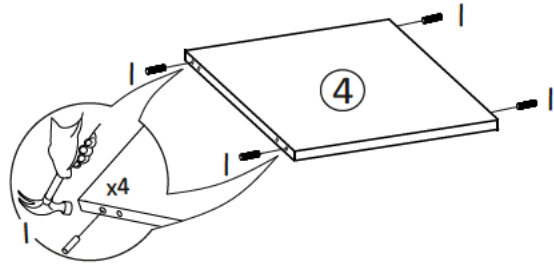

3 **Kz** x8 **KK** x1 **K** x8

