























DIMENSIONS



PARTS LIST

PARTS LIST			HARDWARE LIST		
NO	DESCRIPTION	QTY	NO	DESCRIPTION	QTY
①		1	A		30
②		1	B		30
③		1	C		30
④		1	D		14
⑤		1	E		4
⑥		1	F		36
⑦		1	G		12
⑧		1	H		6
⑨		1	I		4
⑩		2			
⑪		2			
⑫		2			
⑬		2			
⑭		2			

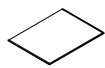
ASSEMBLY DIAGRAM

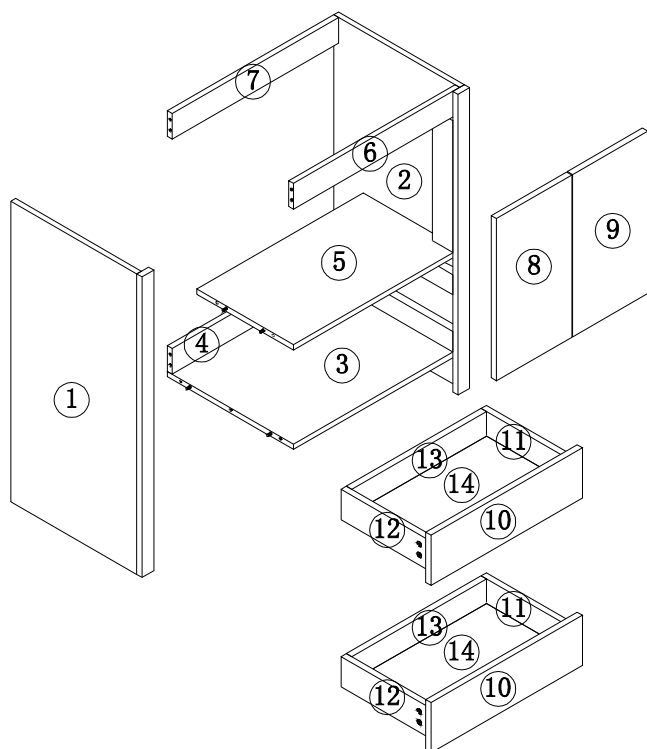

CAUTION: Please confirm the parts list before installation

YOU MAY NEED (NOT SUPPLIED)

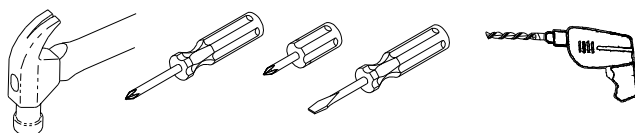

INSTALLATIONS

STEP 1

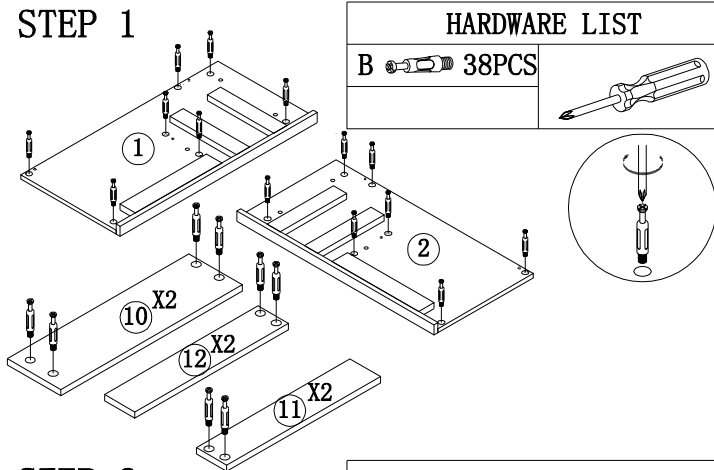

STEP 2

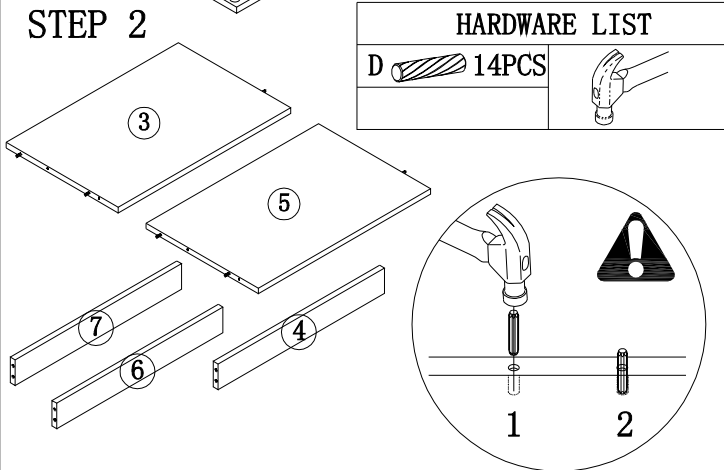

STEP 3

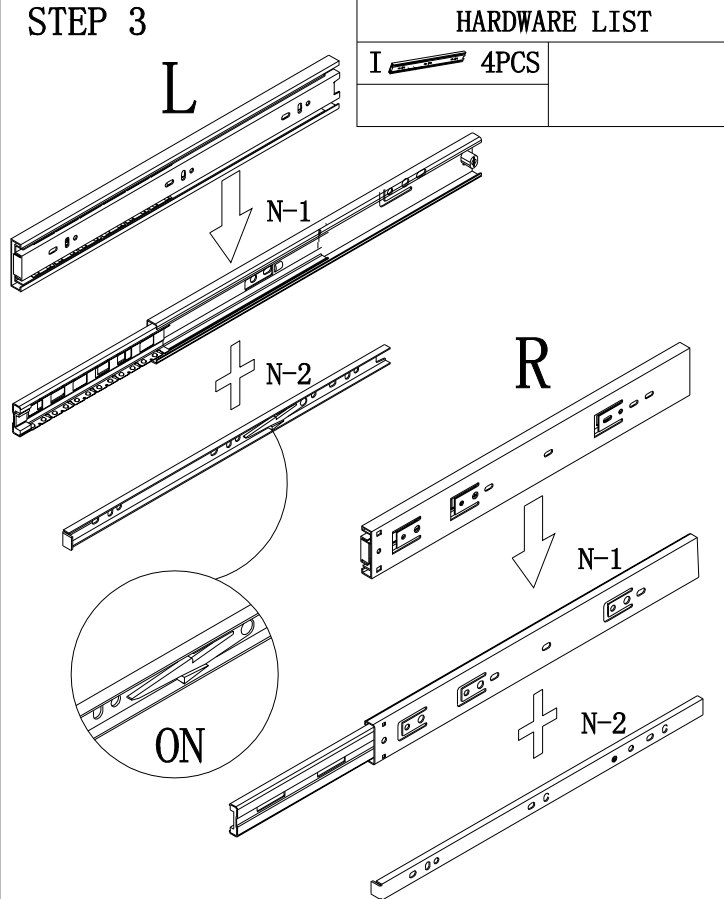

STEP 4

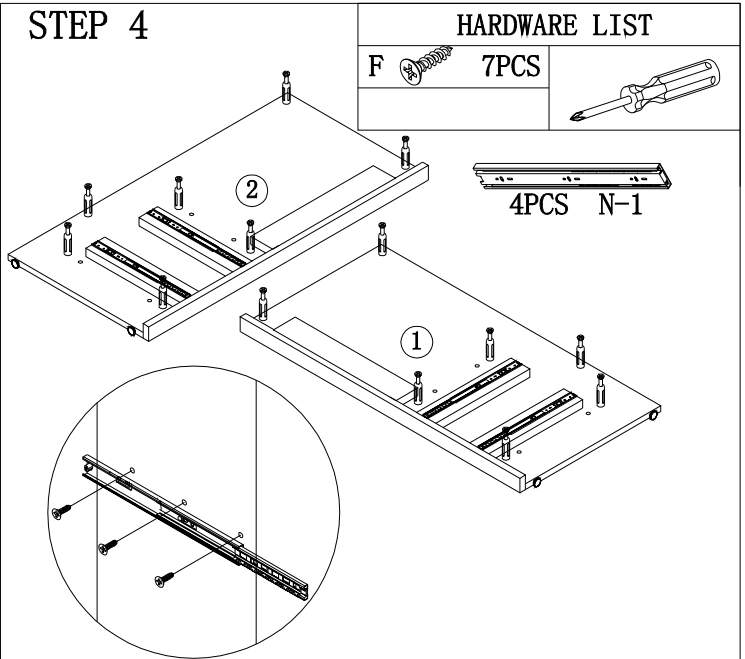

STEP 5

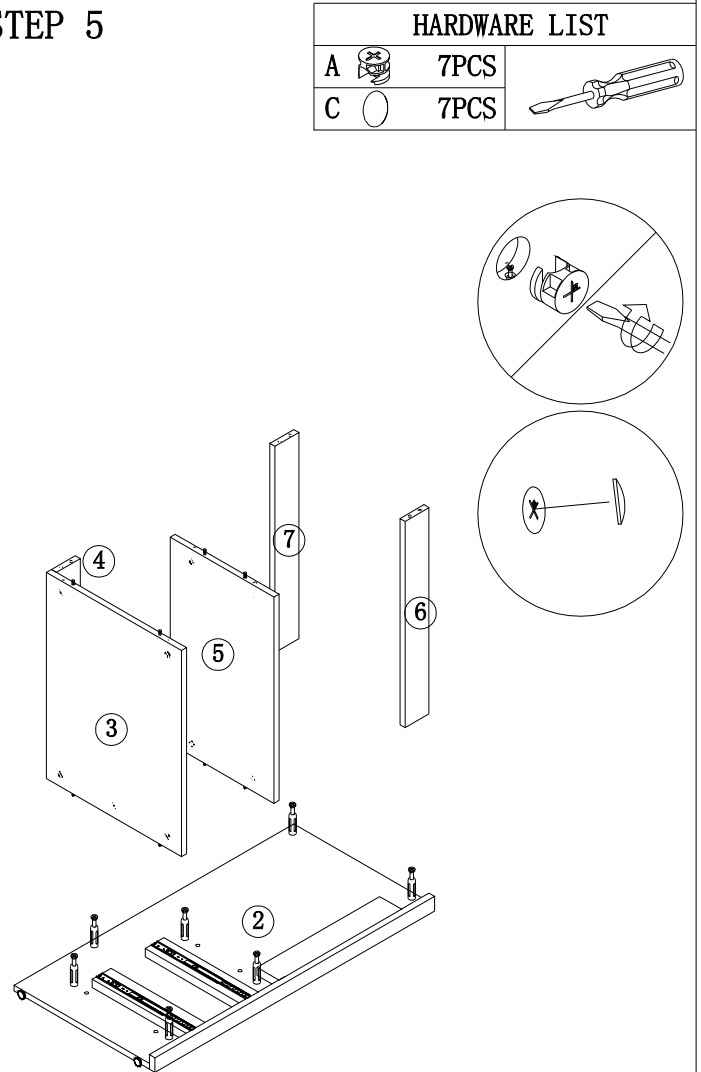

STEP 5

HARDWARE LIST

A		7PCS
C		7PCS

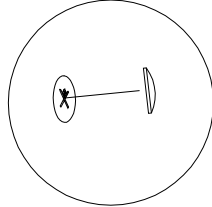
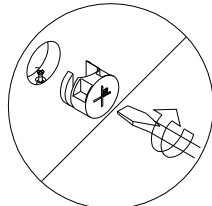
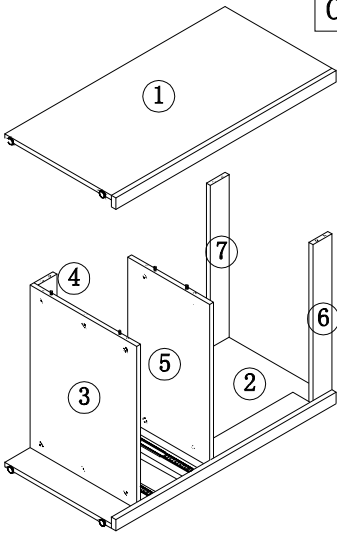
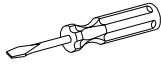

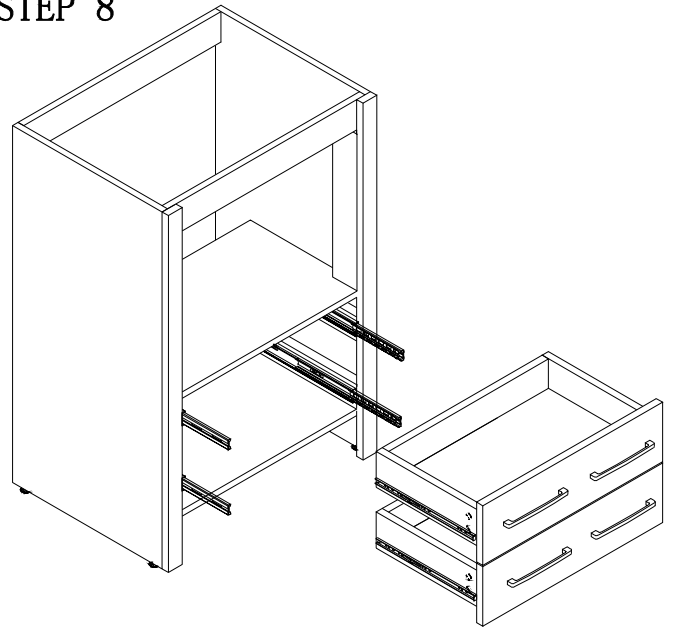

STEP 8



STEP 6



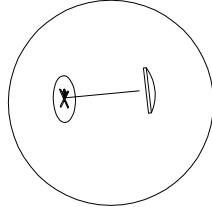
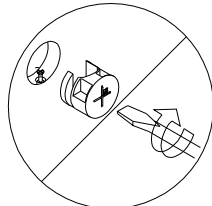
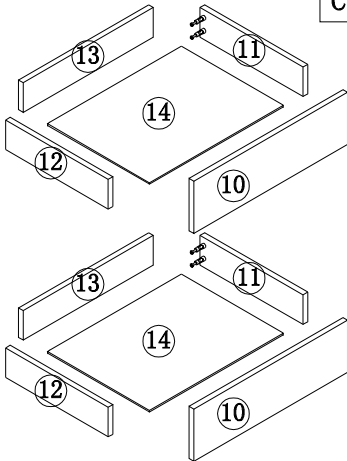
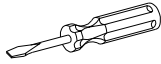

HARDWARE LIST

A		16PCS
C		16PCS



STEP 9

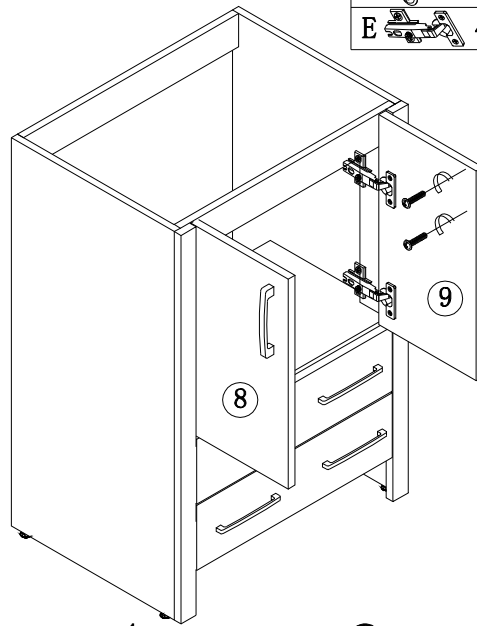
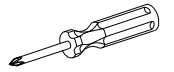

HARDWARE LIST

F		24PCS
H		2PCS
G		4PCS
E		4PCS



STEP 7

HARDWARE LIST

F		12PCS
G		8PCS
H		4PCS

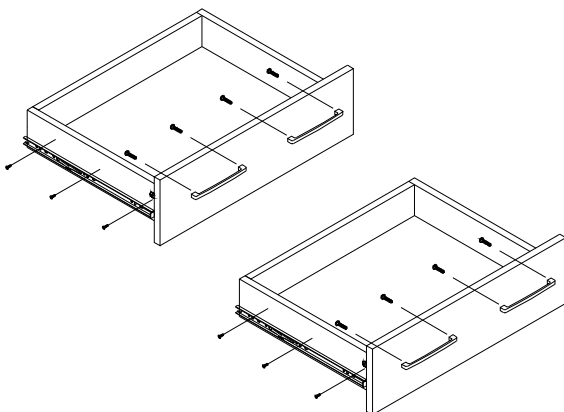
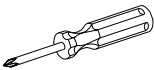

1

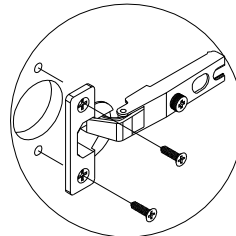

2

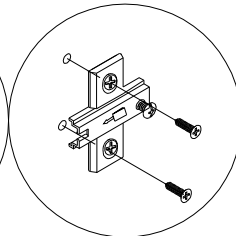

3

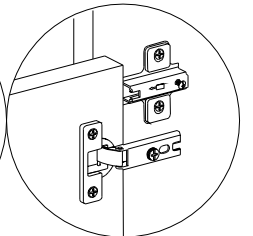

4

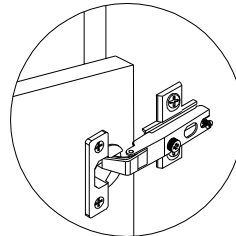

5

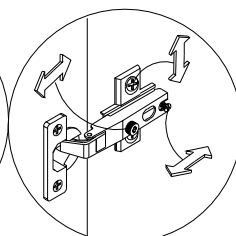

STEP 10

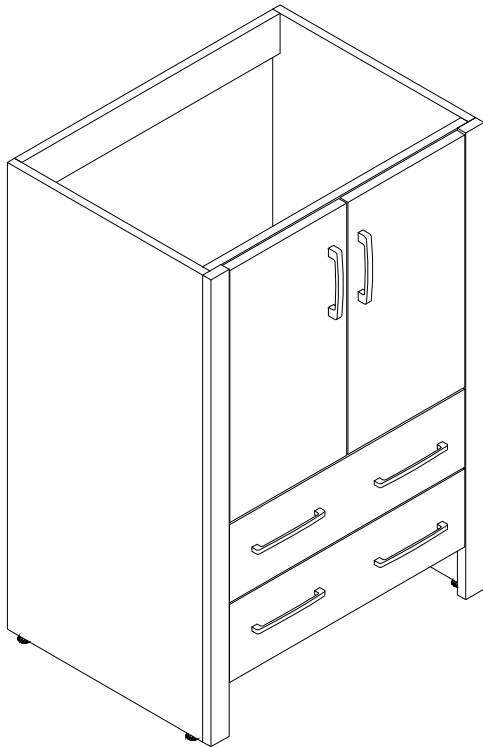

Choking hazard-Small Parts : This unit contains small parts, not for children under 3 years.

Tip-over hazard : Secure finished unit to wall stud using L-Bracket and wall screw (#10*1.5"W/out provided). If a wall stud is

not neccessible ,Consault your local hardware store for appropriate mounting hardware . Failure to properly install will result in product collapse or tip-over. Serious injury can occur .