

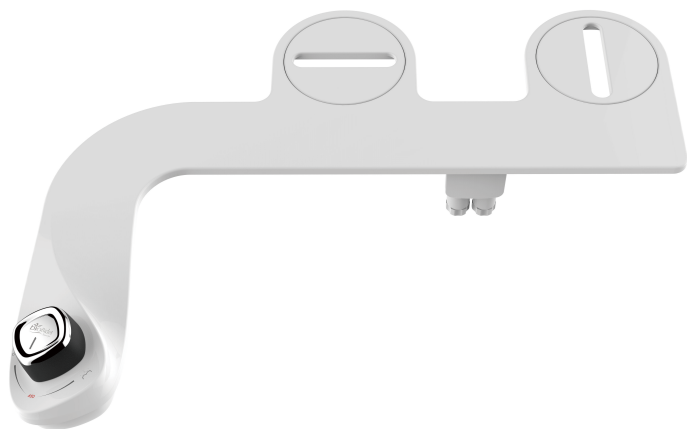

OWNER'S MANUAL
SlimEdge

SlimEdge

Bidet Attachment



Clean in Comfort

Table of Contents

PRODUCT INFORMATION

Features. Page 2

Parts List. Page 3

Dimensions. Page 4

PRODUCT INSTALLATION

Pre Installation. Page 5

Installing the Bidet Attachment Page 5

PRODUCT OPERATION

How to use the SlimEdge Page 9

MAINTENANCE

Cleaning Page 9

Short Term Non-Use Page 9

Warranty. Page 10

CONTACT Page 11

PRODUCT INFORMATION

FEATURES

- Industry's first Relax Panel
- Comfort Grip Control Dial
- High-quality ABS material with full body panel
- Premium quality with all metal inlet and installation parts
- Dual Nozzle
- Ambient temperature bidet wash
- Adjustable water pressure
- Unified Internal Brass Valve
- High-quality metal 7/8" T-valve
- Durable braided metal cold water hose
- No electricity or batteries required
- Easy installation and adjustable toilet fit
- All accessories included for standard installation
- One-year warranty

PARTS LIST

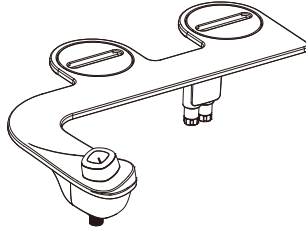

Bidet attachment with tilted outward knob

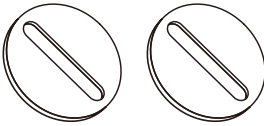

Adjustable mounting brackets (2)

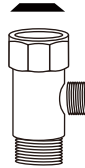

**T-Valve connector with included rubber cone washer
(7/8" x 7/8" x 3/8")**

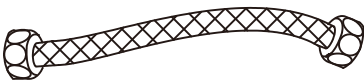

27.5" braided metal bidet hose



non-slip mat (2)

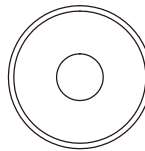

Teflon Tape

PRODUCT INFORMATION(cont.)

DIMENSIONS

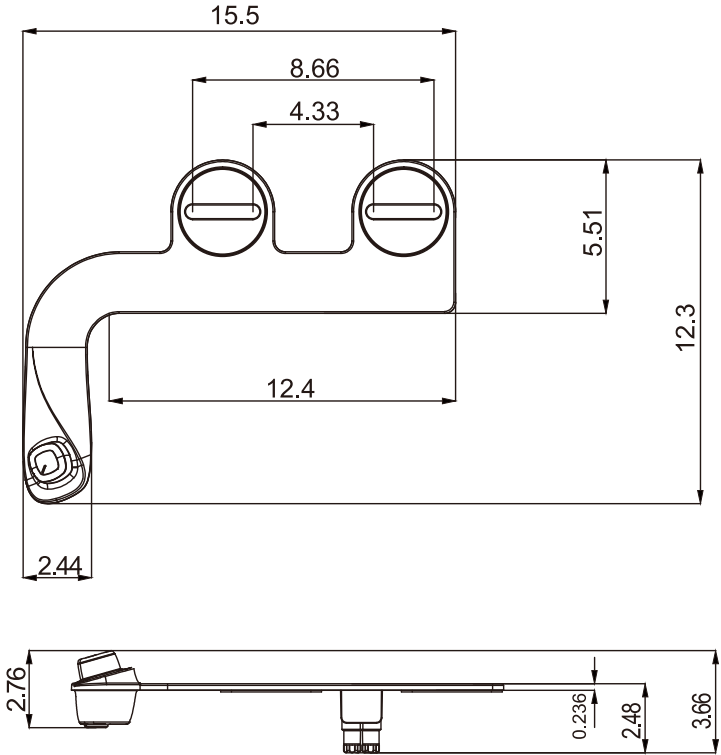

PRODUCT INSTALLATION

PREINSTALLATION

IMPORTANT

Please be advised that the provided T-Valve should be installed at the fill valve under the toilet tank, NOT down at the water supply coming from the wall.

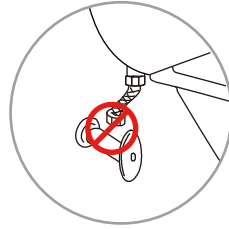

If you do not have access to the fill valve under the toilet tank, contact Biobidet Customer Service at 847.458.2334 and we may be able to provide alternative fittings.

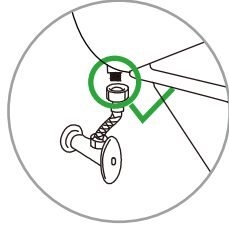

Check Water Supply Line

Inspect your current water supply line that connects to the toilet tank fill valve to ensure it is a flexible water supply hose. If it is a rigid pipe, you will need to purchase a flexible water supply hose before installing the SlimEdge. The hose needs to be 7/8" (to connect to the T-valve we provided) on one end and either 3/8" or 1/2", depending on your wall valve, on the other end.

INSTALLING THE SlimEdge

1. Remove the existing toilet seat by locating the bolts and nuts, typically under a plastic cover, and removing them first.



Step 1

PRODUCT INSTALLATION(cont.)

INSTALLING THE SlimEdge(cont.)

2. Close the water supply valve and flush the toilet completely so that there is little to no water left in the toilet tank.

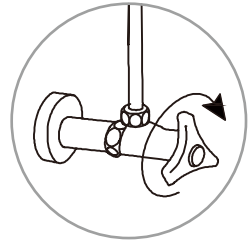

Step 2

3. Disconnect the water hose from underneath the toilet tank.

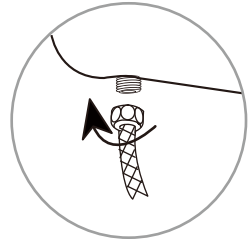

Step 3

4. Connect the 7/8" T-valve to the toilet fill valve where you just removed the water hose from.

a. Make sure the rubber washer is properly seated and the narrow side is up.

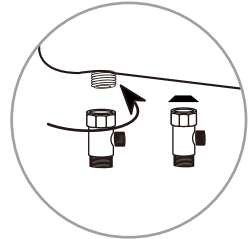

Step 4

5. Attach the water supply hose that comes from the water shut off to the bottom of the T-Valve.

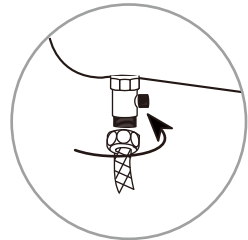

Step 5

INSTALLING THE SlimEdge(cont.)

6. Connect the metal hose we supplied to the open side of the T-valve.

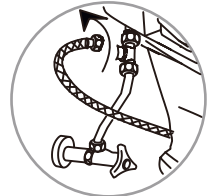

Step 6

7. Insert the rubber non-slip mats to the bottom of the bidet and place the circular mounting brackets into the bidet attachment.

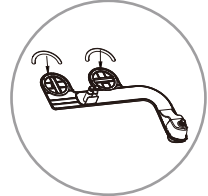

Step 7

8. Place the bidet on the toilet with the mounting brackets over the mounting bolt holes and make any needed adjustments to make sure the bidet is centered on the toilet and so you can see the mounting bolt holes through the mounting brackets of the bidet.

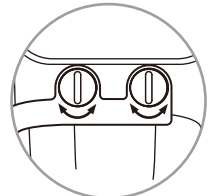

Step 8

PRODUCT INSTALLATION (cont.)

INSTALLING THE SlimEdge(cont.)

9. Place the toilet seat back on the toilet over the bidet and secure the bolts down so that the seat and bidet attachment are stable.



Step 9

10. Connect the hose from step 6 to the bidet water connection underneath the handle of the SlimEdge.



Step 10

11. Slowly turn the water supply valve back on and check for leaks and test the unit for functionality.

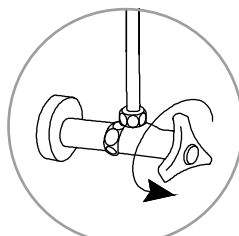

Step 11

12. If there are no immediate leaks, check again in about 5-10 minutes and your SlimEdge is ready for use!

Note:

If any leaks occur, check all rubber washers and make sure all connections are tight and secure.

PRODUCT OPERATION

HOW TO USE THE SlimEdge

For back wash turn the control knob to the left towards the " " position

For front/feminine , turn the control knob to the right towards the " " position.

- The further the knob is turned, the higher the water pressure will be.

CLEANING THE SlimEdge

Your SlimEdge is made with a higher grade fire-retardant ABS resin. Using hard cleaning chemicals can weaken the material causing it to damage and develop cracks.

- Clean the SlimEdge by wiping the surface area with a damp cloth regularly.
- Do not use harsh detergents or any cleaning tools with bristles on your bidet. Steam cleaning is the preferred cleaning method for your bidet. For a deep, chemical free clean, consider the BioMist Bidet Cleaner.

SHORT TERM NON-USE

If the product will not be used for more than a few days , it is highly recommended that the water supply valve is turned off.

Warranty

Your Bio-Bidet,

Is warranted against defects in materials or workmanship for one (1) year from the Date of original purchase. Defective parts or a defective product returned to Bio Bidet will be repaired with new or comparable rebuilt parts or exchanged for a Refurbished Bio-Bidet as determined by Bio Bidet in their sole discretion.

This limited warranty given by Bio Bidet covers all defects encountered in normal use of Bio-Bidet, and do not apply in the following cases:

- 1 Loss of or damage to Bio-Bidet due to abuse, misuse, tampering, mishandling, improper packaging by you, alteration and fail to follow operating instructions.
- 2 Use of parts or supplies (other than those by Bio Bidet's dealers) that cause damage to Bio-Bidet.
- 3 Replacement of discolored or stained parts caused by chlorine, bleach, ammonia and other chemicals, cleaning supplies, oxidation, normal wear and tear.
- 4 Damage to or malfunction of the unit as a result of improper and negligent installation.
- 5 Any and all damages to plumbing, walls, floors, ceiling and personal properties resulting from water leaks or breakage. The product must be used at the user's own risk. Therefore, the owner hereby releases the manufacturer and distributor from any and all claims for damages where the above condition exists.

No implied warranty, including any implied warranty of merchantability or fitness or a particular purpose, applies to BBC innovation bidet after the applicable period of the express limited warranty stated above, and no other express warranty or guaranty, except as mentioned above, given by any person or entity with respect to Bio-Bidet shall bind Bio Bidet, (Some States and provinces do not allow limitations on how long an implied warranty, so the above limitation may not apply to you) BBC innovation shall not be liable for revenues or profits, inconvenience, expense for substitute equipment or service, or any other special, incidental or consequential damages caused by the use or misuse of, or inability to use, Bio-Bidet, regard-less of the possibility and foresee-ability of such damages. In no event shall recovery of any kind against BBC innovation be greater in amount than the purchase price of the product and causing the alleged damage. Without limiting the foregoing, you assume all risk and liability for loss, damage or injury to you and your property and to others and their property arising out of use or misuse of ,or inability to use, the Bio-Bidet not caused directly by the negligence or BBC innovation This limited warranty shall not extend to anyone other than the original purchaser of the Bio-Bidet

Thank you

Technical Support /Customer Service
Bio Bidet
7900 S Route 31 Crystal Lake IL 60014
T :847.458.2334
U.S TOLL FREE :877.339.5214

support@biobidet.com
www.biobidet.com