

ASSEMBLY INSTRUCTION

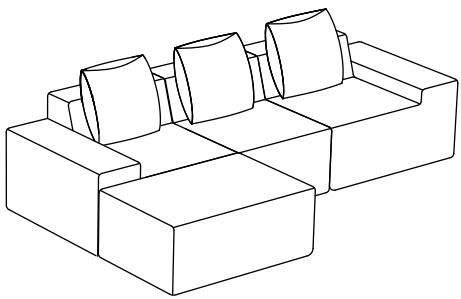

Left Side Facing Chaise

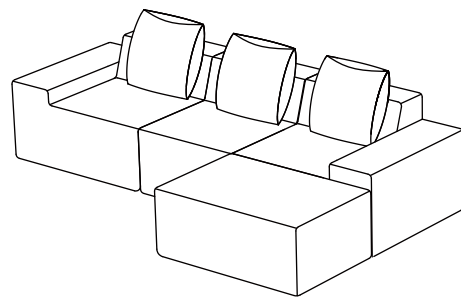

Right Side Facing Chaise

A Left Armchair

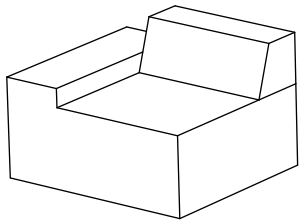

x1

B Right Armchair

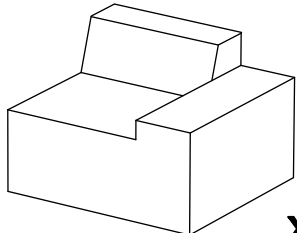

x1

C Armless Chair

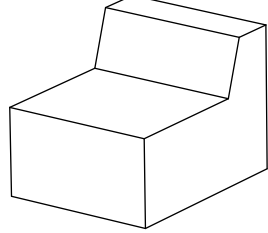

x1

D Ottoman

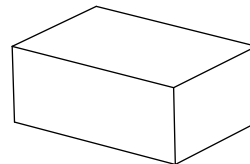

x1

E Back cushion

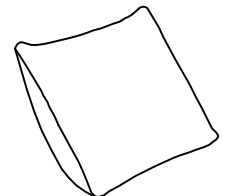

x3

Step 1:

Attention:

The first step, do not use a knife to go deep into the box to open it, be careful not to cut the sofa. Please use safety blade(G) to open the packages.

G Safety blade

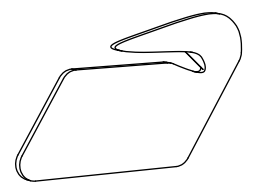

x2

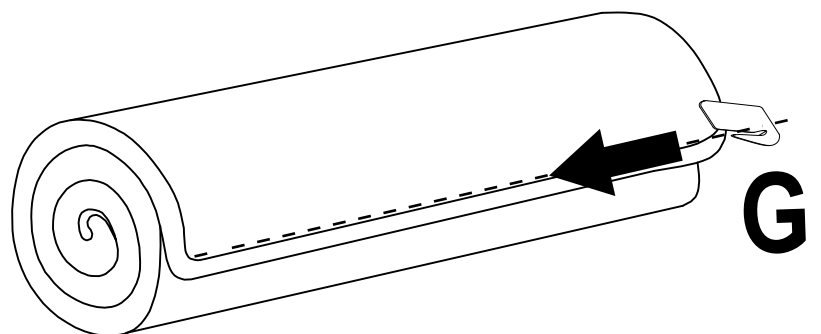
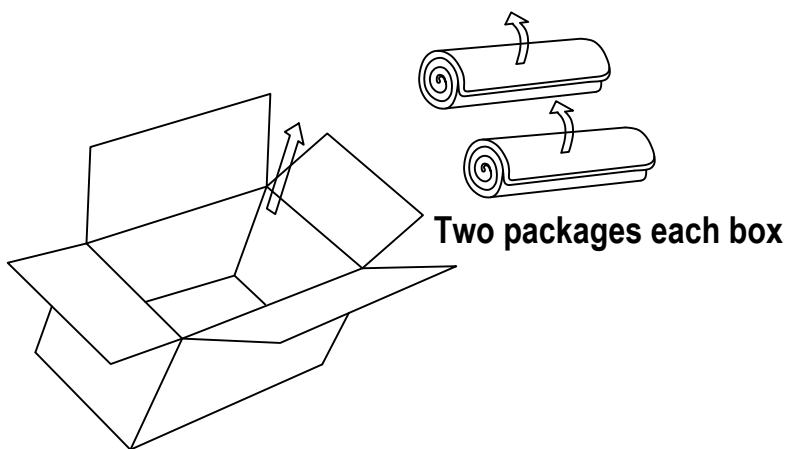

Carton 1/2:

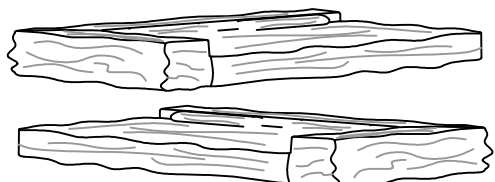

A
B

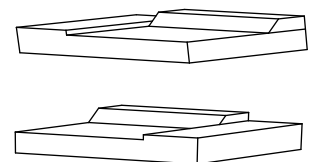
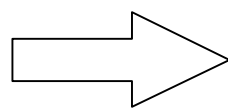

A
B

Carton 2/2:

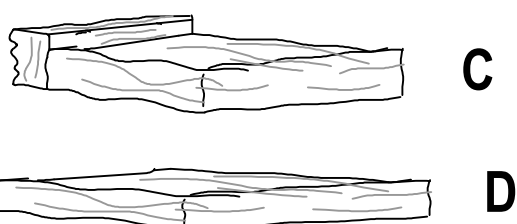

C
D

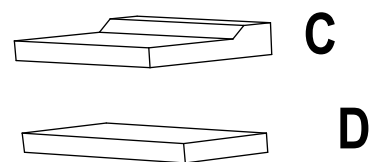
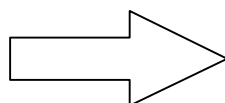

C
D

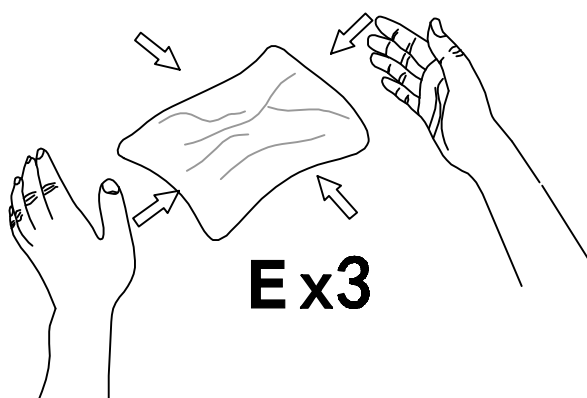
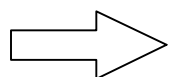
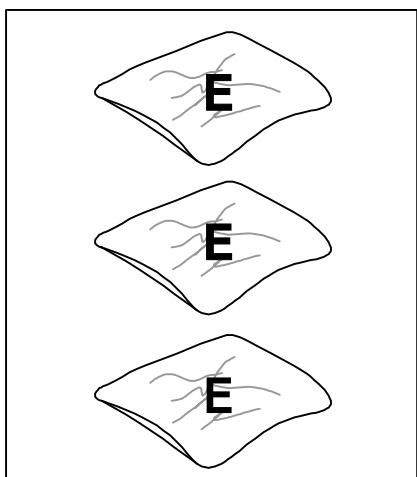

E x3

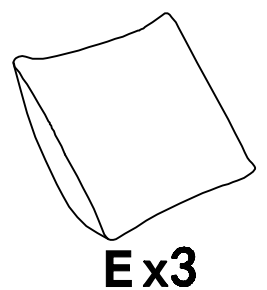
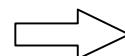

E x3

Tap the back cushion according to the picture.

Step 2:

Attention:

The second step, open the compressed closed plastic bag to make the product expand, flap all parts of the sofa's surface with your hands, let the air enter the sofa sponge fully, and then use your hands to follow the knitting direction of the cloth to make the sofa color consistency.

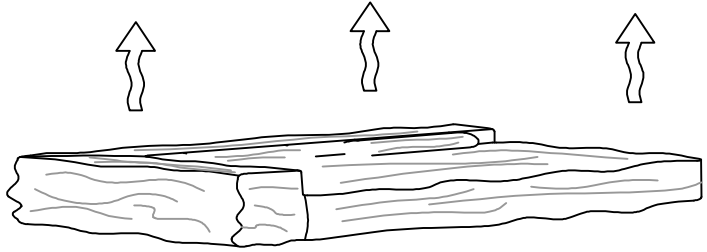

Ax1

Please wait for 72 hours

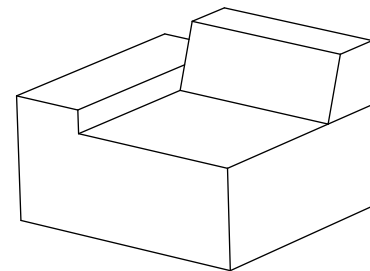
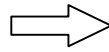

Ax1

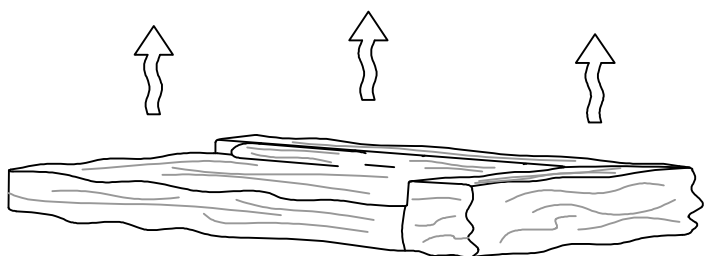

Bx1

Please wait for 72 hours

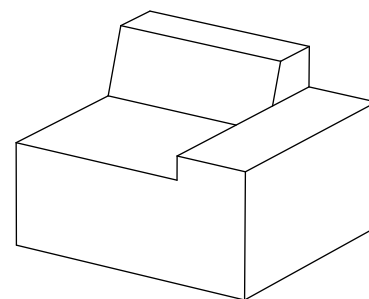
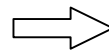

Bx1

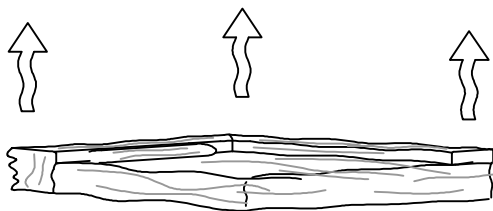

Cx1

Please wait for 72 hours

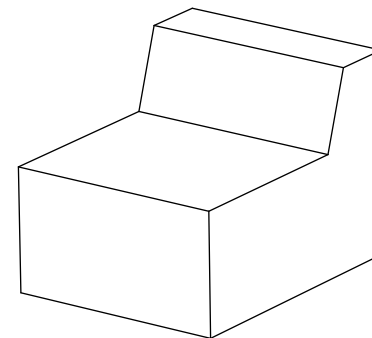
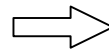

Cx1

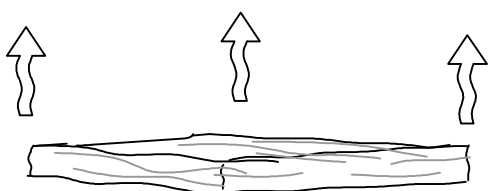

Dx1

Please wait for 72 hours

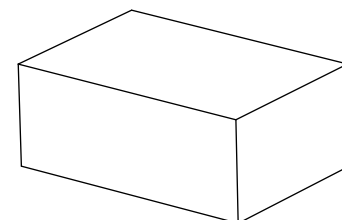

Dx1

Step 3:

