

Assembly Instruction

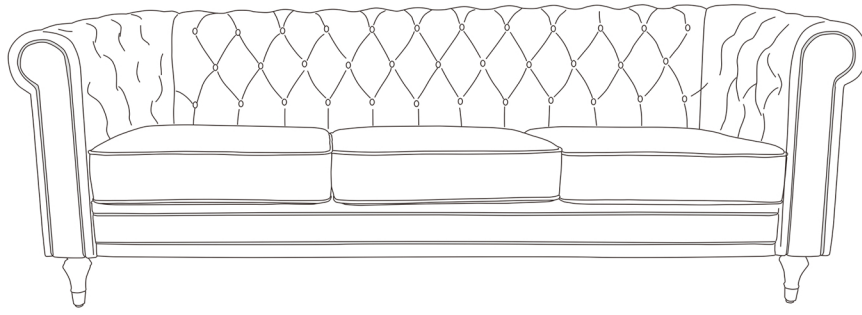

Box 1

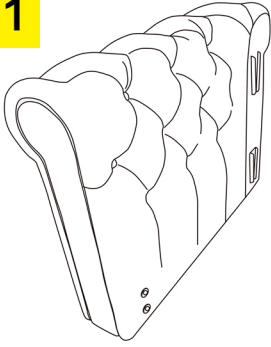

A:left armrest x1pcs

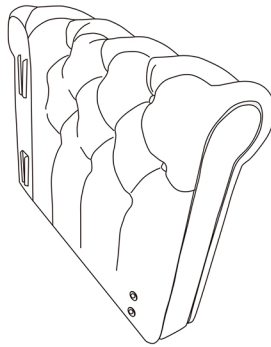

B:right armrest x1pcs

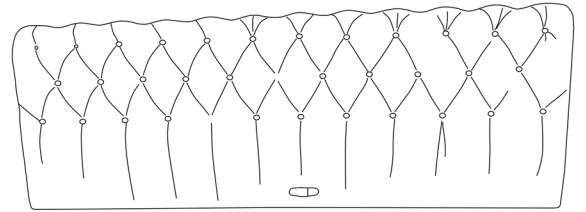

C: sofa back x1pcs



D: front board x1pcs

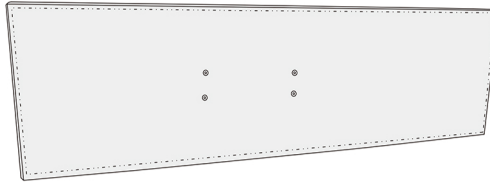

E: seat board x1pcs

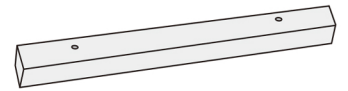

F:side bar x2pcs

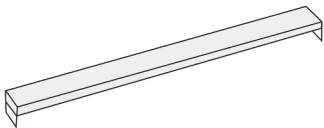

G: mid bar x1pcs

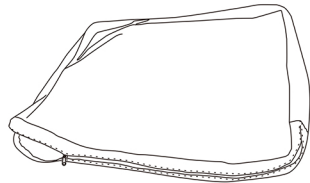

I: seat cushion cover

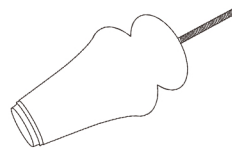

J: leg x4pcs

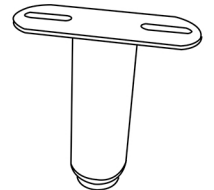

K: mid leg x2pcs



L: angle bracket(L)
x1pcs



M: angle bracket(R)
x1pcs

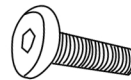

N:M6*20MM
x10pcs



O: M6*60MM
x4pcs



P: washer x8pcs



Q: hex key x1pcs

Box 2

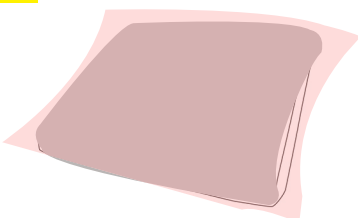

H:seat cushion x3pcs

Step 1 Insert the backrest to each armrest.

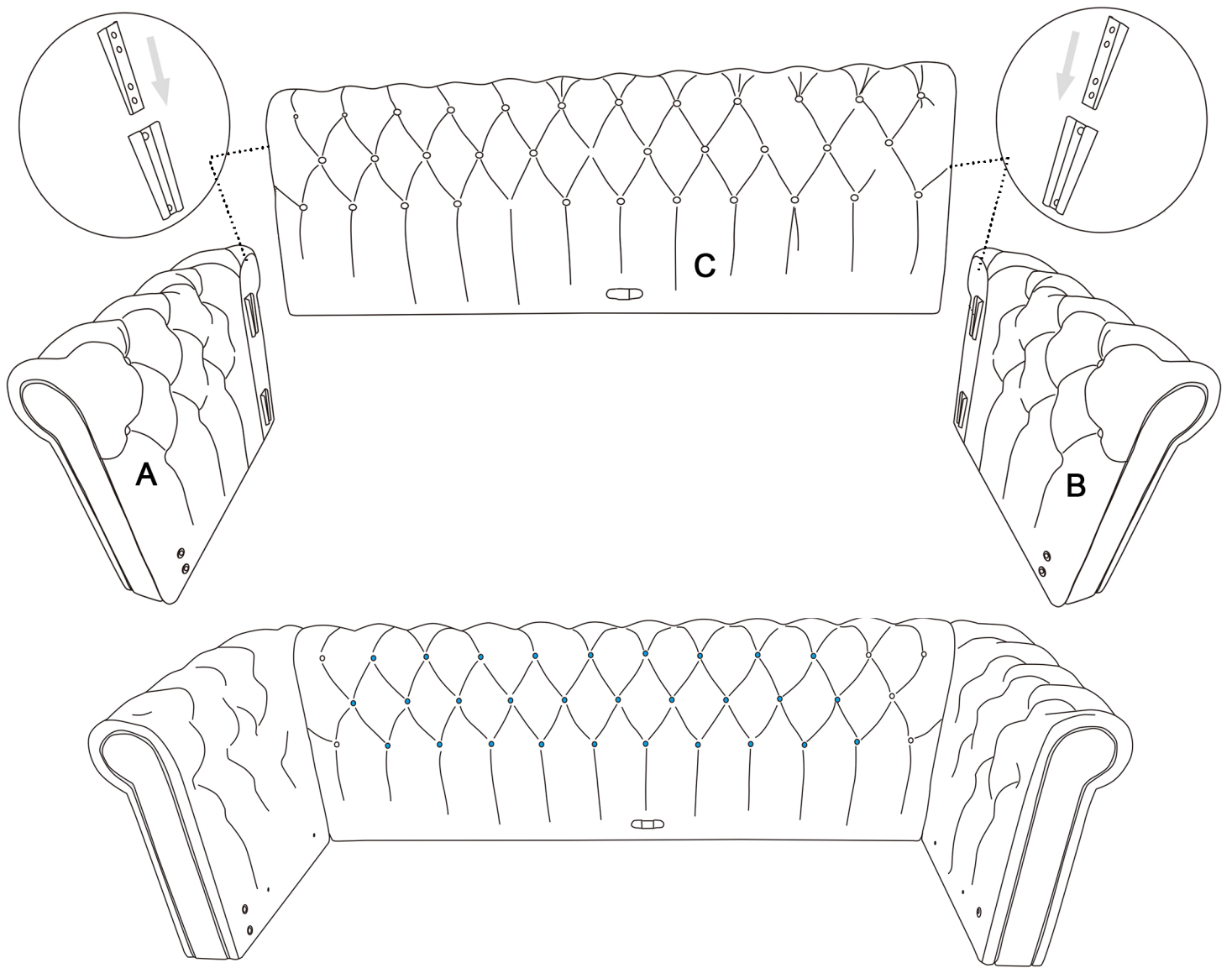

Step 2 Install the angle brackets to both side of the front board.

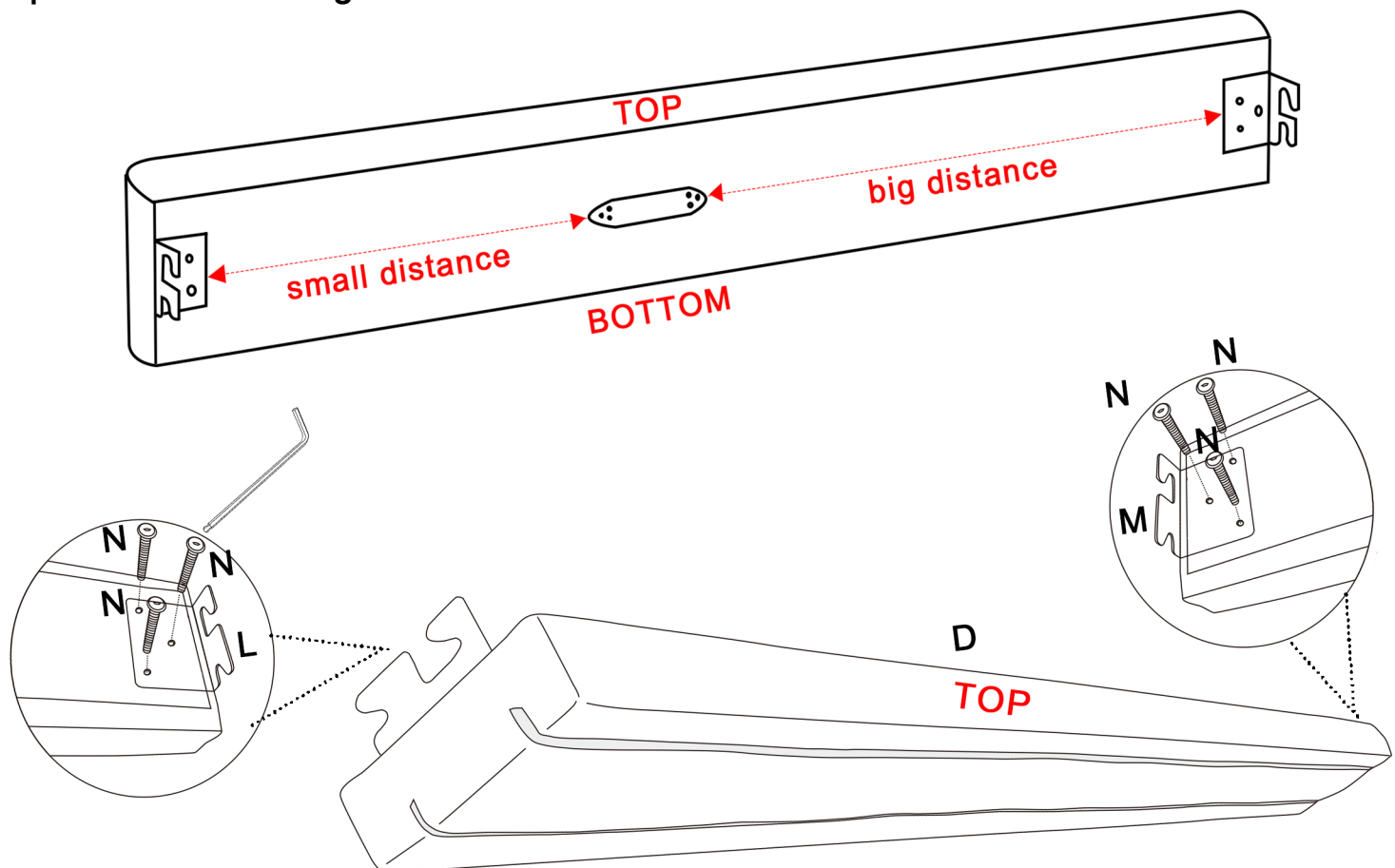

Step 3 Install the front board and fasten to both armrest.

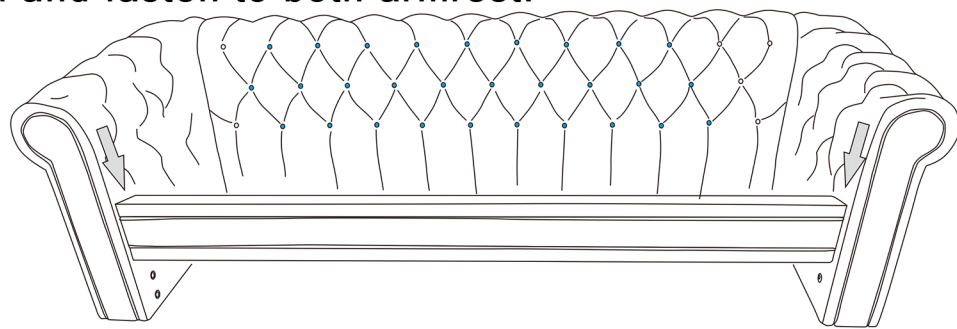

- 1)unscrew the bolt 50%
- 2)both brackets hook on the bolts
- 3)tighten the bolts

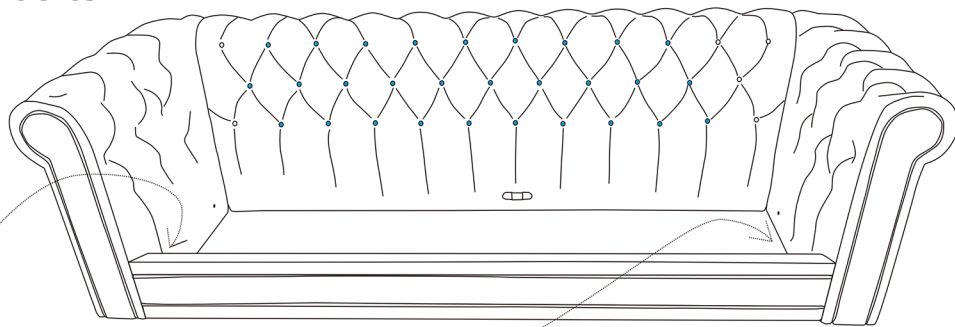
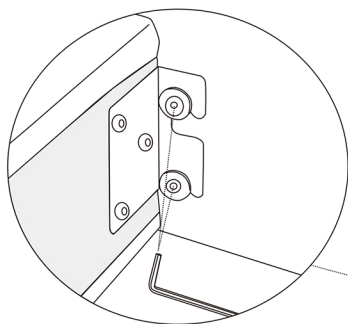

Step 4 Install the side bar on each armrest.

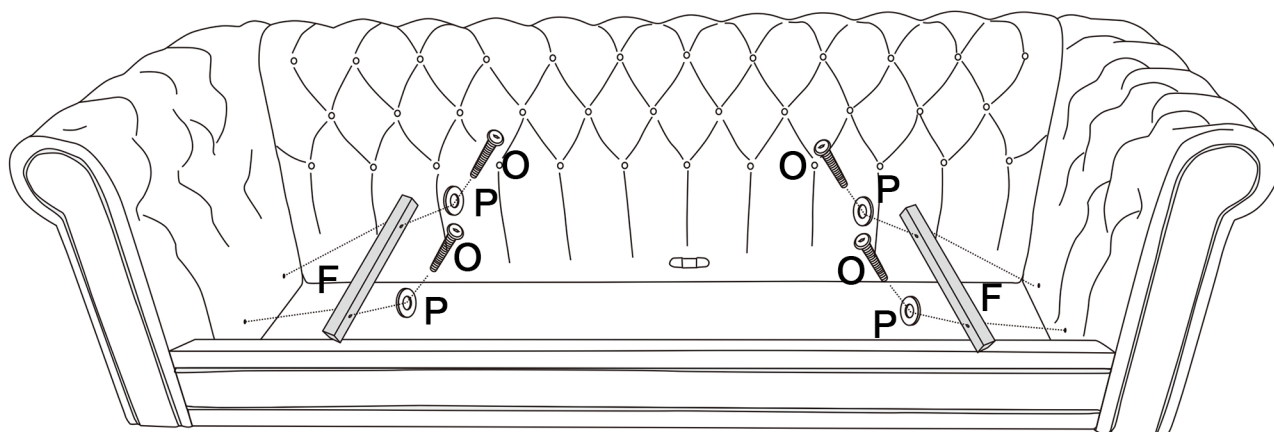

Step 5 Install the mid bar.

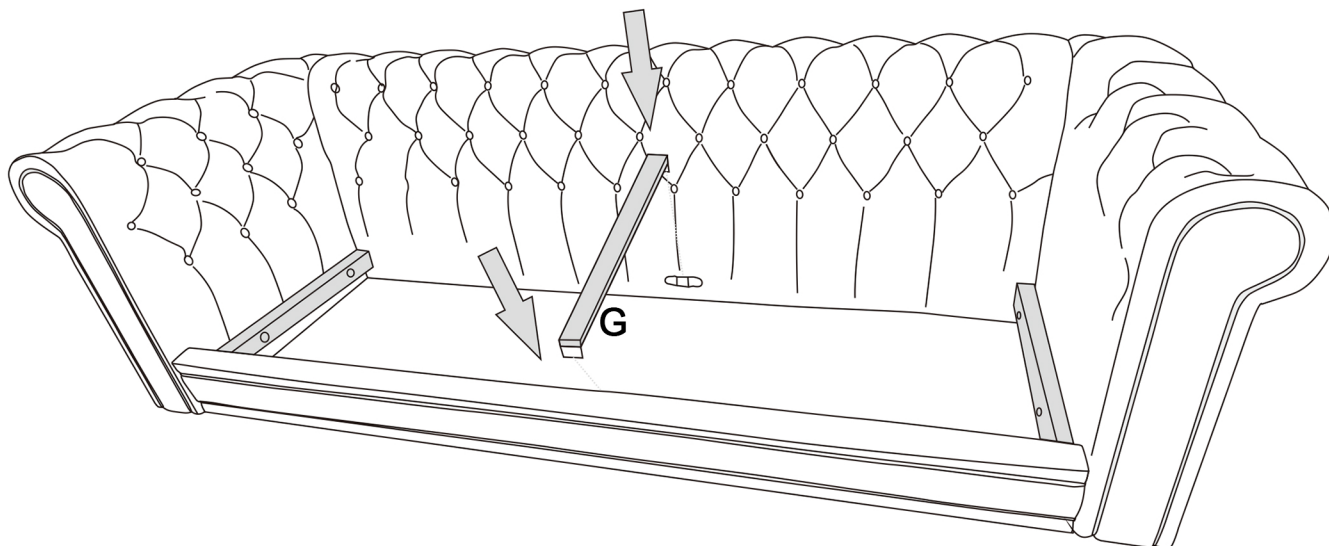

Step 6 Install the legs as following.

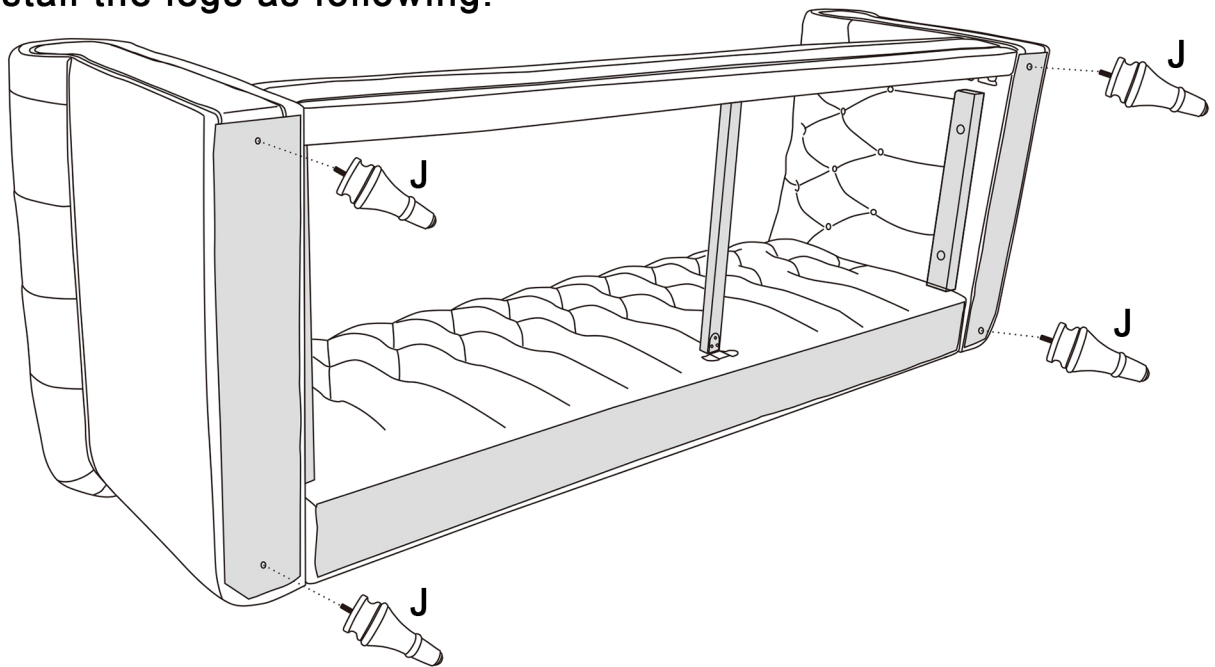

Step 7 Install the mid legs on the seat board.

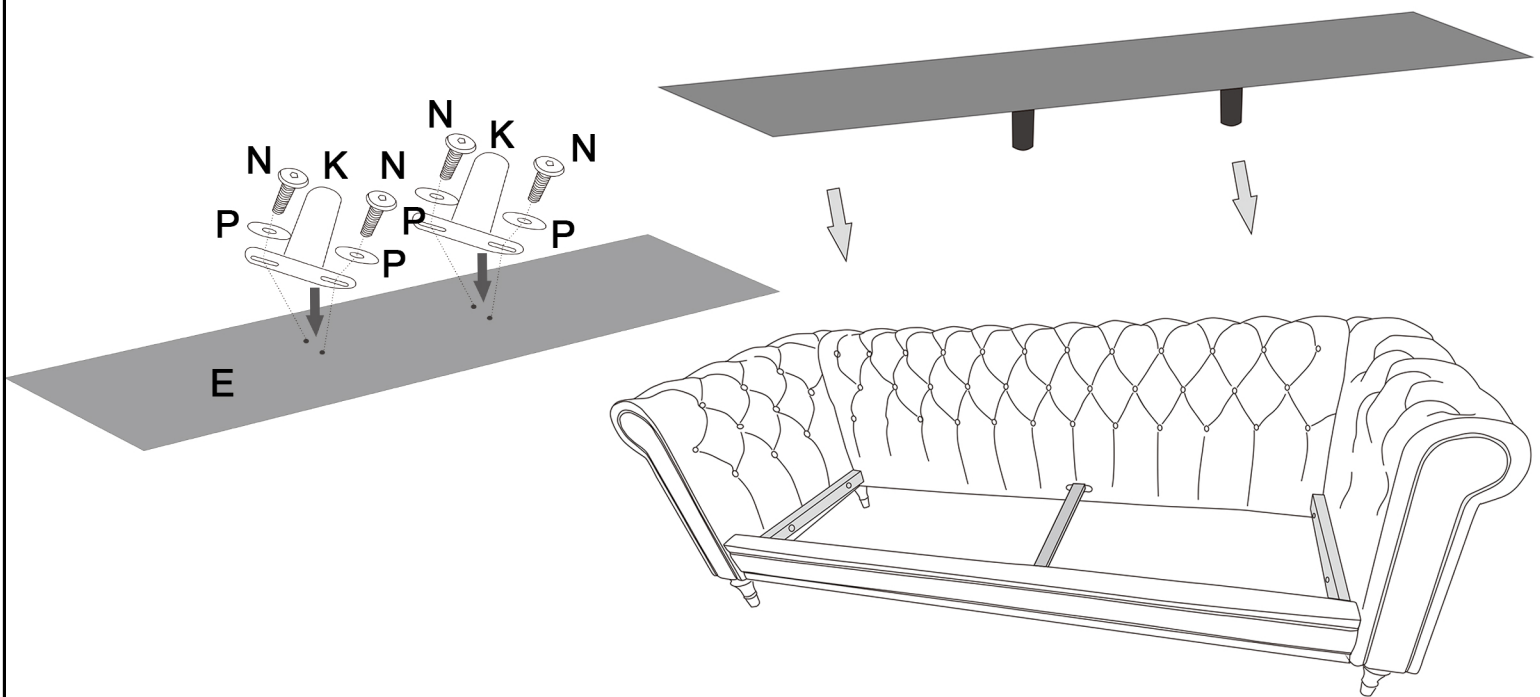

Step 8 Install the seat cushions.

Finish

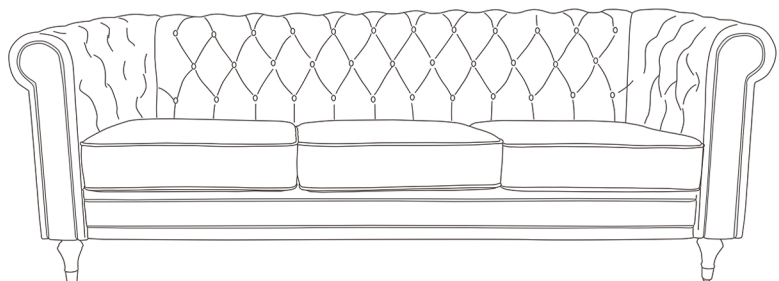
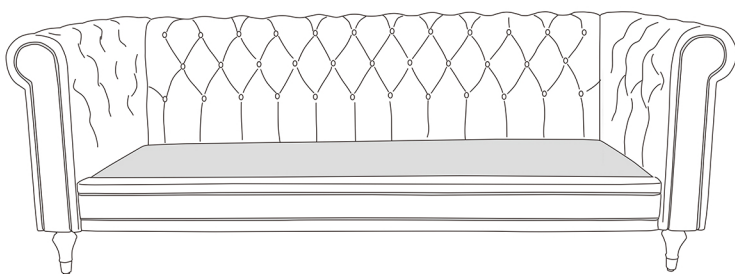
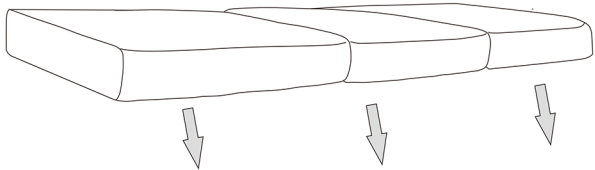

How to install the cushions

Step 1. Open the plastic bag and remove the cushions foam wrapped with polyester fiber & non-woven bag from the plastic bag.

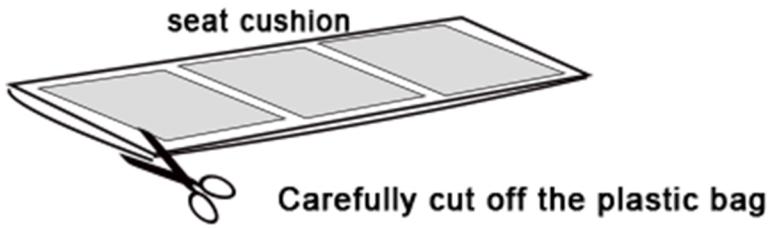

Step 2. Cover the fabric covers to all cushions foam. **PLEASE DON'T REMOVE THE NON-WOVEN BAG & POLYESTER FIBER OF THE SEAT CUSHIONS, PLEASE KEEP IT AS IT IS.** When you get the seat cushions, you will see the RED words which side is the **Top**, **Front** and **Back** as following.

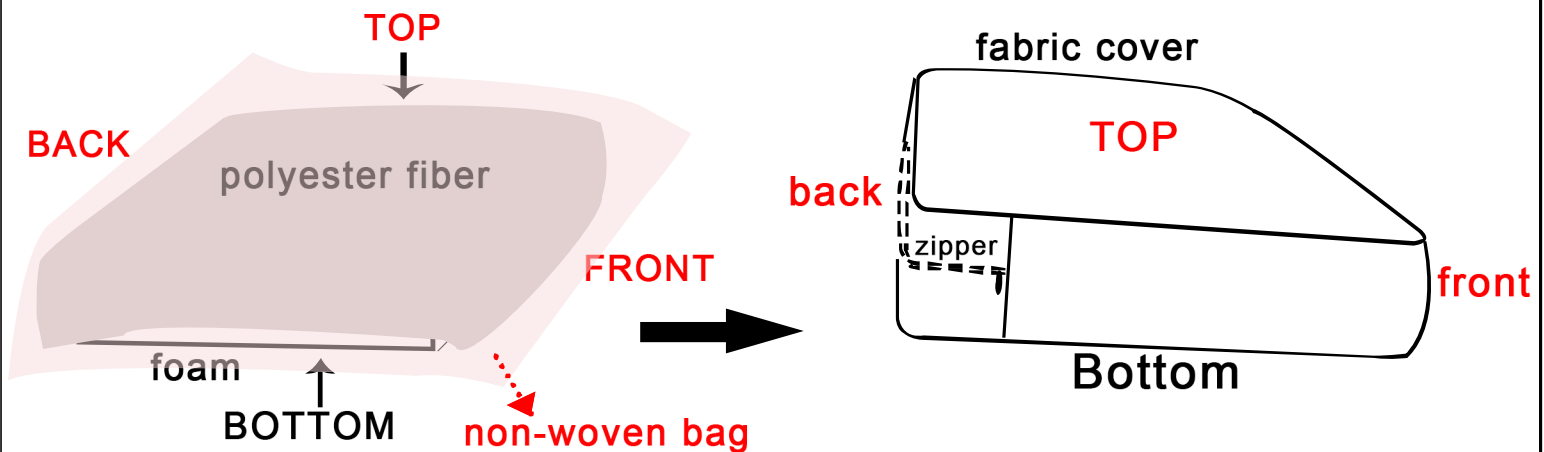

How to tidy sofa seat cushion?



TIPS

At the beginning all cushions are a little loose which is normal. Please allow at least 72 hours for all cushions foam to recover to its natural state after covering the fabric covers.