

# Product Assembly Instructions [ Product Model: FS120-1200 ]

List:

Part	Description	Quantity
A	Main Product	x1
B	Support	x2
C	Expansion Bolt	x8

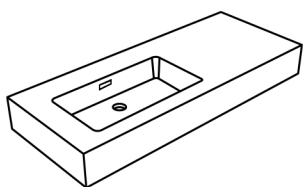

**A**

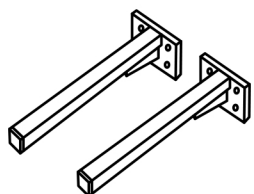

**B**

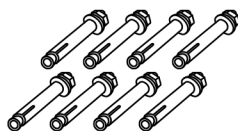

**C**

Tools Required:

Part	Description
A	Drill bit
B	Pencil
C	Wrench
D	Electrodrill
E	Gradienter
F	Adhesive



**A**

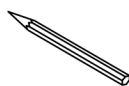

**B**

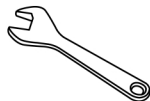

**C**



**D**

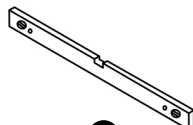

**E**

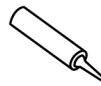

**F**

Installation Steps : 1

Measure the distance of the mounting holes, and the height you want, mark with the pencil.

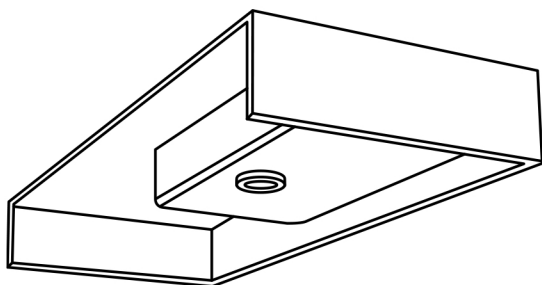

The back of the product

Installation Steps : 2

Drill holes with a suitable sized drill.

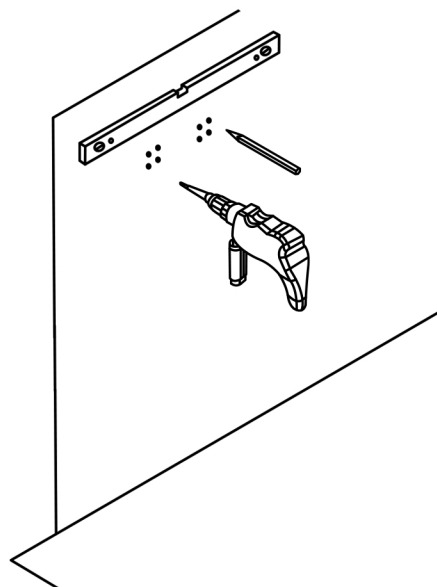

Installation Steps : 3

Insert the wall plug and mount screws into the wall. Install the brackets. Put some glue on the surface of brackets.

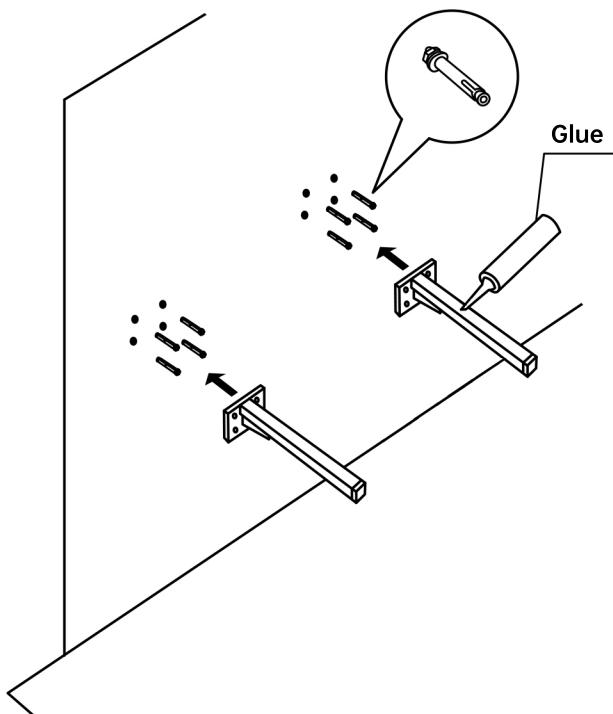

Installation Steps : 4

Install the product onto the stand.

