

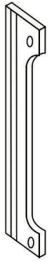









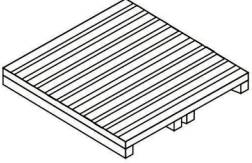
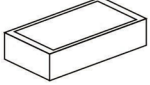

 A1x1	 A2x1	 Bx1	 Cx1	 Dx1
 Ex1	 Fx1	 Gx2	 Hx1	 Ix1
 I1x1	 I2x1	 I3x1	 I4x1	 Jx1
 Kx4	 Lx16	 Mx1	 Nx2	 Ox1

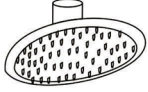

3

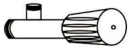
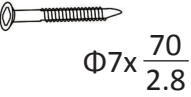
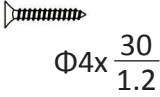

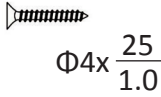
4

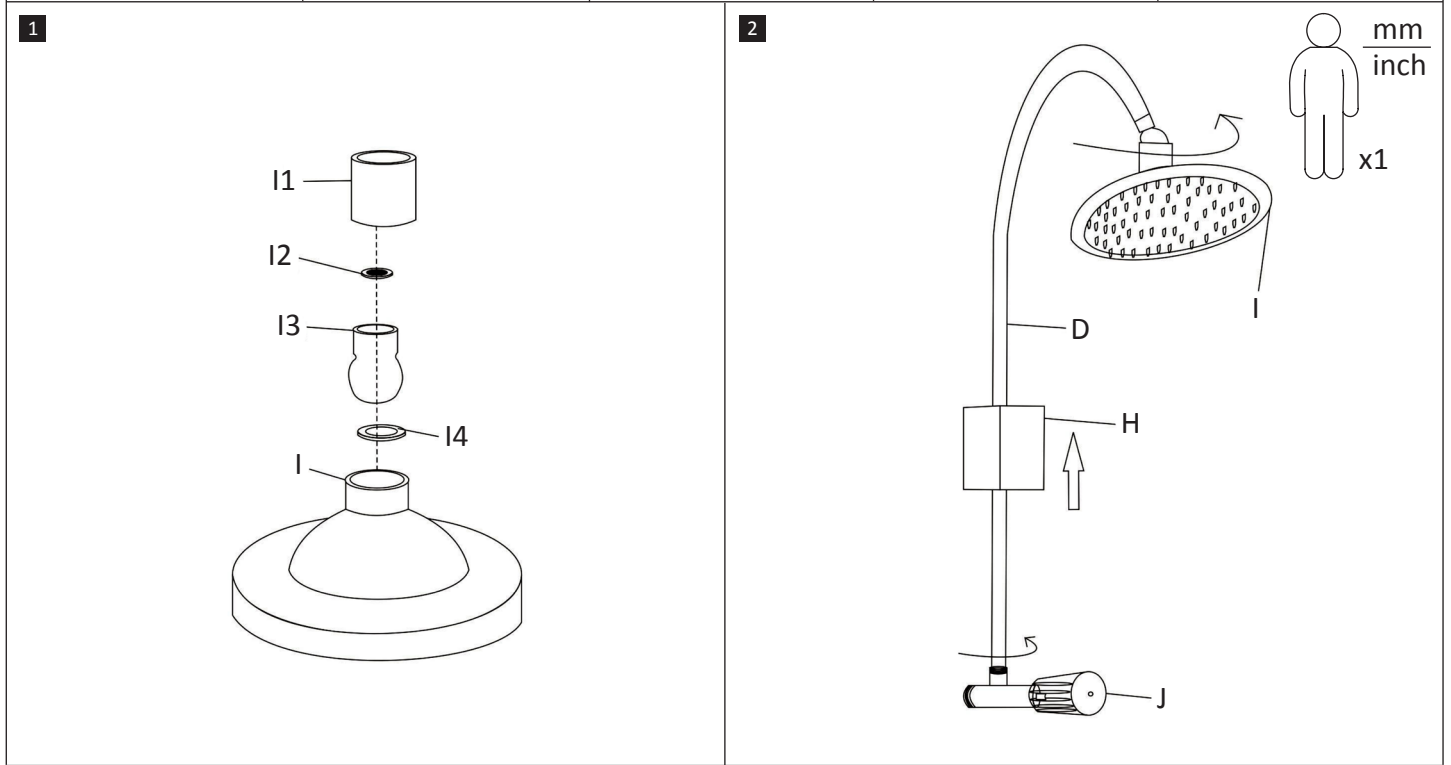
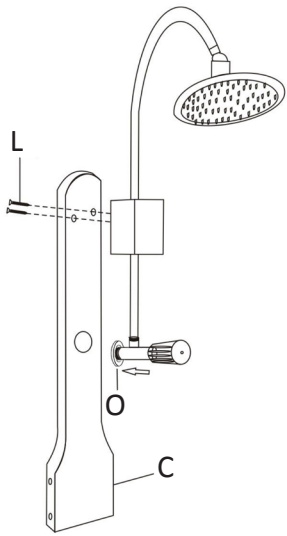
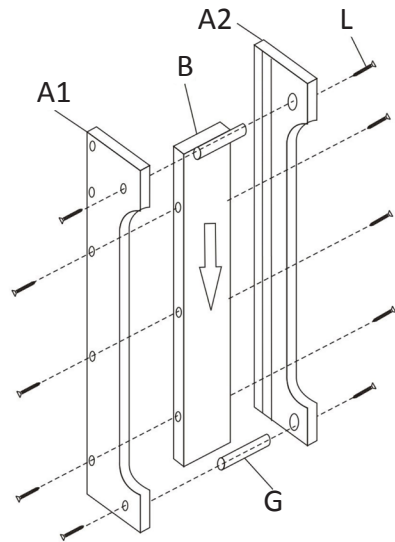

5

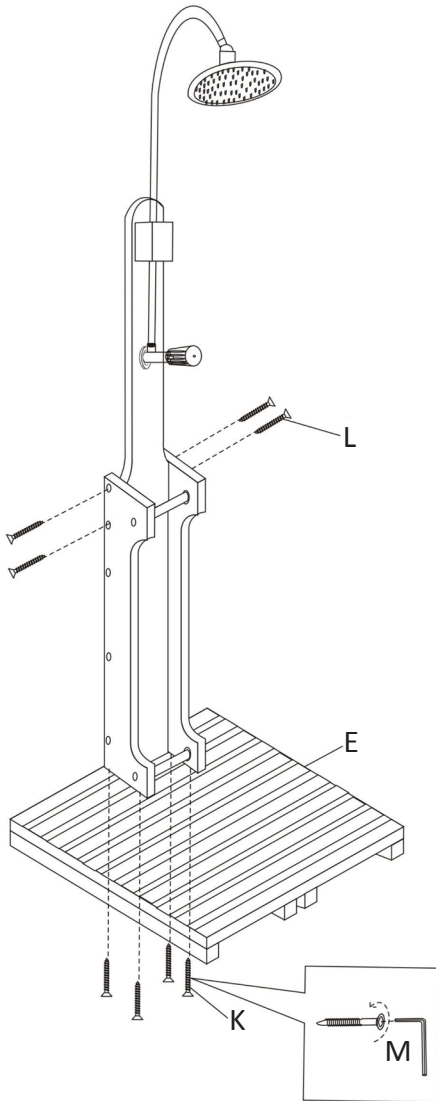

6

